



# LOGO STYLE GUIDE

January 21, 2009

# TABLE of CONTENTS

---

<b>TABLE of CONTENTS</b> .....	1
<b>STYLE GUIDE OVERVIEW</b> .....	3
<b>THE TEMESCAL VALLEY LOGO</b> .....	4
<b>THE TEMESCAL VALLEY MAIN LOGO</b> .....	5
<b>TEMESCAL VALLEY BLACK &amp; WHITE LOGO VARIATIONS</b> .....	6
<b>TEMESCAL VALLEY GRAYSCALE LOGO VARIATIONS</b> .....	7
<b>TEMESCAL VALLEY TYPEFACES</b> .....	8
<b>THE TEMESCAL VALLEY COLOR PALETTE</b> .....	9
<b>LOGO USEAGE APPLICATIONS</b> .....	10
<b>LOGO USEAGE APPLICATIONS   STATIONARY</b> .....	11
<b>LOGO USEAGE APPLICATIONS   LOGO PLACEMENT</b> .....	12
<b>LOGO USEAGE APPLICATIONS   DATA SHEETS, FLYERS, ETC.</b> .....	13
<b>LOGO USEAGE APPLICATIONS   DATA SHEETS, FLYERS, ETC.</b> .....	14
<b>LOGO USEAGE APPLICATIONS   ENVIRONMENTAL GRAPHICS</b> .....	15
<b>LOGO USEAGE APPLICATIONS   ENVIRONMENTAL GRAPHICS</b> .....	16
<b>LOGO USEAGE APPLICATIONS   ENVIRONMENTAL GRAPHICS</b> .....	17
<b>LEGAL NOTICES</b> .....	18

*September 2008*

---

Page Intentionally Blank



# STYLE GUIDE OVERVIEW

---

Every day, the Temescal Valley Logo will be noticed on communication material ranging from stationary to signage. Each impression represents the community of Temescal Valley and the County of Riverside. The logo and style guidelines unify communications and help them make a clear, strong, consistent message.

Each communication, through its content and presentation, provides information about the Temescal Valley image. Direct information is given through what is stated; indirect information is given through the clarity, tone, style, and professionalism with which the information is presented. The result of this dedication to excellence within the marketing communications will only lead to strengthening the image and character of Temescal Valley.

# THE TEMESCAL VALLEY LOGO

---

The Temescal Valley Logo has a 10 color CMYK design treatment. The logo is designed to be reproduced primarily in CMYK\*/color format.

However, PMS (Pantone Matching System) equivalents for these CMYK colors are supplied for the purposes of ensuring consistency of color reproduction

Ideally the logo will be used on a uniformly colored and patterned background for maximum impact and clarity. The logo will have a minimum of 1/3 X-Height white space around it.

\*Abbreviation for cyan, magenta, yellow and key (black), the 4 process colors, which combined together in varying proportions can be made to produce the full colour spectrum.

In order to maintain legibility of the Temescal Valley Logo, the minimum height dimension is 1/2", 1.28 centimeters, 3.0 picas, or 36 points on letterhead and similar printed materials.

Ideally the logo will be used on a white background on letterhead and similar printed materials for maximum impact and clarity. The logo will have a minimum of 1/4 X-Height white space around it.

When used on signage, walls and other elements of the streetscape, the background should be a uniformly colored and patterned background.

**Note:** Do not attempt to construct this logo design. Electronic files in PDF format will be provided.



# THE TEMESCAL VALLEY MAIN LOGO

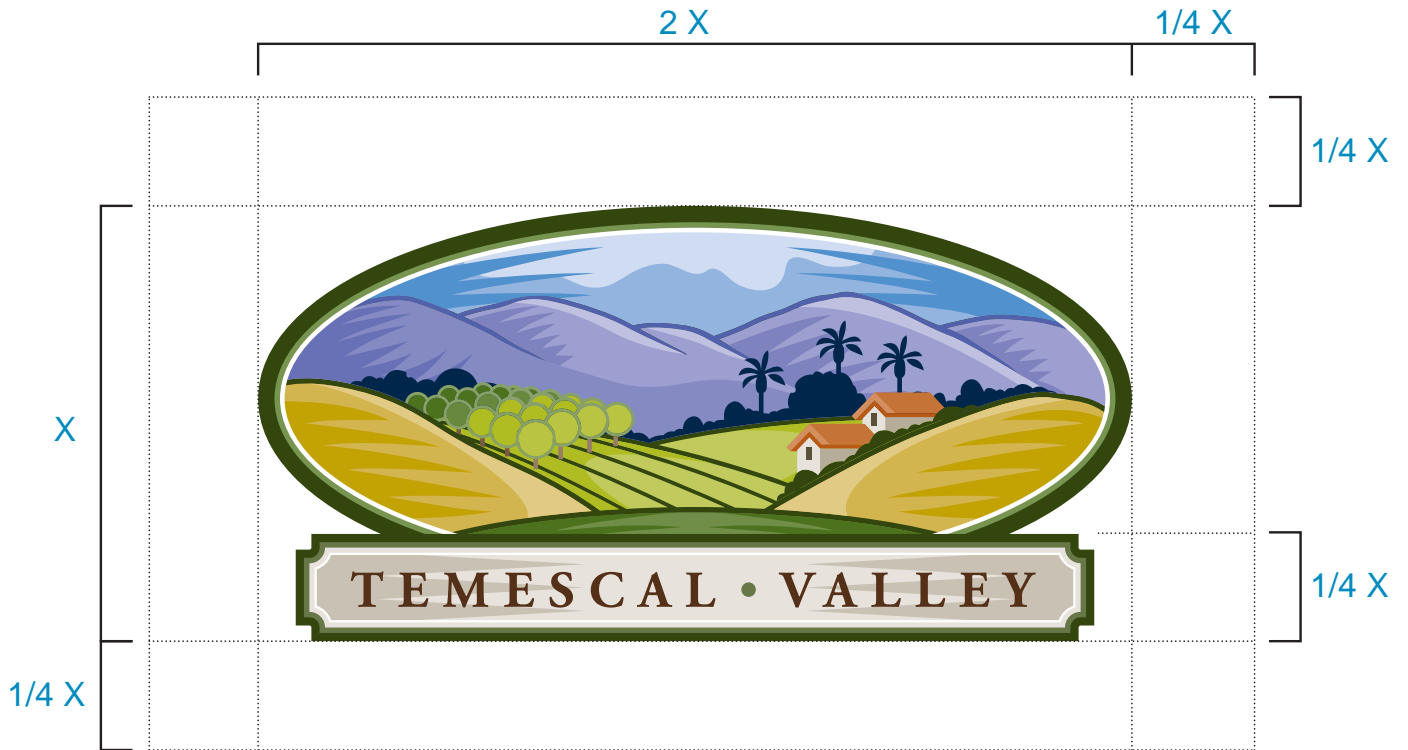

**PANTONE 583**  
 CMYK 23C.0M.100Y.17K  
 RGB 178R.187G.56B  
 HEX afbc21



**PANTONE 575**  
 CMYK 48C.0M.100Y.53K  
 RGB 89R.113G.42B  
 HEX 4b721d



**PANTONE 5743**  
 CMYK 33C.0M.85Y.82K  
 RGB 59R.71G.25B  
 HEX 33460d



**PANTONE 457**  
 CMYK 0C.15M.100Y.28K  
 RGB 185R.161G.39B  
 HEX c2a204



**PANTONE 1675**  
 CMYK 0C.67M.100Y.28K  
 RGB 163R.89G.33B  
 HEX b95915



**PANTONE 279**  
 CMYK 68C.34M.0Y.0K  
 RGB 104R.143G.201B  
 HEX 5091cd



**PANTONE 2725**  
 CMYK 77C.68M.0Y.0K  
 RGB 87R.97G.168B  
 HEX 5261ac



**PANTONE 5395**  
 CMYK 100C.44M.0Y.76K  
 RGB 0R.42G.76B  
 HEX 00274c



**PANTONE 476**  
 CMYK 57C.80M.100Y.45K  
 RGB 77R.51G.32B  
 HEX 53301a



**PANTONE BLACK**  
 CMYK 0C.13M.49Y.98K  
 RGB 39R.32G.13B  
 HEX 261c02

## TEMESCAL VALLEY BLACK & WHITE LOGO VARIATIONS

---



### ONE COLOR (MONOCHROMATIC)

For applications where only one color is permitted. White areas/background color indicates no ink.



Example of monochromatic logo on a colored background.



Example of monochromatic logo on a white background.

## TEMESCAL VALLEY GRAYSCALE LOGO VARIATIONS

---

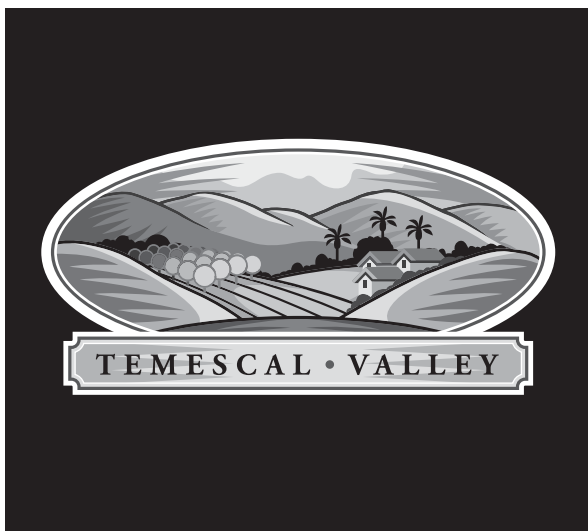

### GRAYSCALE

For better legibility and clarity please use the grayscale version of the logo depending on the nature of the background.



Example of grayscale version of logo on colored background.



Example of grayscale version of logo on white background.



# TEMESCAL VALLEY TYPEFACES

---

Savoy is the preferred font to be used in conjunction with the Temescal Valley logo. This typeface is recommended for display text (headlines) and body copy accompanying the logo.

Savoy

A B C D E F G H I J K L M N O P Q R S T U V W X Y Z  
a b c d e f g h i j k l m n o p q r s t u v w x y z

Savoy Bold

A B C D E F G H I J K L M N O P Q R S T U V W X Y Z  
a b c d e f g h i j k l m n o p q r s t u v w x y z

Savoy Italic

*A B C D E F G H I J K L M N O P Q R S T U V W X Y Z*  
*a b c d e f g h i j k l m n o p q r s t u v w x y z*

Savoy Small Caps

A B C D E F G H I J K L M N O P Q R S T U V W X Y Z  
A B C D E F G H I J K L M N O P Q R S T U V W X Y Z

Savoy Small Caps Bold

A B C D E F G H I J K L M N O P Q R S T U V W X Y Z  
A B C D E F G H I J K L M N O P Q R S T U V W X Y Z

# THE TEMESCAL VALLEY COLOR PALETTE

---

## PANTONE 583

CMYK 23C.0M.100Y.17K  
RGB 178R.187G.56B  
HEX afbc21

## PANTONE 279

CMYK 68C.34M.0Y.0K  
RGB 104R.143G.201B  
HEX 5091cd

## PANTONE 575

CMYK 48C.0M.100Y.53K  
RGB 89R.113G.42B  
HEX 4b721d

## PANTONE 2725

CMYK 77C.68M.0Y.0K  
RGB 87R.97G.168B  
HEX 5261ac

## PANTONE 5743

CMYK 33C.0M.85Y.82K  
RGB 59R.71G.25B  
HEX 33460d

## PANTONE 5395

CMYK 100C.44M.0Y.76K  
RGB 0R.42G.76B  
HEX 00274c

## PANTONE 457

CMYK 0C.15M.100Y.28K  
RGB 185R.161G.39B  
HEX c2a204

## PANTONE 476

CMYK 57C.80M.100Y.45K  
RGB 77R.51G.32B  
HEX 53301a

## PANTONE 1675

CMYK 0C.67M.100Y.28K  
RGB 163R.89G.33B  
HEX b95915

## PANTONE BLACK

CMYK 0C.13M.49Y.98K  
RGB 39R.32G.13B  
HEX 261c02

# LOGO USAGE APPLICATIONS

---

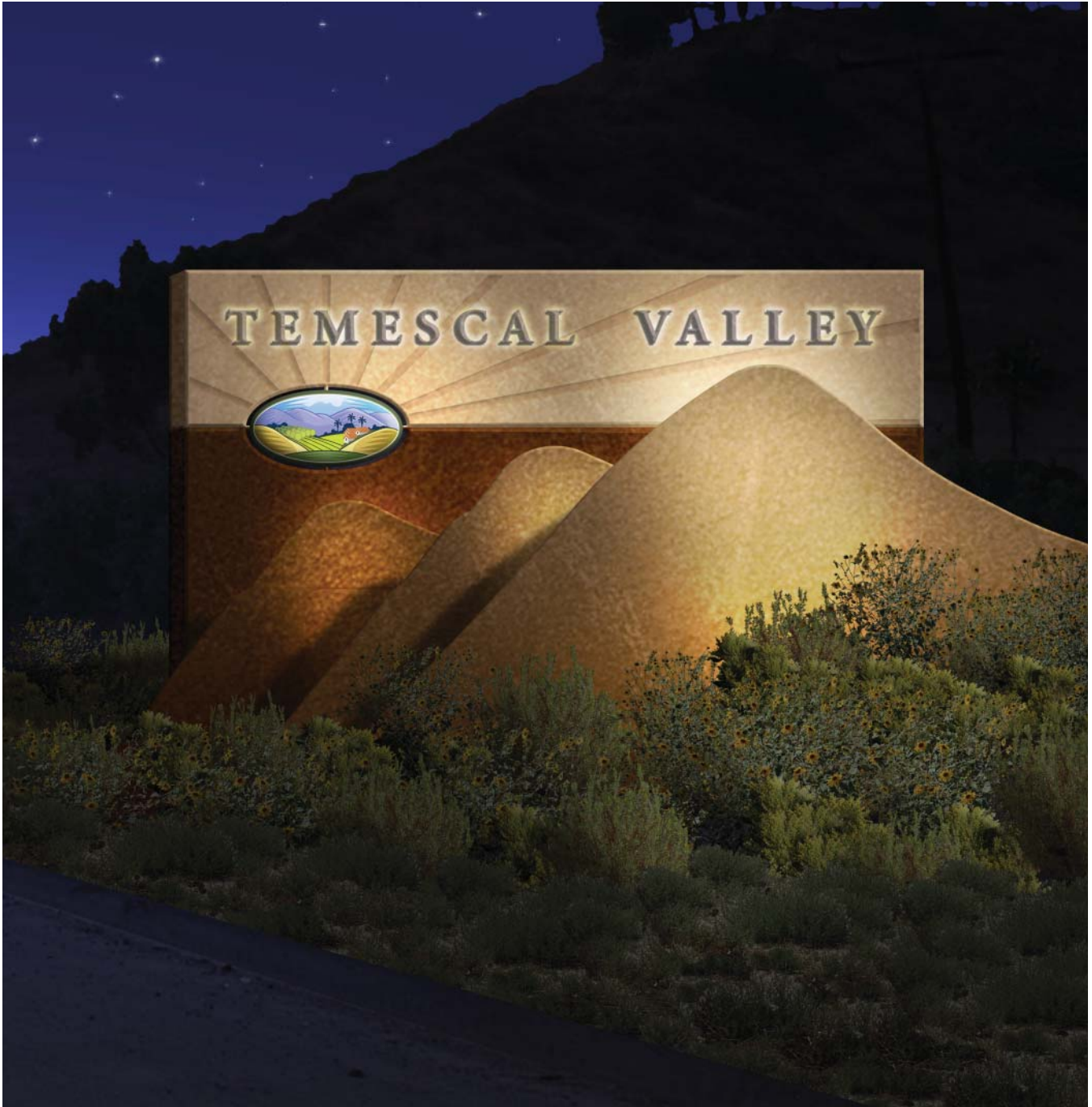

TEMESCAL VALLEY MONUMENT SIGN - NIGHT SCENE

# LOGO USAGE APPLICATIONS | STATIONARY

The following information serves as a guide to creating new designs and layouts. A hierarchy of information has been established, through the use of character styles, sizes and secondary graphics. This must be carried through in all future communications to maintain consistency.

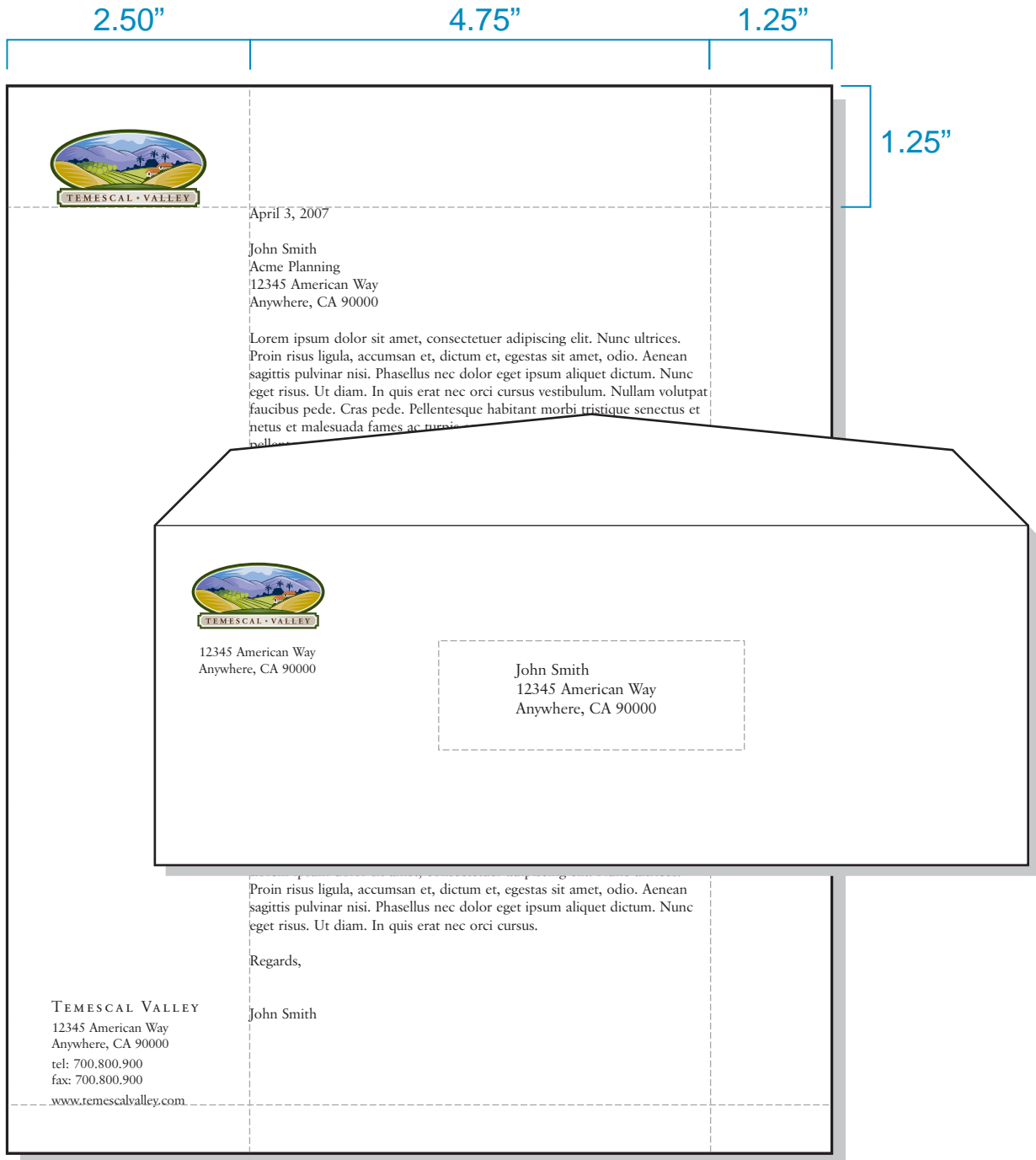

# LOGO USAGE APPLICATIONS | LOGO PLACEMENT

---

For most applications the optimum placement for the Temescal Valley Logo is the top left corner, or right corner of the layout with 1x-height white space around it, or a reasonable margin.

If required, the logo placements shown below are also acceptable. However for signage and large applications the logo must be placed at least 3 feet from the ground.

The size and location of the logo must be in proportion to the required size of signage text and form.

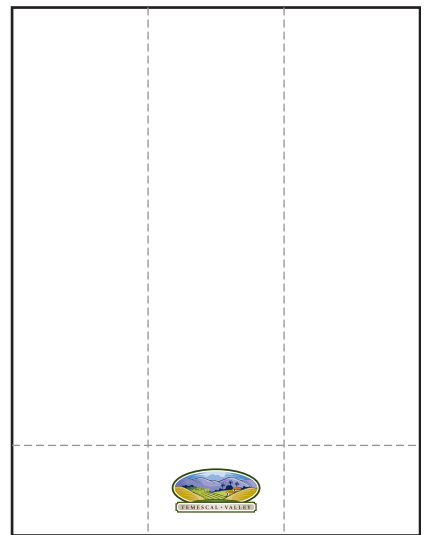
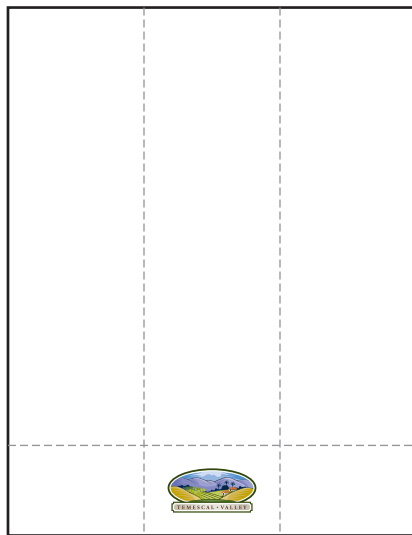
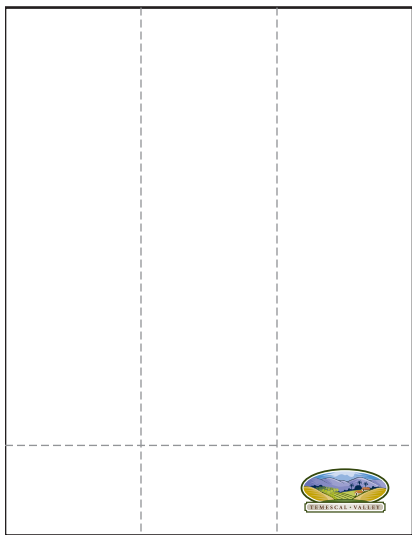
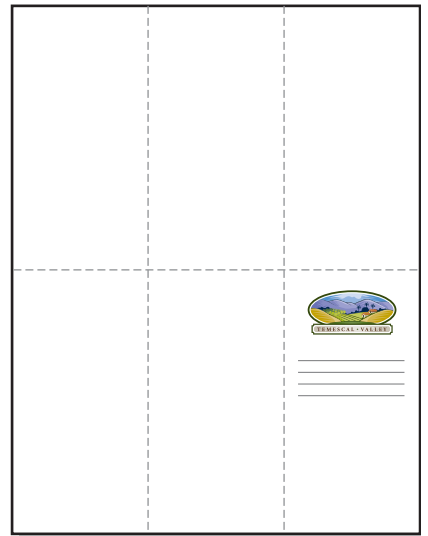
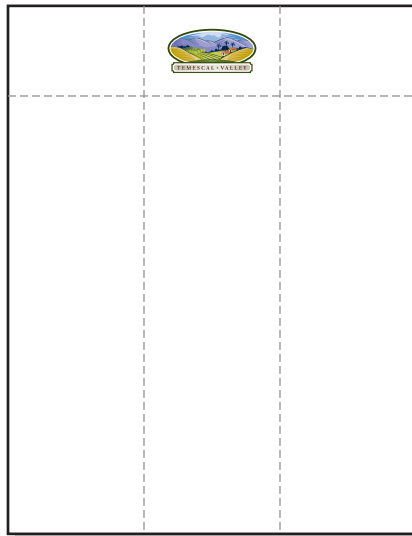
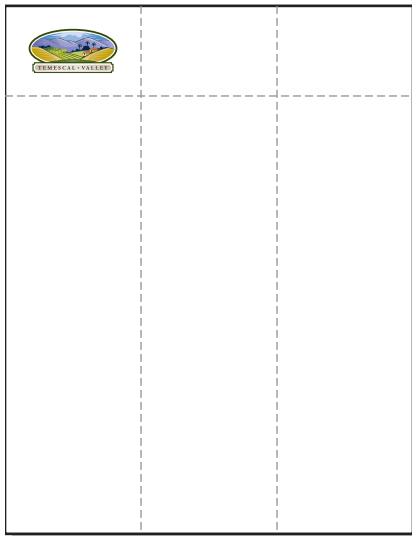

# LOGO USAGE APPLICATIONS | DATA SHEETS, FLYERS, ETC.



**SHEET TITLE** | SECONDARY INFORMATION

*Cras congue orci. Etiam semper risus at neque. Donec porttitor laoreet quam. Morbi at enim non elit aliquam aliquam.*

Cras congue orci. Etiam semper risus at neque. Donec porttitor laoreet elit aliquam aliquam.

Morbi at enim non elit aliquam aliquam. Sed tincidunt eros ac nulla consectetur adipiscing elit.

Etiam cursus. Lorem ipsum dolor sit amet, consectetur dolor sit amet adipiscing elit.

Pellentesque habitant morbi tristique senectus et netus et malesuada fames ac turpis egestas.

Cras congue orci. Etiam semper risus at neque. Donec porttitor laoreet elit aliquam aliquam.



Vivamus porta nonummy lectus. Suspendisse eget eros in odio mollis elementum. Duis magna mi, pharetra non, pellentesque et, pulvinar quis, lacus. Mauris lacus massa, facilisis lacinia, placerat quis, luctus sed, nulla. Quisque venenatis. Proin in sem vitae turpis tempor aliquam.

Lorem ipsum dolor sit amet, consectetur adipiscing elit. Nunc ultrices. Proin risus ligula, accumsan et, dictum et, egestas sit amet, odio. Aenean sagittis pulvinar nisi. Phasellus nec dolor eget ipsum aliquet dictum. Nunc eget risus. Ut diam. In quis erat nec orci cursus vestibulum. Nullam volutpat faucibus pede. Cras pede. Pellentesque habitant morbi tristique senectus et netus et malesuada fames ac turpis egestas. Aliquam erat volutpat. Vivamus pellentesque tortor vel quam. Nam nisl. Mauris a arcu. Fusce eget quam in pede lacinia tincidunt. Nunc ligula. Nullam congue.

Aliquam erat volutpat. Vivamus pellentesque tortor vel quam. Nam nisl. Mauris a arcu. Fusce eget quam in pede lacinia tincidunt. Nunc ligula. Nullam congue.

Cras congue orci. Etiam semper risus at neque. Donec porttitor laoreet quam. Morbi at enim non elit aliquam aliquam. Sed tincidunt eros ac nulla. Etiam cursus. Lorem ipsum dolor sit amet, consectetur adipiscing elit. Sed posuere pede cursus libero. iaculis nisl in arcu. Aliquam ac pede. Vestibulum quis massa et libero tincidunt sollicitudin. Etiam nibh. Praesent augue turpis, commodo in, sagittis sed, ultrices eu, erat. Cras vestibulum nibh non sem.

Cras congue orci. Etiam semper risus at neque. Donec porttitor laoreet quam. Morbi at enim non elit aliquam aliquam. Sed tincidunt eros ac nulla. Etiam cursus. Lorem ipsum dolor sit amet, consectetur adipiscing elit. Pellentesque habitant morbi tristique senectus et netus et malesuada fames ac turpis egestas.

---

TEMESCAL VALLEY | 12345 American Way | Anywhere Town, California 90000

● **Section 1**  
Application Logo  
Headline

● **Section 2**  
Key Feature/Message  
Color: Pantone 131 U  
Related Imagery

● **Section 3**  
Introduction  
Body Copy

● **Section 4**  
Footer information

# LOGO USAGE APPLICATIONS | DATA SHEETS, FLYERS, ETC.



**SHEET TITLE |** SECONDARY INFORMATION

*Cras congue orci. Etiam semper risus at neque. Donec porttitor laoreet quam. Morbi at enim non elit aliquam aliquam.*

Cras congue orci. Etiam semper risus at neque. Donec porttitor laoreet elit aliquam aliquam.

Morbi at enim non elit aliquam aliquam. Sed tincidunt eros ac nulla consectetur adipiscing elit.

Etiam cursus. Lorem ipsum dolor sit amet, consectetur dolor sit amet adipiscing elit.

Pellentesque habitant morbi tristique senectus et netus et malesuada fames ac turpis egestas.

Cras congue orci. Etiam semper risus at neque. Donec porttitor laoreet elit aliquam aliquam.



Vivamus porta nonummy lectus. Suspendisse eget eros in odio mollis elementum. Duis magna mi, pharetra non, pellentesque et, pulvinar quis, lacus. Mauris lacus massa, facilisis lacinia, placerat quis, luctus sed, nulla. Quisque venenatis. Proin in sem vitae turpis tempor aliquam.

Lorem ipsum dolor sit amet, consectetur adipiscing elit. Nunc ultrices. Proin risus ligula, accumsan et, dictum et, egestas sit amet, odio. Aenean sagittis pulvinar nisi. Phasellus nec dolor eget ipsum aliquet dictum. Nunc eget risus. Ut diam. In quis erat nec orci cursus vestibulum. Nullam volutpat faucibus pede. Cras pede. Pellentesque habitant morbi tristique senectus et netus et malesuada fames ac turpis egestas. Aliquam erat volutpat. Vivamus pellentesque tortor vel quam. Nam nisl. Mauris a arcu. Fusce eget quam in pede lacinia tincidunt. Nunc ligula. Nullam congue.

Cras congue orci. Etiam semper risus at neque. Donec porttitor laoreet quam. Morbi at enim non elit aliquam aliquam. Sed tincidunt eros ac nulla. Etiam cursus. Lorem ipsum dolor sit amet, consectetur adipiscing elit. Sed posuere pede cursus libero. iaculis nisl in arcu. Aliquam ac pede. Vestibulum quis massa et libero tincidunt sollicitudin. Etiam nibh. Praesent augue turpis, commodo in, sagittis sed, ultrices eu, erat. Cras vestibulum nibh non sem.

TEMESCAL VALLEY | 12345 American Way | Anywhere Town, California 90000

Section 1  
Application Logo  
Headline

Section 2  
Key Feature/Message  
Color: Pantone 463 U  
Related Imagery

Section 3  
Introduction  
Body Copy

Section 4  
Footer information

# LOGO USEAGE APPLICATIONS | ENVIRONMENTAL GRAPHICS

As is evident by the examples shown below, the logo can be presented and applied to various materials without altering the colors or the main graphic language that makes up the logo. This way the integrity of the logo can be maintained while still portraying the unique Temescal Valley brand.

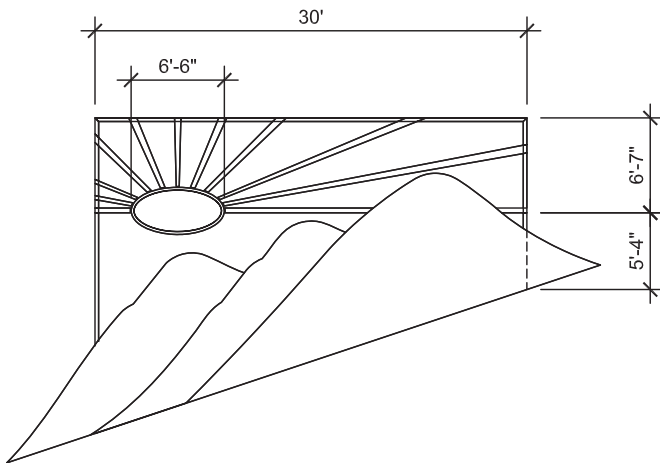
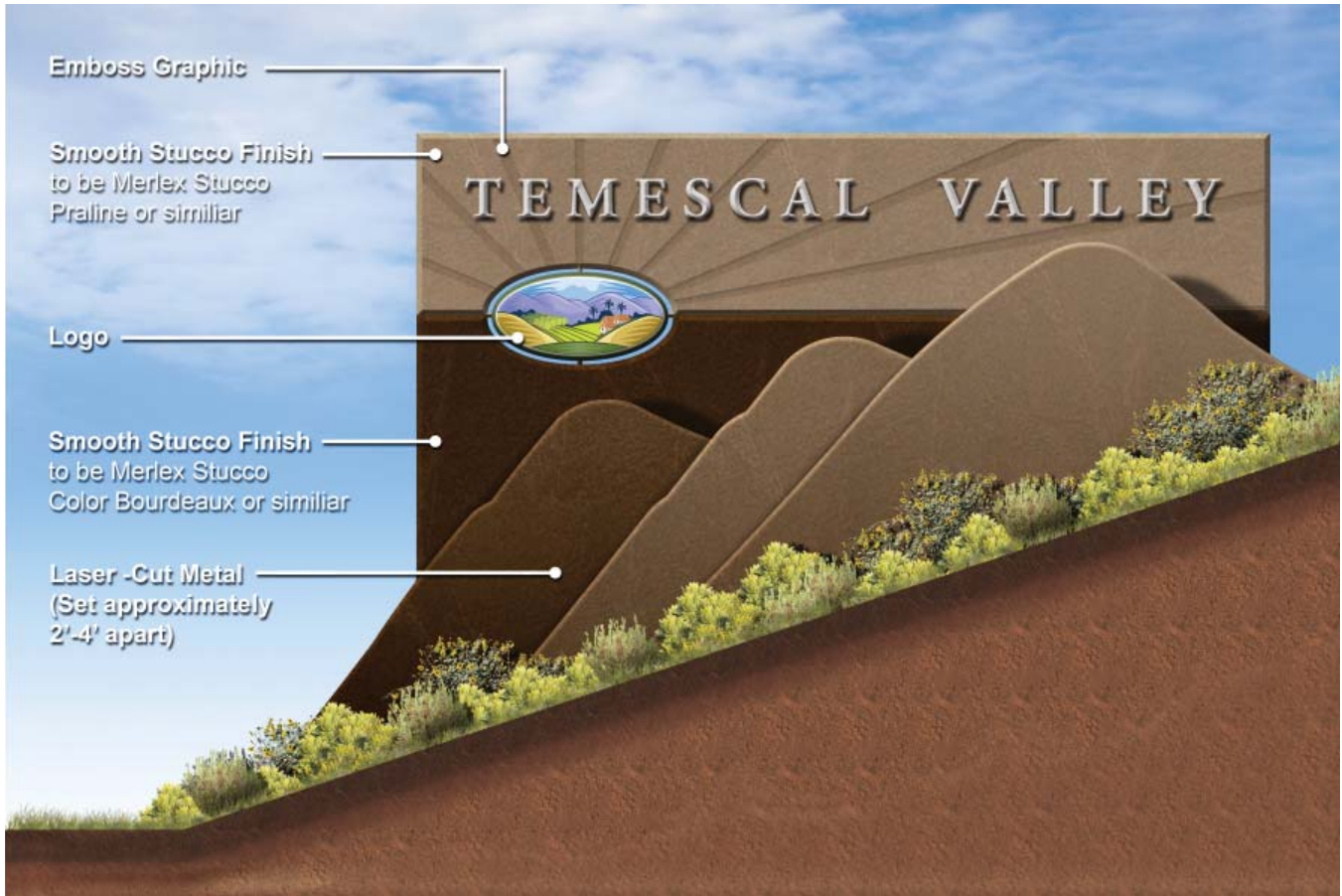

**Note:** It may be necessary to adjust dimensions to accommodate site conditions or engineering. Keep proportions the same as shown.

**TEMESCAL VALLEY MONUMENT SIGN**



# LOGO USAGE APPLICATIONS | ENVIRONMENTAL GRAPHICS



**Note:** It may be necessary to adjust dimensions to accommodate site conditions or engineering. Keep proportions the same as shown.

## TEMESCAL VALLEY SMALL MONUMENT SIGN

**LOGO USEAGE APPLICATIONS | ENVIRONMENTAL GRAPHICS**

---



**EXAMPLE OF LOGO APPLICATION ON STREET SIGN**

# LEGAL NOTICES

---

The County of Riverside is the sole and exclusive owner of the Logo. Any person, company or governmental entity who desires to use the Logo must first obtain Riverside County's prior, express written consent. If consent is given, then any party who uses the Logo agrees that they shall not change or alter the design, colors, or configuration of the Logo in any way, and shall use the logo consistent with the consent given.

Contact:

Riverside County Planning Department  
(959) 955-3200  
4080 Lemon Street, 9th Floor  
Riverside, CA 92502

If not attached to this Style Guide, a scalable electronic file in PDF format will be provided by the County. This file must be used to lay out the logo. Do not attempt to lay out logo in a freehand manner.