

Project Specific Water Quality Management Plan

A Template for Projects located within the **Santa Ana Watershed** Region of Riverside County

Project Title: Phelan-Seaton

Development No: TBD

Design Review/Case No: PPT210133

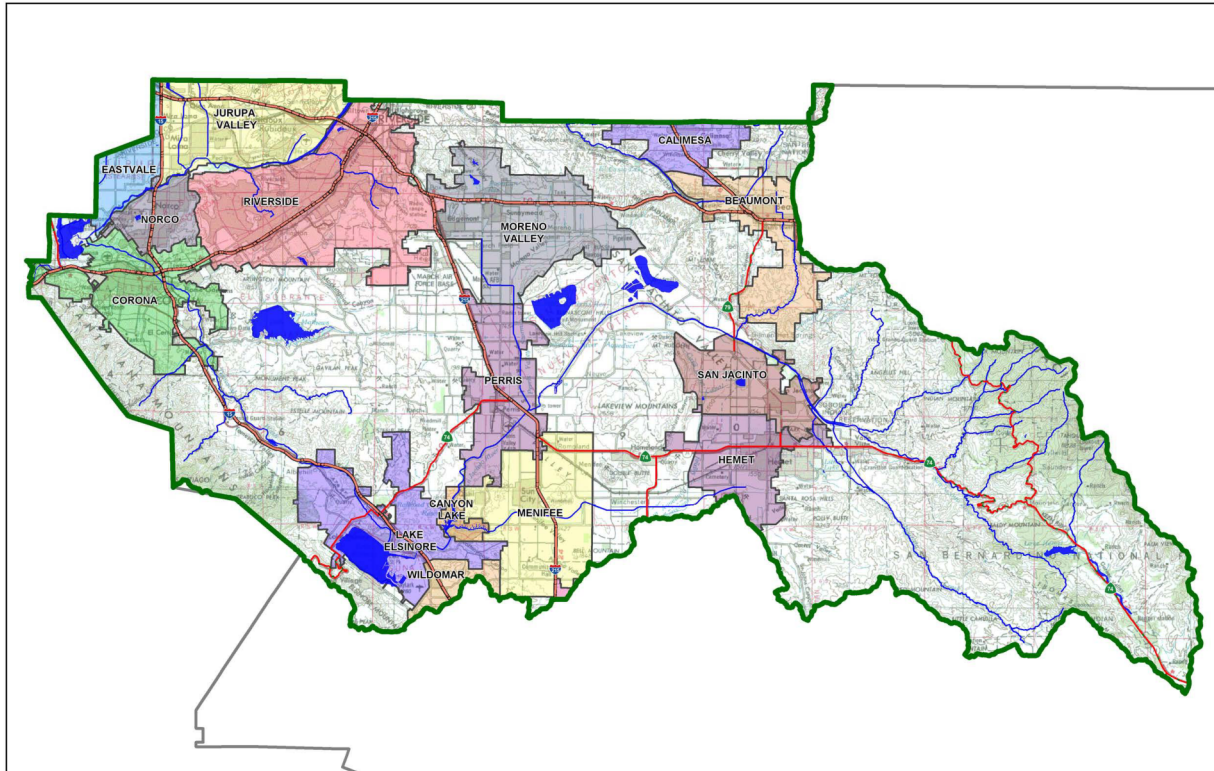

- Preliminary
- Final

Original Date Prepared: July 7, 2021

Revision Date(s): September 24, 2021; January 21, 2022

Prepared for Compliance with
*Regional Board Order No. **R8-2010-0033***

Template revised June 30, 2016

Contact Information:

Prepared for:

Phelan Development Company
450 Newport Center Drive, Suite 405
Newport Beach, CA 92660
(949) 720-8050

Prepared by:

SDH & Associates, Inc.
27363 Via Industria
Temecula, CA 92590
(951) 683-3691

A Brief Introduction

This Project-Specific WQMP Template for the **Santa Ana Region** has been prepared to help guide you in documenting compliance for your project. Because this document has been designed to specifically document compliance, you will need to utilize the WQMP Guidance Document as your “how-to” manual to help guide you through this process. Both the Template and Guidance Document go hand-in-hand, and will help facilitate a well prepared Project-Specific WQMP. Below is a flowchart for the layout of this Template that will provide the steps required to document compliance.

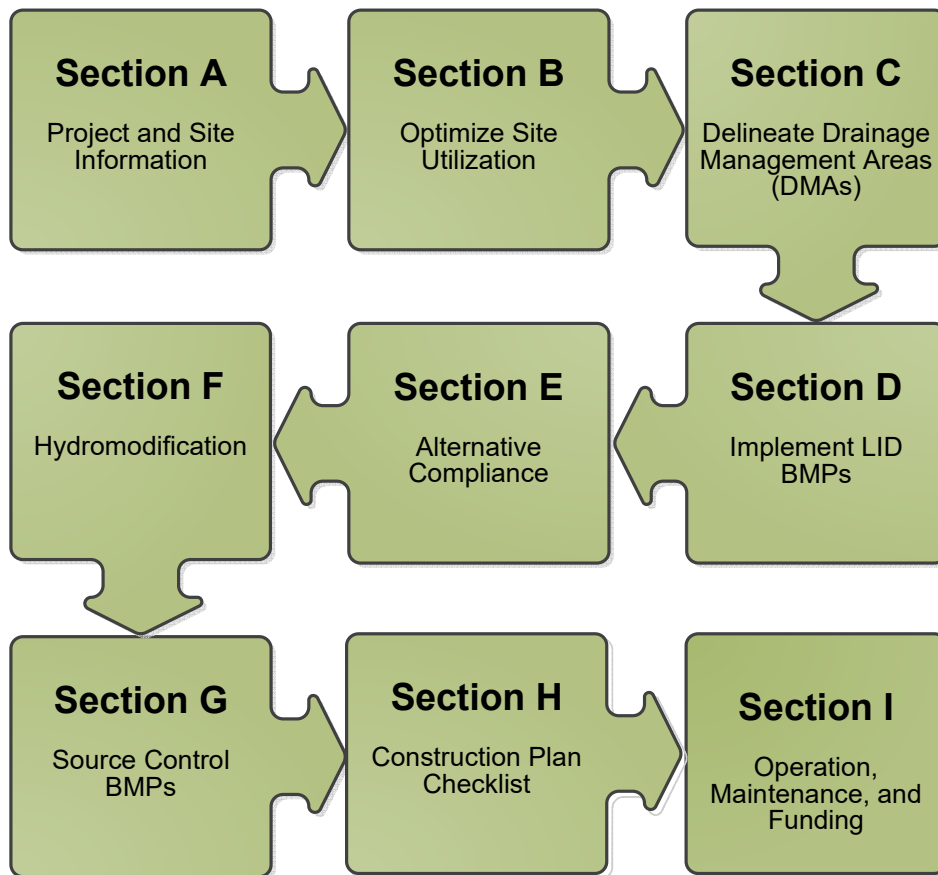

OWNER'S CERTIFICATION

This Project-Specific Water Quality Management Plan (WQMP) has been prepared for Phelan Development Company by SDH & Associates, Inc. for the Phelan - Seaton project (PPT210133).

This WQMP is intended to comply with the requirements of Riverside County for County Ordinance No. 754, which includes the requirement for the preparation and implementation of a Project-Specific WQMP.

The undersigned, while owning the property/project described in the preceding paragraph, shall be responsible for the implementation and funding of this WQMP and will ensure that this WQMP is amended as appropriate to reflect up-to-date conditions on the site. In addition, the property owner accepts responsibility for interim operation and maintenance of Stormwater BMPs until such time as this responsibility is formally transferred to a subsequent owner. This WQMP will be reviewed with the facility operator, facility supervisors, employees, tenants, maintenance and service contractors, or any other party (or parties) having responsibility for implementing portions of this WQMP. At least one copy of this WQMP will be maintained at the project site or project office in perpetuity. The undersigned is authorized to certify and to approve implementation of this WQMP. The undersigned is aware that implementation of this WQMP is enforceable under the Riverside County Water Quality Ordinance No. 754.

"I, the undersigned, certify under penalty of law that the provisions of this WQMP have been reviewed and accepted and that the WQMP will be transferred to future successors in interest."

Owner's Signature

Date

Owner's Printed Name

Owner's Title/Position

PREPARER'S CERTIFICATION

"The selection, sizing and design of stormwater treatment and other stormwater quality and quantity control measures in this plan meet the requirements of Regional Water Quality Control Board Order No. **R8-2010-0033** and any subsequent amendments thereto."

Preparer's Signature

Date

Nobu Murakami

Preparer's Printed Name

Water Resources Engineer

Preparer's Title/Position

Preparer's Licensure:

Table of Contents

Section A: Project and Site Information.....	6
A.1 Maps and Site Plans.....	8
A.2 Identify Receiving Waters.....	8
A.3 Additional Permits/Approvals required for the Project:	9
Section B: Optimize Site Utilization (LID Principles)	10
Section C: Delineate Drainage Management Areas (DMAs).....	12
Section D: Implement LID BMPs	14
D.1 Infiltration Applicability	14
D.2 Harvest and Use Assessment.....	15
D.3 Bioretention and Biotreatment Assessment	17
D.4 Feasibility Assessment Summaries	18
D.5 LID BMP Sizing	19
Section E: Alternative Compliance (LID Waiver Program)	21
E.1 Identify Pollutants of Concern	22
E.2 Stormwater Credits	23
E.3 Sizing Criteria.....	23
E.4 Treatment Control BMP Selection	24
Section F: Hydromodification	25
F.1 Hydrologic Conditions of Concern (HCOC) Analysis.....	25
F.2 HCOC Mitigation.....	26
Section G: Source Control BMPs.....	27
Section H: Construction Plan Checklist	30
Section I: Operation, Maintenance and Funding.....	31

List of Tables

Table A.1 Identification of Receiving Waters.....	8
Table A.2 Other Applicable Permits.....	9
Table C.1 DMA Classifications.....	12
Table C.2 Type 'A', Self-Treating Areas.....	12
Table C.3 Type 'B', Self-Retaining Areas.....	12
Table C.4 Type 'C', Areas that Drain to Self-Retaining Areas.....	13
Table C.5 Type 'D', Areas Draining to BMPs.....	13
Table D.1 Infiltration Feasibility.....	14
Table D.2 LID Prioritization Summary Matrix.....	18
Table D.3 DCV Calculations for LID BMPs.....	19
Table D.4 DCV Calculations for LID BMPs.....	20
Table E.1 Potential Pollutants by Land Use Type.....	22
Table E.2 Water Quality Credits.....	23
Table E.3 Treatment Control BMP Sizing.....	23
Table E.4 Treatment Control BMP Selection.....	24
Table F.1 Hydrologic Conditions of Concern Summary.....	25
Table G.1 Permanent and Operational Source Control Measures.....	27
Table H.1 Construction Plan Cross-reference.....	30

List of Appendices

Appendix 1: Maps and Site Plans

Appendix 2: Construction Plans

Appendix 3: Soils Information

Appendix 4: Historical Site Conditions

Appendix 5: LID Infeasibility

Appendix 6: BMP Design Details

Appendix 7: Hydromodification

Appendix 8: Source Control

Appendix 9: O&M

Appendix 10: Educational Materials

Section A: Project and Site Information

PROJECT INFORMATION	
Type of Project:	Industrial
Planning Area:	Mead Valley Area Plan (MVAP)
Community Name:	Community of Gavilan Hills
Development Name:	Phelan-Seaton
PROJECT LOCATION	
Latitude & Longitude (DMS): 33°50'8.10"N, 117°15'38.57"W	
Project Watershed and Sub-Watershed: Santa Ana (Watershed) Perris Reservoir (Sub Watershed)	
Gross Acres: ~17.5 acres (parcel); ~16.3 acres of on-site drainage management area	
APN(s): 317-140-019, 020, 005, 004, 028, 044, 045, and 046	
Map Book and Page No.: Book 96 Page 86 of Parcel Maps	
PROJECT CHARACTERISTICS	
Proposed or Potential Land Use(s)	Light Industrial
Proposed or Potential SIC Code(s)	1541
Area of Impervious Project Footprint (SF)	596,426 SF
Total Area of <u>proposed</u> Impervious Surfaces within the Project Footprint (SF)/or Replacement	596,426 SF
Does the project consist of offsite road improvements?	<input checked="" type="checkbox"/> Y <input type="checkbox"/> N
Does the project propose to construct unpaved roads?	<input type="checkbox"/> Y <input checked="" type="checkbox"/> N
Is the project part of a larger common plan of development (phased project)?	<input type="checkbox"/> Y <input checked="" type="checkbox"/> N
EXISTING SITE CHARACTERISTICS	
Total area of <u>existing</u> Impervious Surfaces within the Project limits Footprint (SF)	~266,805 SF (~35% IMP)
Is the project located within any MSHCP Criteria Cell?	<input type="checkbox"/> Y <input checked="" type="checkbox"/> N
If so, identify the Cell number:	N/A
Are there any natural hydrologic features on the project site?	<input type="checkbox"/> Y <input checked="" type="checkbox"/> N
Is a Geotechnical Report attached?	<input checked="" type="checkbox"/> Y <input type="checkbox"/> N
If no Geotech. Report, list the NRCS soils type(s) present on the site (A, B, C and/or D)	See Appendix 3 – NRCS Soil Types A, B, & C
What is the Water Quality Design Storm Depth for the project?	0.58 inch

Phelan Development Company is proposing to develop an industrial tilt-up warehouse building and associated parking as part of this project, which is located at the southeast corner of the intersection of Cajalco Expressway and Seaton Avenue in the unincorporated portion of the Riverside County, California. A vicinity map is provided in Appendix 1 of this report for reference purpose. The site (parcel) is approximately 17.5 acres (gross area) with approximately 16.3 acres of on-site drainage management area. The proposed building footprint is approximately 350,481 square feet (S.F.). The project will have 240 spaces for parking as well as 66 spaces for trailer parking. The overall on-site impervious surface footprint anticipated for this project is approximately 596,426 S.F. The existing site consists of residential homes and automobile storage/parking in the northerly portion of the site and vacant/undeveloped land in the remaining portion of the site. It appears that the vegetation has been cleared over times in the southerly portion.

In the existing condition, the site is generally divided into two portions in terms of drainage with a west-east ridge line. The southerly half of the site consists of open/undeveloped space and runoff from this area generally in a southeasterly direction. The northerly half of the site consists of a few existing residential homes along with areas for automobile storage/parking. Runoff in the northerly half of the site drains generally in a northeasterly direction towards Cajalco Road. Runoff from the site outlets at two areas of interest (i.e. – southerly edge and

northeasterly corners of the site) and eventually connect into downstream existing storm drain systems. Runoff from the site eventually discharges into the existing District's Perris Valley Channel, which ultimately discharges to Canyon Lake and then Lake Elsinore.

In the post-development condition, the proposed improvements will consist of hardscape areas such as roof, asphalt, concrete, and ornamental landscape areas. The post-project drainage characteristic will be maintained as similar to the existing condition.

In order to comply with the County of Riverside and Santa Ana Region's permanent storm water requirements and to be consistent with the existing hydrologic/drainage characteristic, best management practices (BMPs) are proposed at two locations on-site.

In support of the infiltration feasibility for the proposed permanent storm water BMP, a geotechnical investigation including infiltration testing was provided. A copy of the geotechnical report is included in Appendix 3. One of the infiltration testing results provided by the project-specific geotechnical engineer show 0.2 inch/hour, which is below the infiltration feasibility threshold of 1.6 inch/hour per the Santa Ana Region WQMP guidance document. While other infiltration testing results show relatively higher rates; however, they were conducted at relatively shallower depths and the lowest rate was considered for the BMP design purpose. Therefore, it was determined that infiltration is not technically feasible for the project. As such, two (2) bioretention facilities are proposed for this project. Two (2) bioretention facilities are proposed near the northeasterly and southeasterly corners of the project.

A.1 Maps and Site Plans

When completing your Project-Specific WQMP, include a map of the local vicinity and existing site. In addition, include all grading, drainage, landscape/plant palette and other pertinent construction plans in Appendix 2. At a **minimum**, your WQMP Site Plan should include the following:

- Drainage Management Areas
- Proposed Structural BMPs
- Drainage Path
- Drainage Infrastructure, Inlets, Overflows
- Source Control BMPs
- Buildings, Roof Lines, Downspouts
- Impervious Surfaces
- Standard Labeling
- BMP Locations (Lat/Long)

Use your discretion on whether or not you may need to create multiple sheets or can appropriately accommodate these features on one or two sheets. Keep in mind that the Co-Permittee plan reviewer must be able to easily analyze your project utilizing this template and its associated site plans and maps.

A.2 Identify Receiving Waters

Using Table A.1 below, list in order of upstream to downstream, the receiving waters that the project site is tributary to. Continue to fill each row with the Receiving Water's 303(d) listed impairments (if any), designated beneficial uses, and proximity, if any, to a RARE beneficial use. Include a map of the receiving waters in Appendix 1.

Table A.1 Identification of Receiving Waters

Receiving Waters	EPA Approved 303(d) List Impairments	Designated Beneficial Uses	Proximity to RARE Beneficial Use
Perris Valley Storm Drain	N/A	N/A	San Jacinto River Rach 3 (downstream).
San Jacinto River Reach 3 – Canyon Lake to Nuevo Road (HU#802.11)	None	MUN, AGR, GWR, REC1, REC2, WARM, WILD, RARE	This river reach has existing or potential RARE beneficial use.
Canyon Lake (HU#802.11, 802.12)	Nutrients, Pathogens TMDL Completed - Nutrients	MUN, AGR, GWR, REC1, REC2, COMM, WARM, WILD	San Jacinto River Reaches 1 (downstream).
San Jacinto River Rach 1 (HU#802.32, 802.31)	None	MUN, AGR, GWR, REC1, REC2, WARM, WILD, RARE	This river reach has existing or potential RARE beneficial use.
Lake Elsinore (HU#802.31)	Nutrients, Organic Enrichment/Low Dissolved Oxygen, PCBs, Sediment Toxicity, Unknown Toxicity TMDL Completed – Nutrients, Organic Enrichment/Low Dissolved Oxygen	MUN, REC1, REC2, COMM, WARM, WILD, RARE	The lake has existing or potential RARE beneficial use.

A.3 Additional Permits/Approvals required for the Project:

Table A.2 Other Applicable Permits

Agency	Permit Required	
State Department of Fish and Game, 1602 Streambed Alteration Agreement	<input type="checkbox"/> Y	<input checked="" type="checkbox"/> N
State Water Resources Control Board, Clean Water Act (CWA) Section 401 Water Quality Cert.	<input type="checkbox"/> Y	<input checked="" type="checkbox"/> N
US Army Corps of Engineers, CWA Section 404 Permit	<input type="checkbox"/> Y	<input checked="" type="checkbox"/> N
US Fish and Wildlife, Endangered Species Act Section 7 Biological Opinion	<input type="checkbox"/> Y	<input checked="" type="checkbox"/> N
Statewide Construction General Permit Coverage	<input checked="" type="checkbox"/> Y	<input type="checkbox"/> N
Statewide Industrial General Permit Coverage (dependent of tenant)	<input type="checkbox"/> Y	<input checked="" type="checkbox"/> N
Western Riverside MSHCP Consistency Approval (e.g., JPR, DBESP)	<input type="checkbox"/> Y	<input checked="" type="checkbox"/> N
Other <i>(please list in the space below as required)</i> County of Riverside – Grading Permit & Building Permit	<input checked="" type="checkbox"/> Y	<input type="checkbox"/> N

If yes is answered to any of the questions above, the Co-Permittee may require proof of approval/coverage from those agencies as applicable including documentation of any associated requirements that may affect this Project-Specific WQMP.

Section B: Optimize Site Utilization (LID Principles)

Review of the information collected in Section 'A' will aid in identifying the principal constraints on site design and selection of LID BMPs as well as opportunities to reduce imperviousness and incorporate LID Principles into the site and landscape design. For example, **constraints** might include impermeable soils, high groundwater, groundwater pollution or contaminated soils, steep slopes, geotechnical instability, high-intensity land use, heavy pedestrian or vehicular traffic, utility locations or safety concerns. **Opportunities** might include existing natural areas, low areas, oddly configured or otherwise unbuildable parcels, easements and landscape amenities including open space and buffers (which can double as locations for bioretention BMPs), and differences in elevation (which can provide hydraulic head). Prepare a brief narrative for each of the site optimization strategies described below. This narrative will help you as you proceed with your LID design and explain your design decisions to others.

The 2010 Santa Ana MS4 Permit further requires that LID Retention BMPs (Infiltration Only or Harvest and Use) be used unless it can be shown that those BMPs are infeasible. Therefore, it is important that your narrative identify and justify if there are any constraints that would prevent the use of those categories of LID BMPs. Similarly, you should also note opportunities that exist which will be utilized during project design. Upon completion of identifying Constraints and Opportunities, include these on your WQMP Site plan in Appendix 1.

Consideration of "highest and best use" of the discharge should also be considered. For example, Lake Elsinore is evaporating faster than runoff from natural precipitation can recharge it. Requiring infiltration of 85% of runoff events for projects tributary to Lake Elsinore would only exacerbate current water quality problems associated with Pollutant concentration due to lake water evaporation. In cases where rainfall events have low potential to recharge Lake Elsinore (i.e. no hydraulic connection between groundwater to Lake Elsinore, or other factors), requiring infiltration of Urban Runoff from projects is counterproductive to the overall watershed goals. Project proponents, in these cases, would be allowed to discharge Urban Runoff, provided they used equally effective filtration-based BMPs.

Site Optimization

The following questions are based upon Section 3.2 of the WQMP Guidance Document. Review of the WQMP Guidance Document will help you determine how best to optimize your site and subsequently identify opportunities and/or constraints, and document compliance.

Did you identify and preserve existing drainage patterns? If so, how? If not, why?

In terms of drainage, the existing site is divided in two. The northerly portion of the site drains in a northeasterly direction towards Cajalco Road cul-de-sac. The southerly portion of the site drains in a southeasterly direction. In the post-project condition, the drainage pattern will be maintained as similar to the pre-project condition.

Did you identify and protect existing vegetation? If so, how? If not, why?

The site has little vegetation on the southerly portion of the site. It appears that vegetation in the southerly portion has been consistently cleared over many years. On the other hand, the northerly portion consists of existing residential homes and parking/storage areas.

Did you identify and preserve natural infiltration capacity? If so, how? If not, why?

Where applicable, runoff from the proposed hardscape area are being directed towards landscape area in an effort to promote incidental infiltration and preserve the infiltration capacity. Site-specific infiltration tests were performed and results indicated rates specific to where the permanent BMPs are proposed have relatively poor infiltration rates. Additionally, runoff from the site will ultimately drain to Canyon Lake and Lake Elsinore (where “highest and best use” are considered). As a result, it was determined that infiltration BMPs were not suitable for the site and two bioretention facilities are proposed for this project.

Did you identify and minimize impervious area? If so, how? If not, why?

Impervious areas are only used where necessary and have been minimized to the extent practicable. Parking spaces are minimized close to the required amount and the landscaped areas have been maximized to the extent practicable.

Did you identify and disperse runoff to adjacent pervious areas? If so, how? If not, why?

Runoff from impervious surfaces is directed to the pervious areas where possible prior to being directed to the proposed structural BMP for water quality treatment.

Section C: Delineate Drainage Management Areas (DMAs)

Utilizing the procedure in Section 3.3 of the WQMP Guidance Document which discusses the methods of delineating and mapping your project site into individual DMAs, complete Table C.1 below to appropriately categorize the types of classification (e.g., Type A, Type B, etc.) per DMA for your project site. Upon completion of this table, this information will then be used to populate and tabulate the corresponding tables for their respective DMA classifications.

Table C.1 DMA Classifications

DMA Name or ID	Surface Type(s) ¹²	Area (Sq. Ft.)	DMA Type
DMA 1-1	Ornamental Landscape	41,756	Type D
DMA 1-2	Concrete or Asphalt	49,154	Type D
DMA 1-3	Roofs	296,877	Type D
DMA 2-1	Ornamental Landscape	48,132	Type D
DMA 2-2	Concrete or Asphalt	201,617	Type D
DMA 2-3	Roofs	48,778	Type D
DMA OFF1-1	Ornamental Landscape	28,450	Type B
DMA OFF1-2	Concrete or Asphalt	14,887	Type C
DMA OFF1-3	Decomposed Granite	3,068	Type B
DMA OFF2-1	Ornamental Landscape	5,801	Type B
DMA OFF2-2	Concrete or Asphalt	4,501	Type C
DMA OFF2-3	Decomposed Granite	2,727	Type B
DMA-Misc	Self-Treating Area	21,866	Type A

¹Reference Table 2-1 in the WQMP Guidance Document to populate this column

²If multi-surface provide back-up

Table C.2 Type 'A', Self-Treating Areas

DMA Name or ID	Area (Sq. Ft.)	Stabilization Type	Irrigation Type (if any)
DMA-Misc	21,866	Landscaping	Drip

Table C.3 Type 'B', Self-Retaining Areas

Self-Retaining Area				Type 'C' DMAs that are draining to the Self-Retaining Area		
DMA Name/ ID	Post-project surface type	Area (square feet)	Storm Depth (inches)	DMA Name / ID	[C] from Table C.4	Required Retention Depth (inches)
		[A]	[B]		[C]	

DMA OFF1-1 & DMA OFF1-3	Ornamental Landscape D.G.	28,450+3,068 = 31,518	0.58off	DMA OFF1-2 & DMA OFF1-3	14,487	0.85
DMA OFF2-1 & DMA OFF2-3	Ornamental Landscape D.G.	5,801+2,727 = 8,528	0.58	DMA OFF2-2 & DMA OFF2-3	4,501	0.89

$$[D] = [B] + \frac{[B] \cdot [C]}{[A]}$$

Table C.4 Type 'C', Areas that Drain to Self-Retaining Areas

DMA					Receiving Self-Retaining DMA		
DMA Name/ ID	Area (square feet)	Post-project surface type	Impervious fraction	Product	DMA name /ID	Area (square feet)	Ratio
	[A]					[B]	[C] = [A] x [B]
DMA OFF1-2	14,887	Asphalt	1.0	14,887	SRA OFF1	8,623	1.7
DMA OFF2-2	4,501	Asphalt	1.0	4,501	SRA OFF1	3,376	1.3

Table C.5 Type 'D', Areas Draining to BMPs

DMA Name or ID	BMP Name or ID
DMA 1-1	BMP 1-Bioretention Facility
DMA 1-2	BMP 1-Bioretention Facility
DMA 1-3	BMP 1-Bioretention Facility
DMA 2-1	BMP 2-Bioretention Facility
DMA 2-2	BMP 2-Bioretention Facility
DMA 2-3	BMP 2-Bioretention Facility

Note: More than one drainage management area can drain to a single LID BMP, however, one drainage management area may not drain to more than one BMP.

Section D: Implement LID BMPs

D.1 Infiltration Applicability

Is there an approved downstream ‘Highest and Best Use’ for stormwater runoff (see discussion in Chapter 2.4.4 of the WQMP Guidance Document for further details)? Y N

If yes has been checked, Infiltration BMPs shall not be used for the site; proceed to section D.3

If no, continue working through this section to implement your LID BMPs. It is recommended that you contact your Co-Permittee to verify whether or not your project discharges to an approved downstream ‘Highest and Best Use’ feature.

Geotechnical Report

A Geotechnical Report or Phase I Environmental Site Assessment may be required by the Copermitee to confirm present and past site characteristics that may affect the use of Infiltration BMPs. In addition, the Co-Permittee, at their discretion, may not require a geotechnical report for small projects as described in Chapter 2 of the WQMP Guidance Document. If a geotechnical report has been prepared, include it in Appendix 3. In addition, if a Phase I Environmental Site Assessment has been prepared, include it in Appendix 4.

Is this project classified as a small project consistent with the requirements of Chapter 2 of the WQMP Guidance Document? Y N

Infiltration Feasibility

Table D.1 below is meant to provide a simple means of assessing which DMAs on your site support Infiltration BMPs and is discussed in the WQMP Guidance Document in Chapter 2.4.5. Check the appropriate box for each question and then list affected DMAs as applicable. If additional space is needed, add a row below the corresponding answer.

Table D.1 Infiltration Feasibility

Does the project site...	YES	NO
...have any DMAs with a seasonal high groundwater mark shallower than 10 feet? If Yes, list affected DMAs:		✓
...have any DMAs located within 100 feet of a water supply well? If Yes, list affected DMAs:		✓
...have any areas identified by the geotechnical report as posing a public safety risk where infiltration of stormwater could have a negative impact? If Yes, list affected DMAs: DMA 1, DMA 2, DMA OFF1, DMA OFF2		✓
...have measured in-situ infiltration rates of less than 1.6 inches / hour? If Yes, list affected DMAs:	✓	
...have significant cut and/or fill conditions that would preclude in-situ testing of infiltration rates at the final infiltration surface? If Yes, list affected DMAs:		✓
...geotechnical report identify other site-specific factors that would preclude effective and safe infiltration? Describe here:		✓

If you answered “Yes” to any of the questions above for any DMA, Infiltration BMPs should not be used for those DMAs and you should proceed to the assessment for Harvest and Use below.

D.2 Harvest and Use Assessment

Please check what applies:

- Reclaimed water will be used for the non-potable water demands for the project.
- Downstream water rights may be impacted by Harvest and Use as approved by the Regional Board (verify with the Copermittee).
- The Design Capture Volume will be addressed using Infiltration Only BMPs. In such a case, Harvest and Use BMPs are still encouraged, but it would not be required if the Design Capture Volume will be infiltrated or evapotranspired.

If any of the above boxes have been checked, Harvest and Use BMPs need not be assessed for the site. If none of the above criteria applies, follow the steps below to assess the feasibility of irrigation use, toilet use and other non-potable uses (e.g., industrial use).

Irrigation Use Feasibility

Complete the following steps to determine the feasibility of harvesting stormwater runoff for Irrigation Use BMPs on your site:

- Step 1: Identify the total area of irrigated landscape on the site, and the type of landscaping used.
Total Area of Irrigated Landscape: Insert Area (Acres)
Type of Landscaping (Conservation Design or Active Turf): List Landscaping Type
- Step 2: Identify the planned total of all impervious areas on the proposed project from which runoff might be feasibly captured and stored for irrigation use. Depending on the configuration of buildings and other impervious areas on the site, you may consider the site as a whole, or parts of the site, to evaluate reasonable scenarios for capturing and storing runoff and directing the stored runoff to the potential use(s) identified in Step 1 above.
Total Area of Impervious Surfaces: Insert Area (Acres)
- Step 3: Cross reference the Design Storm depth for the project site (see Exhibit A of the WQMP Guidance Document) with the left column of Table 2-3 in Chapter 2 to determine the minimum area of Effective Irrigated Area per Tributary Impervious Area (EIATIA).
Enter your EIATIA factor: EIATIA Factor
- Step 4: Multiply the unit value obtained from Step 3 by the total of impervious areas from Step 2 to develop the minimum irrigated area that would be required.
Minimum required irrigated area: Insert Area (Acres)
- Step 5: Determine if harvesting stormwater runoff for irrigation use is feasible for the project by comparing the total area of irrigated landscape (Step 1) to the minimum required irrigated area (Step 4).

Minimum required irrigated area (Step 4)	Available Irrigated Landscape (Step 1)
Insert Area (Acres)	Insert Area (Acres)

Toilet Use Feasibility

Complete the following steps to determine the feasibility of harvesting stormwater runoff for toilet flushing uses on your site:

Step 1: Identify the projected total number of daily toilet users during the wet season, and account for any periodic shut downs or other lapses in occupancy:

Projected Number of Daily Toilet Users: Number of daily Toilet Users

Project Type: Enter 'Residential', 'Commercial', 'Industrial' or 'Schools'

Step 2: Identify the planned total of all impervious areas on the proposed project from which runoff might be feasibly captured and stored for toilet use. Depending on the configuration of buildings and other impervious areas on the site, you may consider the site as a whole, or parts of the site, to evaluate reasonable scenarios for capturing and storing runoff and directing the stored runoff to the potential use(s) identified in Step 1 above.

Total Area of Impervious Surfaces: Insert Area (Acres)

Step 3: Enter the Design Storm depth for the project site (see Exhibit A) into the left column of Table 2-2 in Chapter 2 to determine the minimum number or toilet users per tributary impervious acre (TUTIA).

Enter your TUTIA factor: TUTIA Factor

Step 4: Multiply the unit value obtained from Step 3 by the total of impervious areas from Step 2 to develop the minimum number of toilet users that would be required.

Minimum number of toilet users: Required number of toilet users

Step 5: Determine if harvesting stormwater runoff for toilet flushing use is feasible for the project by comparing the Number of Daily Toilet Users (Step 1) to the minimum required number of toilet users (Step 4).

Minimum required Toilet Users (Step 4)	Projected number of toilet users (Step 1)
Insert Area (Acres)	Insert Area (Acres)

Other Non-Potable Use Feasibility

Are there other non-potable uses for stormwater runoff on the site (e.g. industrial use)? See Chapter 2 of the Guidance for further information. If yes, describe below. If no, write N/A.

Insert narrative description here.

Step 1: Identify the projected average daily non-potable demand, in gallons per day, during the wet season and accounting for any periodic shut downs or other lapses in occupancy or operation.

Average Daily Demand: Projected Average Daily Use (gpd)

Step 2: Identify the planned total of all impervious areas on the proposed project from which runoff might be feasibly captured and stored for the identified non-potable use. Depending on the configuration of buildings and other impervious areas on the site, you may consider the site as a whole, or parts of the site, to evaluate reasonable scenarios for capturing and storing runoff and directing the stored runoff to the potential use(s) identified in Step 1 above.

Total Area of Impervious Surfaces: Insert Area (Acres)

Step 3: Enter the Design Storm depth for the project site (see Exhibit A) into the left column of Table 2-4 in Chapter 2 to determine the minimum demand for non-potable uses per tributary impervious acre.

Enter the factor from Table 2-4: Enter Value

Step 4: Multiply the unit value obtained from Step 3 by the total of impervious areas from Step 2 to develop the minimum number of gallons per day of non-potable use that would be required.

Minimum required use: Minimum use required (gpd)

Step 5: Determine if harvesting stormwater runoff for other non-potable use is feasible for the project by comparing the projected average daily use (Step 1) to the minimum required non-potable use (Step 4).

Minimum required non-potable use (Step 4)	Projected average daily use (Step 1)
Minimum use required (gpd)	Projected Average Daily Use (gpd)

If Irrigation, Toilet and Other Use feasibility anticipated demands are less than the applicable minimum values, Harvest and Use BMPs are not required and you should proceed to utilize LID Bioretention and Biotreatment per Section 3.4.2 of the WQMP Guidance Document.

D.3 Bioretention and Biotreatment Assessment

Other LID Bioretention and Biotreatment BMPs as described in Chapter 2.4.7 of the WQMP Guidance Document are feasible on nearly all development sites with sufficient advance planning.

Select one of the following:

- LID Bioretention/Biotreatment BMPs will be used for some or all DMAs of the project as noted below in Section D.4 (note the requirements of Section 3.4.2 in the WQMP Guidance Document).
- A site-specific analysis demonstrating the technical infeasibility of all LID BMPs has been performed and is included in Appendix 5. If you plan to submit an analysis demonstrating the technical infeasibility of LID BMPs, request a pre-submittal meeting with the Copermittee to discuss this option. Proceed to Section E to document your alternative compliance measures.

D.4 Feasibility Assessment Summaries

From the Infiltration, Harvest and Use, Bioretention and Biotreatment Sections above, complete Table D.2 below to summarize which LID BMPs are technically feasible, and which are not, based upon the established hierarchy.

Table D.2 LID Prioritization Summary Matrix

DMA Name/ID	LID BMP Hierarchy				No LID (Alternative Compliance)
	1. Infiltration	2. Harvest and use	3. Bioretention	4. Biotreatment	
DMA 1-1	<input type="checkbox"/>	<input type="checkbox"/>	<input checked="" type="checkbox"/>	<input type="checkbox"/>	<input type="checkbox"/>
DMA 1-2	<input type="checkbox"/>	<input type="checkbox"/>	<input checked="" type="checkbox"/>	<input type="checkbox"/>	<input type="checkbox"/>
DMA 1-3	<input type="checkbox"/>	<input type="checkbox"/>	<input checked="" type="checkbox"/>	<input type="checkbox"/>	<input type="checkbox"/>
DMA 2-1	<input type="checkbox"/>	<input type="checkbox"/>	<input checked="" type="checkbox"/>	<input type="checkbox"/>	<input type="checkbox"/>
DMA 2-2	<input type="checkbox"/>	<input type="checkbox"/>	<input checked="" type="checkbox"/>	<input type="checkbox"/>	<input type="checkbox"/>
DMA 2-3	<input type="checkbox"/>	<input type="checkbox"/>	<input checked="" type="checkbox"/>	<input type="checkbox"/>	<input type="checkbox"/>

For those DMAs where LID BMPs are not feasible, provide a brief narrative below summarizing why they are not feasible, include your technical infeasibility criteria in Appendix 5, and proceed to Section E below to document Alternative Compliance measures for those DMAs. Recall that each proposed DMA must pass through the LID BMP hierarchy before alternative compliance measures may be considered.

N/A

D.5 LID BMP Sizing

Each LID BMP must be designed to ensure that the Design Capture Volume will be addressed by the selected BMPs. First, calculate the Design Capture Volume for each LID BMP using the V_{BMP} worksheet in Appendix F of the LID BMP Design Handbook. Second, design the LID BMP to meet the required V_{BMP} using a method approved by the Copermittee. Utilize the worksheets found in the LID BMP Design Handbook or consult with your Copermittee to assist you in correctly sizing your LID BMPs. Complete Table D.3 below to document the Design Capture Volume and the Proposed Volume for each LID BMP. Provide the completed design procedure sheets for each LID BMP in Appendix 6. You may add additional rows to the table below as needed.

Table D.3 DCV Calculations for LID BMPs

DMA Type/ID	DMA Area (square feet)	Post-Project Surface Type	Effective Impervious Fraction, I_f	DMA Runoff Factor	DMA Areas x Runoff Factor	"BMP 1" / Bioretention Facility		
						Design Storm Depth (in)	Design Capture Volume, V_{BMP} (cubic feet)	Proposed Volume on Plans (cubic feet)
	[A]		[B]	[C]	[A] x [C]			
DMA 1-1	41,756	Ornamental Landscaping	0.1	0.11	4612.3			
DMA 1-2	49,154	Concrete or Asphalt	1.0	0.89	43845.4			
DMA 1-3	296,877	Roofs	1.0	0.89	264814.3			
	$A_T = \Sigma[A] = 387,787$				$\Sigma = [D] = 313,272$	$[E] = 0.58$	$[F] = \frac{[D] \times [E]}{12} = 15,141.5$	$[G] = 16,543$

[B], [C] is obtained as described in Section 2.3.1 of the WQMP Guidance Document.

[E] is obtained from Section 2.3.1 in the WQMP Guidance Document.

[G] is obtained from the proprietary BMP manufacturer (BioClean A Forterra Company).

Table D.4 DCV Calculations for LID BMPs

DMA Type/ID	DMA Area (square feet)	Post-Project Surface Type	Effective Impervious Fraction, I_f	DMA Runoff Factor	DMA Areas x Runoff Factor	"BMP 2" / Bioretention Facility		
	[A]		[B]	[C]	[A] x [C]			
DMA 2-1	48,132	<i>Ornamental Landscaping</i>	0.1	0.11	5316.6	<i>Design Storm Depth (in)</i>	<i>Design Capture Volume, V_{BMP} (cubic feet)</i>	<i>Proposed Volume on Plans (cubic feet)</i>
DMA 2-2	201,617	<i>Concrete or Asphalt</i>	1.0	0.89	179842.4			
DMA 2-3	48,778	<i>Roofs</i>	1.0	0.89	43510			
	$A_T =$ $\Sigma[A] =$ 298,527				$\Sigma = [D] =$ 228669	$[E] =$ 0.58	$[F] =$ $\frac{[D] \times [E]}{12} =$ 11,052.3	$[G] =$ 15,048

[B], [C] is obtained as described in Section 2.3.1 of the WQMP Guidance Document.

[E] is obtained from Section 2.3.1 in the WQMP Guidance Document.

[G] is obtained from the proprietary BMP manufacturer (BioClean A Forterra Company).

Section E: Alternative Compliance (LID Waiver Program)

LID BMPs are expected to be feasible on virtually all projects. Where LID BMPs have been demonstrated to be infeasible as documented in Section D, other Treatment Control BMPs must be used (subject to LID waiver approval by the Copermittee). Check one of the following Boxes:

LID Principles and LID BMPs have been incorporated into the site design to fully address all Drainage Management Areas. **No alternative compliance measures are required for this project and thus this Section is not required to be completed.**

- Or -

The following Drainage Management Areas are unable to be addressed using LID BMPs. A site-specific analysis demonstrating technical infeasibility of LID BMPs has been approved by the Co-Permittee and included in Appendix 5. Additionally, no downstream regional and/or sub-regional LID BMPs exist or are available for use by the project. The following alternative compliance measures on the following pages are being implemented to ensure that any pollutant loads expected to be discharged by not incorporating LID BMPs, are fully mitigated.

N/A

E.1 Identify Pollutants of Concern

Utilizing Table A.1 from Section A above which noted your project's receiving waters and their associated EPA approved 303(d) listed impairments, cross reference this information with that of your selected Priority Development Project Category in Table E.1 below. If the identified General Pollutant Categories are the same as those listed for your receiving waters, then these will be your Pollutants of Concern and the appropriate box or boxes will be checked on the last row. The purpose of this is to document compliance and to help you appropriately plan for mitigating your Pollutants of Concern in lieu of implementing LID BMPs.

Table E.1 Potential Pollutants by Land Use Type

Priority Development Project Categories and/or Project Features (check those that apply)	General Pollutant Categories							
	Bacterial Indicators	Metals	Nutrients	Pesticides	Toxic Organic Compounds	Sediments	Trash & Debris	Oil & Grease
<input type="checkbox"/> Detached Residential Development	P	N	P	P	N	P	P	P
<input type="checkbox"/> Attached Residential Development	P	N	P	P	N	P	P	P ⁽²⁾
<input type="checkbox"/> Commercial/Industrial Development	P ⁽³⁾	P	P ⁽¹⁾	P ⁽¹⁾	P ⁽⁵⁾	P ⁽¹⁾	P	P
<input type="checkbox"/> Automotive Repair Shops	N	P	N	N	P ^(4, 5)	N	P	P
<input type="checkbox"/> Restaurants (>5,000 ft ²)	P	N	N	N	N	N	P	P
<input type="checkbox"/> Hillside Development (>5,000 ft ²)	P	N	P	P	N	P	P	P
<input type="checkbox"/> Parking Lots (>5,000 ft ²)	P ⁽⁶⁾	P	P ⁽¹⁾	P ⁽¹⁾	P ⁽⁴⁾	P ⁽¹⁾	P	P
<input type="checkbox"/> Retail Gasoline Outlets	N	P	N	N	P	N	P	P
Project Priority Pollutant(s) of Concern	<input type="checkbox"/>	<input type="checkbox"/>	<input type="checkbox"/>	<input type="checkbox"/>	<input type="checkbox"/>	<input type="checkbox"/>	<input type="checkbox"/>	<input type="checkbox"/>

P = Potential

N = Not Potential

⁽¹⁾ A potential Pollutant if non-native landscaping exists or is proposed onsite; otherwise not expected

⁽²⁾ A potential Pollutant if the project includes uncovered parking areas; otherwise not expected

⁽³⁾ A potential Pollutant is land use involving animal waste

⁽⁴⁾ Specifically petroleum hydrocarbons

⁽⁵⁾ Specifically solvents

⁽⁶⁾ Bacterial indicators are routinely detected in pavement runoff

E.2 Stormwater Credits

Projects that cannot implement LID BMPs but nevertheless implement smart growth principles are potentially eligible for Stormwater Credits. Utilize Table 3-8 within the WQMP Guidance Document to identify your Project Category and its associated Water Quality Credit. If not applicable, write N/A.

Table E.2 Water Quality Credits

Qualifying Project Categories	Credit Percentage ²
<i>Total Credit Percentage¹</i>	

¹Cannot Exceed 50%

²Obtain corresponding data from Table 3-8 in the WQMP Guidance Document

E.3 Sizing Criteria

After you appropriately considered Stormwater Credits for your project, utilize Table E.3 below to appropriately size them to the DCV, or Design Flow Rate, as applicable. Please reference Chapter 3.5.2 of the WQMP Guidance Document for further information.

Table E.3 Treatment Control BMP Sizing

DMA Type/ID	DMA Area (square feet)	Post-Project Surface Type	Effective Impervious Fraction, I _f	DMA Runoff Factor	DMA Area x Runoff Factor	Enter BMP Name / Identifier Here			
	[A]		[B]	[C]	[A] x [C]				
						<i>Design Storm Depth (in)</i> <i>Minimum Design Capture Volume or Design Flow Rate (cubic feet or cfs)</i> <i>Total Storm Water Credit % Reduction</i> <i>Proposed Volume or Flow on Plans (cubic feet or cfs)</i>			
	$A_T = \sum[A]$				$\sum = [D]$	[E]	$[F] = \frac{[D] \times [E]}{[G]}$	$[F] \times (1-[H])$	[I]

[B], [C] is obtained as described in Section 2.3.1 from the WQMP Guidance Document

[E] is for Flow-Based Treatment Control BMPs [E] = .2, for Volume-Based Control Treatment BMPs, [E] obtained from Exhibit A in the WQMP Guidance Document

[G] is for Flow-Based Treatment Control BMPs [G] = 43,560, for Volume-Based Control Treatment BMPs, [G] = 12

[H] is from the Total Credit Percentage as Calculated from Table E.2 above

[I] as obtained from a design procedure sheet from the BMP manufacturer and should be included in Appendix 6

E.4 Treatment Control BMP Selection

Treatment Control BMPs typically provide proprietary treatment mechanisms to treat potential pollutants in runoff, but do not sustain significant biological processes. Treatment Control BMPs must have a removal efficiency of a medium or high effectiveness as quantified below:

- **High:** equal to or greater than 80% removal efficiency
- **Medium:** between 40% and 80% removal efficiency

Such removal efficiency documentation (e.g., studies, reports, etc.) as further discussed in Chapter 3.5.2 of the WQMP Guidance Document, must be included in Appendix 6. In addition, ensure that proposed Treatment Control BMPs are properly identified on the WQMP Site Plan in Appendix 1.

Table E.4 Treatment Control BMP Selection

Selected Treatment Control BMP Name or ID ¹	Priority Pollutant(s) of Concern to Mitigate ²	Removal Percentage ³	Efficiency

¹ Treatment Control BMPs must not be constructed within Receiving Waters. In addition, a proposed Treatment Control BMP may be listed more than once if they possess more than one qualifying pollutant removal efficiency.

² Cross Reference Table E.1 above to populate this column.

³ As documented in a Co-Permittee Approved Study and provided in Appendix 6.

Section F: Hydromodification

F.1 Hydrologic Conditions of Concern (HCOC) Analysis

Once you have determined that the LID design is adequate to address water quality requirements, you will need to assess if the proposed LID Design may still create a HCOC. Review Chapters 2 and 3 (including Figure 3-7) of the WQMP Guidance Document to determine if your project must mitigate for Hydromodification impacts. If your project meets one of the following criteria which will be indicated by the check boxes below, you do not need to address Hydromodification at this time. However, if the project does not qualify for Exemptions 1, 2 or 3, then additional measures must be added to the design to comply with HCOC criteria. This is discussed in further detail below in Section F.2.

HCOC EXEMPTION 1: The Priority Development Project disturbs less than one acre. The Copermitttee has the discretion to require a Project-Specific WQMP to address HCOCs on projects less than one acre on a case by case basis. The disturbed area calculation should include all disturbances associated with larger common plans of development.

Does the project qualify for this HCOC Exemption? Y N

If Yes, HCOC criteria do not apply.

HCOC EXEMPTION 2: The volume and time of concentration¹ of storm water runoff for the post-development condition is not significantly different from the pre-development condition for a 2-year return frequency storm (a difference of 5% or less is considered insignificant) using one of the following methods to calculate:

- Riverside County Hydrology Manual
- Technical Release 55 (TR-55): Urban Hydrology for Small Watersheds (NRCS 1986), or derivatives thereof, such as the Santa Barbara Urban Hydrograph Method
- Other methods acceptable to the Co-Permittee

Does the project qualify for this HCOC Exemption? Y N

If Yes, report results in Table F.1 below and provide your substantiated hydrologic analysis in Appendix 7.

Table F.1 Hydrologic Conditions of Concern Summary

	2 year – 24 hour		
	Pre-condition	Post-condition	% Difference
Time of Concentration	INSERT VALUE	INSERT VALUE	INSERT VALUE
Volume (Cubic Feet)	INSERT VALUE	INSERT VALUE	INSERT VALUE

¹ Time of concentration is defined as the time after the beginning of the rainfall when all portions of the drainage basin are contributing to flow at the outlet.

HCOC EXEMPTION 3: All downstream conveyance channels to an adequate sump (for example, Prado Dam, Lake Elsinore, Canyon Lake, Santa Ana River, or other lake, reservoir or naturally erosion resistant feature) that will receive runoff from the project are engineered and regularly maintained to ensure design flow capacity; no sensitive stream habitat areas will be adversely affected; or are not identified on the Co-Permittees Hydromodification Susceptibility Maps.

Does the project qualify for this HCOC Exemption? Y N

If Yes, HCOC criteria do not apply and note below which adequate sump applies to this HCOC qualifier:

F.2 HCOC Mitigation

If none of the above HCOC Exemption Criteria are applicable, HCOC criteria is considered mitigated if they meet one of the following conditions:

- a. Additional LID BMPS are implemented onsite or offsite to mitigate potential erosion or habitat impacts as a result of HCOCs. This can be conducted by an evaluation of site-specific conditions utilizing accepted professional methodologies published by entities such as the California Stormwater Quality Association (CASQA), the Southern California Coastal Water Research Project (SCCRWP), or other Co-Permittee approved methodologies for site-specific HCOC analysis.
- b. The project is developed consistent with an approved Watershed Action Plan that addresses HCOC in Receiving Waters.
- c. Mimicking the pre-development hydrograph with the post-development hydrograph, for a 2-year return frequency storm. Generally, the hydrologic conditions of concern are not significant, if the post-development hydrograph is no more than 10% greater than pre-development hydrograph. In cases where excess volume cannot be infiltrated or captured and reused, discharge from the site must be limited to a flow rate no greater than 110% of the pre-development 2-year peak flow.

Be sure to include all pertinent documentation used in your analysis of the items a, b or c in Appendix 7.

Note: The project is within the Riverside County WAP HCOC Exemption area approved on April 20, 2017. Therefore, the project should be exempt from the HCOC requirements.

Section G: Source Control BMPs

Source control BMPs include permanent, structural features that may be required in your project plans — such as roofs over and berms around trash and recycling areas — and Operational BMPs, such as regular sweeping and “housekeeping”, that must be implemented by the site’s occupant or user. The MEP standard typically requires both types of BMPs. In general, Operational BMPs cannot be substituted for a feasible and effective permanent BMP. Using the Pollutant Sources/Source Control Checklist in Appendix 8, review the following procedure to specify Source Control BMPs for your site:

1. **Identify Pollutant Sources:** Review Column 1 in the Pollutant Sources/Source Control Checklist. Check off the potential sources of Pollutants that apply to your site.
2. **Note Locations on Project-Specific WQMP Exhibit:** Note the corresponding requirements listed in Column 2 of the Pollutant Sources/Source Control Checklist. Show the location of each Pollutant source and each permanent Source Control BMP in your Project-Specific WQMP Exhibit located in Appendix 1.
3. **Prepare a Table and Narrative:** Check off the corresponding requirements listed in Column 3 in the Pollutant Sources/Source Control Checklist. In the left column of Table G.1 below, list each potential source of runoff Pollutants on your site (from those that you checked in the Pollutant Sources/Source Control Checklist). In the middle column, list the corresponding permanent, Structural Source Control BMPs (from Columns 2 and 3 of the Pollutant Sources/Source Control Checklist) used to prevent Pollutants from entering runoff. **Add additional narrative** in this column that explains any special features, materials or methods of construction that will be used to implement these permanent, Structural Source Control BMPs.
4. **Identify Operational Source Control BMPs:** To complete your table, refer once again to the Pollutant Sources/Source Control Checklist. List in the right column of your table the Operational BMPs that should be implemented as long as the anticipated activities continue at the site. Copermittee stormwater ordinances require that applicable Source Control BMPs be implemented; the same BMPs may also be required as a condition of a use permit or other revocable Discretionary Approval for use of the site.

Table G.1 Permanent and Operational Source Control Measures

Potential Sources of Runoff pollutants	Permanent Structural Source Control BMPs	Operational Source Control BMPs
On-site storm drain inlets	Mark all inlets with the words “Only Rain Down the Storm Drain” or similar. Catch Basin Markers may be available from the Riverside County Flood Control and Water Conservation District, call 951.955.1200 to verify.	Maintain and periodically repaint or replace inlet markings. Provide stormwater pollution prevention information to new site owners, lessees, or operators. ³ See applicable operational BMPs in Fact Sheet SC-44, “Drainage System Maintenance,” in the CASQA Stormwater Quality Handbooks at www.cabmphandbooks.com Include the following in lease agreements: “Tenant shall not allow anyone to discharge anything to storm drains or to store or deposit materials so as to create a potential discharge to

		storm drain.”
Interior floor drains	Interior floor drains shall be plumbed to sanitary sewer.	Inspect and maintain drains to prevent blockages and overflow.
Need for future indoor & structural pest control	Building design features including sealants barriers and fully closing windows and doors have been included to discourage entry of pests.	Integrated Pest Management (IPM) information to be provided to owners, lessees, and operators.
Landscape/outdoor pesticide use	Final Landscape Plans will accomplish the following: Preserve existing native trees, shrubs, and ground cover to the maximum extent possible. Design landscaping to minimize irrigation and runoff, to promote surface infiltration where appropriate, and to minimize the use of fertilizers and pesticides that can contribute to stormwater pollution. Where landscaped areas are used to retain or detain stormwater, specify plants that are tolerant of saturated soil conditions. Consider using pest-resistant plants, especially adjacent to hardscape. To insure successful establishment, select plants appropriate to site soils, slopes, climate, sun, wind, rain, land use, air movement, ecological consistency, and plant interactions.	Maintain landscaping using minimum or no pesticides. Prevent erosion of slopes by planting fast-growing, dense ground covering plants. Plant native vegetation to reduce the amount of water, fertilizers, and pesticides applied to the landscape. Do not overwater. Use irrigation practices such as drip irrigation, soaker hoses or micro-spray systems. Periodically inspect and fix leaks and misdirected sprinklers. Do not rake or blow leaves, clippings, or pruning waste into the street, gutter, or storm drain. Instead, dispose of green waste by composting, hauling it to a permitted landfill, or recycling it through your city’s program. Integrated Pest Management (IPM) information to be provided to owners, lessees, and operators.
Refuse areas	Site design features dumpster enclosures. Signs will be posted on or near dumpsters with the words “Do not dump hazardous materials here” or similar.	Periodic inspections for leaky, overfilled, uncovered, or other problematic conditions will occur. Corrective action will be made upon detection, as circumstances permit. Dumping of liquid or hazardous wastes will be prohibited. Spill control materials will be available on-site. All wastes to properly stored and disposed of in accordance with all applicable Local, State and Federal regulations
Industrial Processes	All process activities to be performed indoors. No processes to drain to exterior or to storm drain system.	All process activities to be performed indoors. No processes to drain to exterior or to storm drain system. See Fact Sheet SC-10, “Non-Stormwater Discharges” in the CASQA Stormwater Quality Handbooks at www.cabmphandbooks.com See the brochure “Industrial & Commercial Facilities Best Management Practices for: Industrial, Commercial Facilities” at http://rcflood.org/stormwater/
Fire Sprinkler Test Water	Provide a means to drain fire sprinkler test water to the sanitary sewer.	See the note in the Fact Sheet SC-41, “Building and Grounds Maintenance,” in the CASQA Stormwater Quality Handbooks at www.cabmphandbooks.com
Miscellaneous Drain or Wash Water or	Boiler drain lines shall be directly or	Inspect periodically to verify that

Other Sources	<p>indirectly connected to the sanitary sewer system and may not discharge to the storm drain system.</p> <p>Condensate drain lines may discharge to landscaped areas if the flow is small enough that runoff will not occur. Condensate drain lines may not discharge to the storm drain.</p> <p>Rooftop equipment with potential to produce pollutants shall be roofed and/or have secondary.</p> <p>Any drainage sumps on-site shall feature a sediment sump to reduce pumped water.</p> <p>Roofing, gutters, and trim made out of unprotected metals that may leach into runoff shall be avoided.</p>	equipment is not leaking or discharging to the storm drain system.
Plazas, Sidewalks, and Parking Lots	Maintain in a clean and orderly fashion.	Sweep plazas, sidewalks, and parking lots regularly to prevent accumulation of litter and debris. Collect debris from pressure washing to prevent entry into the storm drain system. Collect wash water containing any cleaning agent or degreaser and discharge to the sanitary sewer, not to a storm drain.

Section H: Construction Plan Checklist

Populate Table H.1 below to assist the plan checker in an expeditious review of your project. The first two columns will contain information that was prepared in previous steps, while the last column will be populated with the corresponding plan sheets. This table is to be completed with the submittal of your final Project-Specific WQMP.

Table H.1 Construction Plan Cross-reference

BMP No. or ID	BMP Identifier and Description	Corresponding Plan Sheet(s)	BMP Location (Lat/Long)
BMP 1	Bioretention Facility (BMP 1)	BMP Site Plan	33°50'13.45"N / 117°15'34.29"W
BMP 2	Bioretention Facility (BMP 2)	BMP Site Plan	33°50'3.35"N / 117°15'34.29"W

Note that the updated table — or Construction Plan WQMP Checklist — is **only a reference tool** to facilitate an easy comparison of the construction plans to your Project-Specific WQMP. Co-Permittee staff can advise you regarding the process required to propose changes to the approved Project-Specific WQMP.

Section I: Operation, Maintenance and Funding

The Copermittee will periodically verify that Stormwater BMPs on your site are maintained and continue to operate as designed. To make this possible, your Copermittee will require that you include in Appendix 9 of this Project-Specific WQMP:

1. A means to finance and implement facility maintenance in perpetuity, including replacement cost.
2. Acceptance of responsibility for maintenance from the time the BMPs are constructed until responsibility for operation and maintenance is legally transferred. A warranty covering a period following construction may also be required.
3. An outline of general maintenance requirements for the Stormwater BMPs you have selected.
4. Figures delineating and designating pervious and impervious areas, location, and type of Stormwater BMP, and tables of pervious and impervious areas served by each facility. Geo-locating the BMPs using a coordinate system of latitude and longitude is recommended to help facilitate a future statewide database system.
5. A separate list and location of self-retaining areas or areas addressed by LID Principles that do not require specialized O&M or inspections but will require typical landscape maintenance as noted in Chapter 5, pages 85-86, in the WQMP Guidance. Include a brief description of typical landscape maintenance for these areas.

Your local Co-Permittee will also require that you prepare and submit a detailed Stormwater BMP Operation and Maintenance Plan that sets forth a maintenance schedule for each of the Stormwater BMPs built on your site. An agreement assigning responsibility for maintenance and providing for inspections and certification may also be required.

Details of these requirements and instructions for preparing a Stormwater BMP Operation and Maintenance Plan are in Chapter 5 of the WQMP Guidance Document.

Maintenance Mechanism: See Appendix 9

Will the proposed BMPs be maintained by a Home Owners' Association (HOA) or Property Owners Association (POA)?

Y N

Include your Operation and Maintenance Plan and Maintenance Mechanism in Appendix 9. Additionally, include all pertinent forms of educational materials for those personnel that will be maintaining the proposed BMPs within this Project-Specific WQMP in Appendix 10.

Note: To be completed at the time of the FWQMP.

Appendix 1: Maps and Site Plans

Location Map, WQMP Site Plan and Receiving Waters Map

Vicinity Map

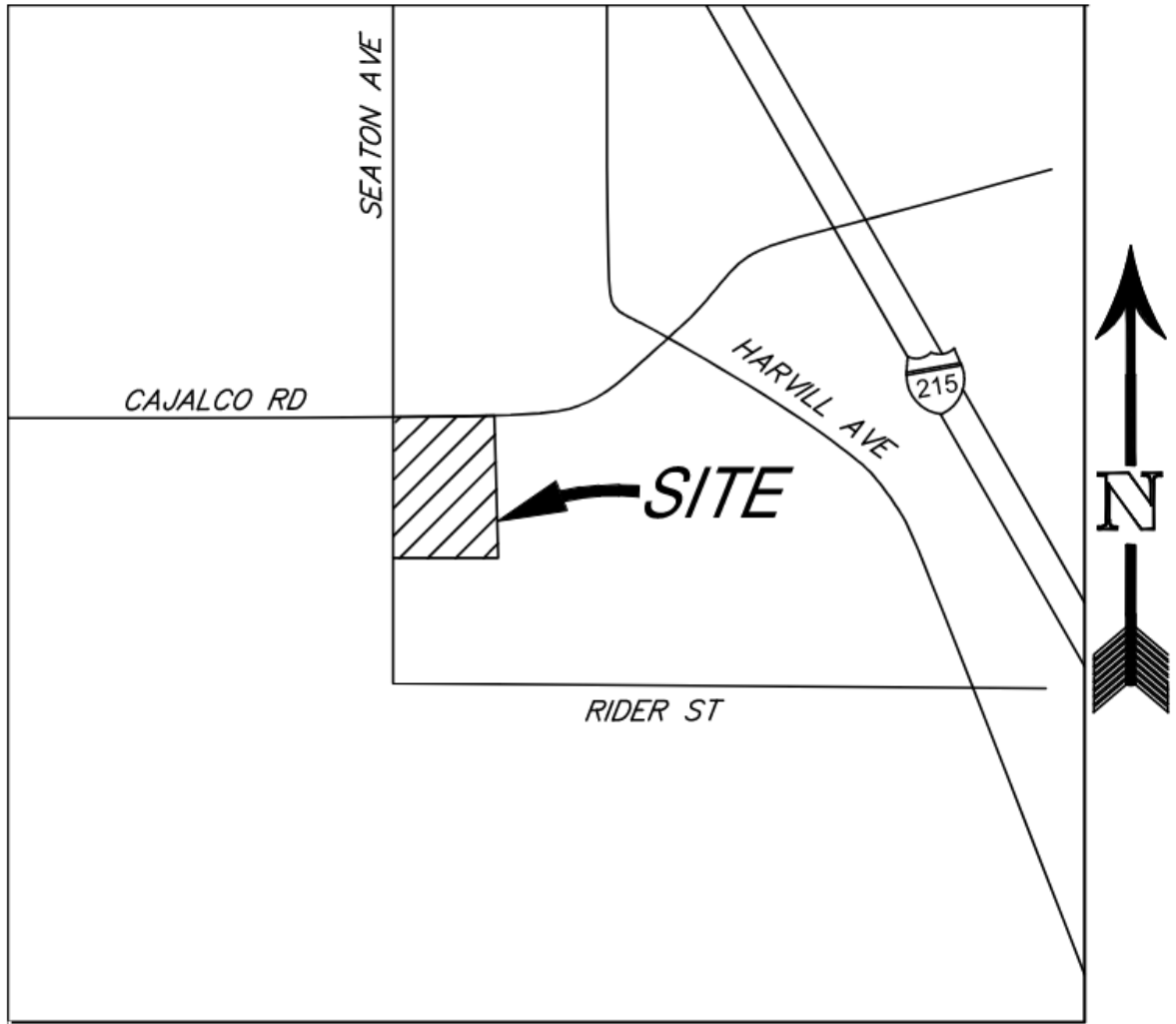

VICINITY MAP
NOT TO SCALE

The project is located at the southeast corner of the intersection of Cajalco Expressway and Seaton Avenue in the unincorporated Riverside County, CA.

**EXCERPT - RECEIVING WATER MAP
(SUPPLEMENTAL)**

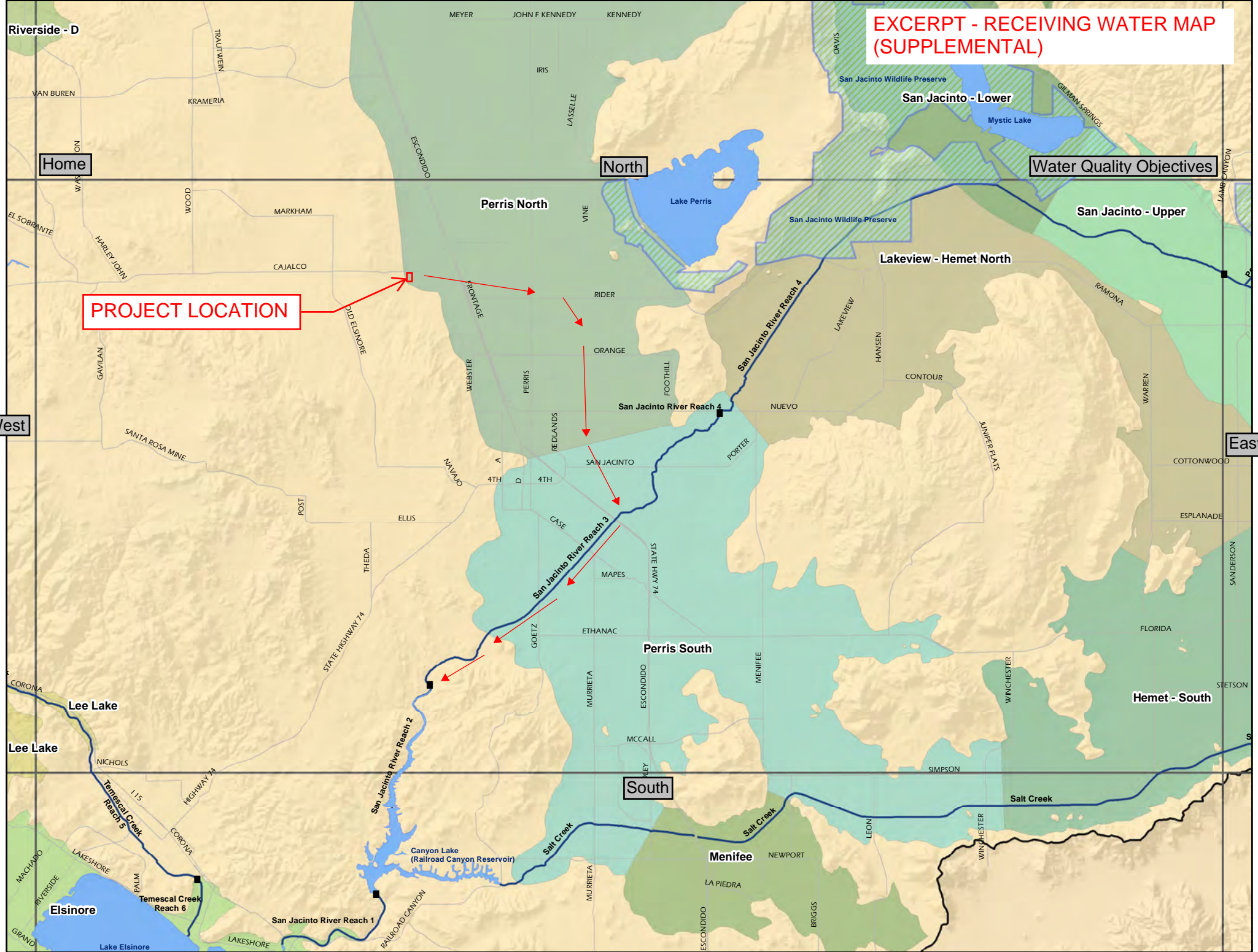

PROJECT LOCATION

Water Quality Objectives

Home

North

Perris North

San Jacinto - Lower

San Jacinto - Upper

Lakeview - Hemet North

West

East

San Jacinto River Reach 3

Perris South

Hemet - South

South

Menifee

Elsinore

San Jacinto River Reach 1

Salt Creek

GENERAL NOTES

1. NO OFFSITE RUN-ON IS EXPECTED. HOWEVER, AS PART OF THE PROJECT, PORTIONS OF FRONTAGE STREETS, INCLUDING SEATON AVENUE AND CAJALCO EXPRESSWAY, WILL BE IMPROVED. AT THIS TIME, THE STORM WATER QUALITY LOW-FLOWS FROM THE FRONTAGE STREET IMPROVEMENT PORTIONS WILL BE DIRECTED VIA CURB CUT OPENINGS TOWARDS THE PROPOSED SELF-RETAINING AREAS WITHIN PORTIONS OF THE PROPOSED PARKWAYS FOR TREATMENT PURPOSES. THE LARGER FLOWS GREATER THAN THE LOW-FLOW STORMS ARE EXPECTED TO BE BYPASSED AS SIMILAR TO THE EXISTING CONDITION.
2. BASED ON THE WEB SOIL SURVEY (ONLINE RESOURCE), THE PROJECT CONSISTS OF HYDROLOGIC SOIL GROUPS A, B, AND C WITH THE MAJORITY BEING THE SOIL GROUP C. BASED ON THE SITE-SPECIFIC INFILTRATION TESTING BY THE GEOTECHNICAL ENGINEER, THERE WAS ONE RATE AT THE SOUTHEASTERLY CORNER OF THE PROJECT WITH RELATIVELY LOW FIELD INFILTRATION RATE OF 0.2 INCH/HOUR, WHICH IS BELOW THE INFILTRATION FEASIBILITY THRESHOLD RATE OF 1.6 IN/HR. WHILE A FEW OTHER RATES WERE HIGHER, THE TESTING WAS CONDUCTED AT SHALLOWER DEPTHS. BASED ON THE INFORMATION PROVIDED, IT WAS DETERMINED THAT THE INFILTRATION IS NOT SUITABLE AND THEREFORE, BIORETENTION FACILITIES ARE PROPOSED FOR THIS PROJECT.
3. THE PROJECT IS SITUATED WITHIN THE FEMA ZONE X; THEREFORE, PROCESSING THROUGH FEMA IS NOT EXPECTED TO BE REQUIRED FOR THIS PROJECT.
4. PRELIMINARY DETAILS FOR TRASH ENCLOSURE WITH COVER AND CATCH BASIN STENCIL ARE PROVIDED ON THIS EXHIBIT; HOWEVER, THOSE DETAILS ALONG WITH ROOF DRAIN DETAILS ARE EXPECTED BE REFINED FURTHER AT THE TIME OF FINAL WOMP.

PERMANENT SOURCE CONTROL BMPs

1. MARK ALL INLETS WITH THE WORDS "ONLY RAIN DOWN THE STORM DRAIN" OR SIMILAR
2. ENCLOSED REFUSE AREA WITH SIGNS POSTED NEARBY STATING "DO NOT DUMP HAZARDOUS MATERIALS HERE" OR SIMILAR
 - LANDSCAPING DESIGNED TO MINIMIZE IRRIGATION AND RUNOFF, TO PROMOTE SURFACE INFILTRATION WHERE APPROPRIATE, AND TO MINIMIZE THE USE OF FERTILIZERS AND PESTICIDES THAT CAN CONTRIBUTE TO STORMWATER POLLUTION.

OPERATIONAL SOURCE CONTROL BMPs

- MAINTAIN LANDSCAPING USING MINIMUM OR NO PESTICIDES
- PREVENT EROSION OF SLOPES BY PLANTING FAST-GROWING, DENSE GROUND COVERING PLANTS
- PLANT NATIVE VEGETATION TO REDUCE THE AMOUNT OF WATER, FERTILIZERS, AND PESTICIDES APPLIED TO THE LANDSCAPE
- DO NOT OVERWATER
- USE IRRIGATION PRACTICES SUCH AS DRIP IRRIGATION, SOAKER HOSES OR MICRO-SPRAY SYSTEMS
- PERIODICALLY INSPECT AND FIX LEAKS AND MISDIRECTED SPRINKLERS
- DO NOT RAKE OR BLOW LEAVES, CLIPPINGS, OR PRUNING WASTE INTO THE STREET, GUTTER OR STORM DRAIN
- DISPOSE OF GREEN WASTE BY COMPOSTING, HAULING IT TO A PERMITTED LANDFILL, OR RECYCLING IT THROUGH YOUR CITY'S PROGRAM
- PROVIDE IPM INFORMATION TO NEW OWNERS, LESSEES AND OPERATORS
- PERIODIC INSPECTIONS FOR LEAKY, OVERFILLED, UNCOVERED, OR OTHER PROBLEMATIC CONDITIONS WILL OCCUR
- CORRECTIVE ACTION WILL BE MADE UPON DETECTION, AS CIRCUMSTANCES PERMIT
- DUMPING OF LIQUID OR HAZARDOUS WASTES WILL BE PROHIBITED
- SPILL CONTROL MATERIALS WILL BE AVAILABLE ON-SITE
- MOVE LOADED AND UNLOADED ITEMS INDOORS AS SOON AS POSSIBLE
- SWEEP PLAZAS, SIDEWALKS, AND PARKING LOTS REGULARLY TO PREVENT ACCUMULATION OF LITTER AND DEBRIS
- COLLECT DEBRIS FROM PRESSURE WASHING TO PREVENT ENTRY INTO THE STORM DRAIN SYSTEM
- COLLECT WASHWATER CONTAINING ANY CLEANING AGENT OR DEGREASER AND DISCHARGE TO THE SANITARY SEWER (NOT TO THE STORM DRAIN)
- IF INDUSTRIAL PROCESS ARE TO BE LOCATED ON SITE, ALL PROCESS ACTIVITIES TO BE PERFORMED INDOORS. NO PROCESS TO DRAIN TO EXTERIOR OR TO STORM DRAIN SYSTEM.

LID OPPORTUNITIES

1. PRESERVE EXISTING PERVIOUS AREA WHERE POSSIBLE.
2. LANDSCAPED AREAS DESIGNED TO BE SELF-RETAINING WHERE FEASIBLE.

DMAs DRAINING TO PERMANENT STRUCTURAL BMP:

DMA 1

- DMA 1-1 (ORNAMENTAL LANDSCAPING) - 41,756 S.F.
- DMA 1-2 (CONCRETE OR ASPHALT) - 49,154 S.F.
- DMA 1-3 (ROOFS) - 296,877 S.F.

TOTAL AREA = 387,787 S.F.

DMA 2

- DMA 2-1 (ORNAMENTAL LANDSCAPING) - 48,132 S.F.
- DMA 2-2 (CONCRETE OR ASPHALT) - 201,617 S.F.
- DMA 2-3 (ROOFS) - 48,778 S.F.

TOTAL AREA = 298,527 S.F.

PERMANENT STRUCTURAL BMP

- PROPOSED BIORETENTION FACILITY
 - BMP 1 (BOTTOM FOOTPRINT PROVIDED): 10,026 S.F.
 - BMP 2 (BOTTOM FOOTPRINT PROVIDED): 8,188 S.F.

GENERAL LEGEND

- DRAINAGE MANAGEMENT AREA (DMA) - OVERALL
- DRAINAGE FLOW PATH
- TRACT BOUNDARY
- CENTERLINE
- CURB AND GUTTER
- EXISTING CONTOUR LINE
- LOT LINE
- SLOPE
- ROOF DRAIN LOCATION (TRD)
- DISCHARGE LOCATION
- SUPPLEMENTAL STORAGE FOR FLOOD CONTROL PURPOSE:
 - BY BMP 1 (FOOTPRINT): ~6,950 S.F.; DEPTH=1.5'
 - BY BMP 2 (FOOTPRINT): ~9,200 S.F.; DEPTH=2.5'

DMAs DRAINING TO SELF-RETAINING AREAS:

DMA OFF1

- DMA OFF1-1 (ORNAMENTAL LANDSCAPING) - 28,450 S.F.
- DMA OFF1-2 (CONCRETE OR ASPHALT) - 14,887 S.F.
- DMA OFF1-3 (DECOMPOSED GRANITE) - 3,068 S.F.

TOTAL AREA = 46,405 S.F.

DMA OFF2

- DMA OFF2-1 (ORNAMENTAL LANDSCAPING) - 5,801 S.F.
- DMA OFF2-2 (CONCRETE OR ASPHALT) - 4,501 S.F.
- DMA OFF2-3 (DECOMPOSED GRANITE) - 2,727 S.F.

TOTAL AREA = 13,029 S.F.

MISC. - OTHER DMAs

- SELF-RETAINING AREA DMA
 - SRA OFF1 (FOOTPRINT PROVIDED): 8,623 S.F.
 - SRA OFF2 (FOOTPRINT PROVIDED): 3,376 S.F.
- SELF-TREATING AREA DMA - 21,866 S.F.
- EXISTING PAVEMENT TO BE REPLACED (UNTREATED) - 63,119 S.F.

POST-CONSTRUCTION BMP SITE PLAN PHELAN - SEATON

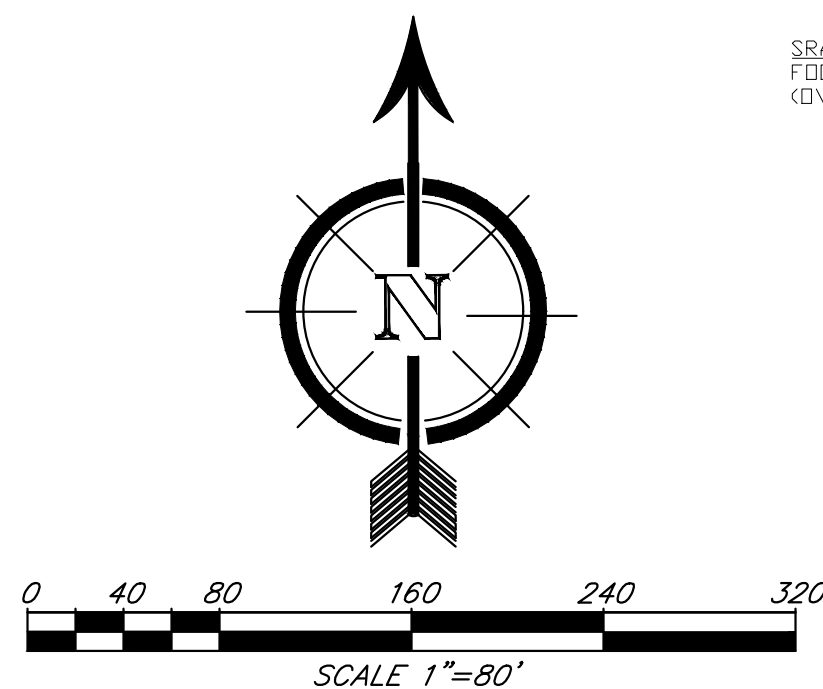
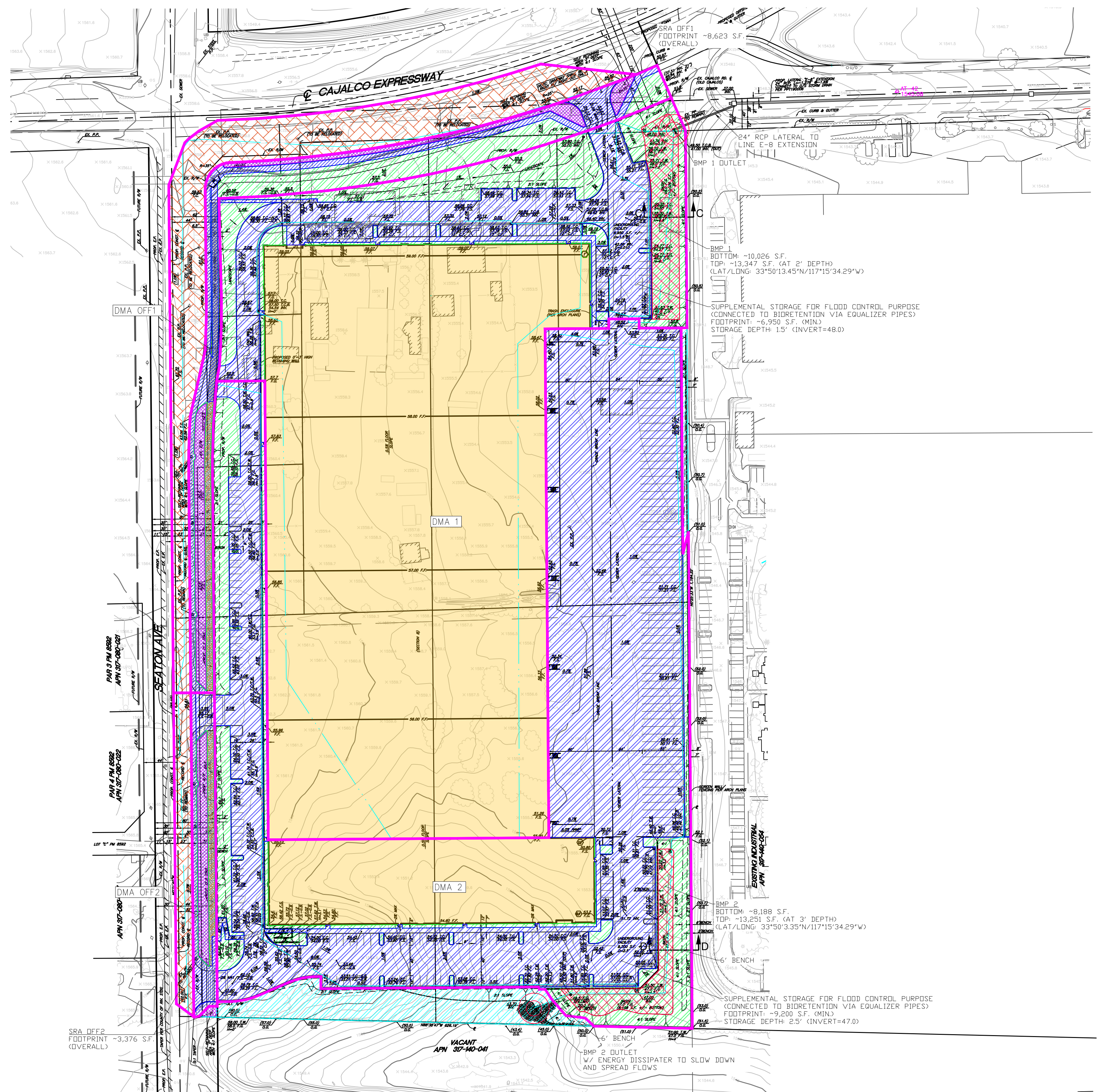

REVISED: JANUARY 2022

COUNTY OF RIVERSIDE POST-CONSTRUCTION BMP SITE PLAN DMA PLAN		1 OF
PHELAN-SEATON (CASE NO. PPT210133)		2 SHEETS

POST-CONSTRUCTION BMP SECTION DETAIL PHELAN-SEATON

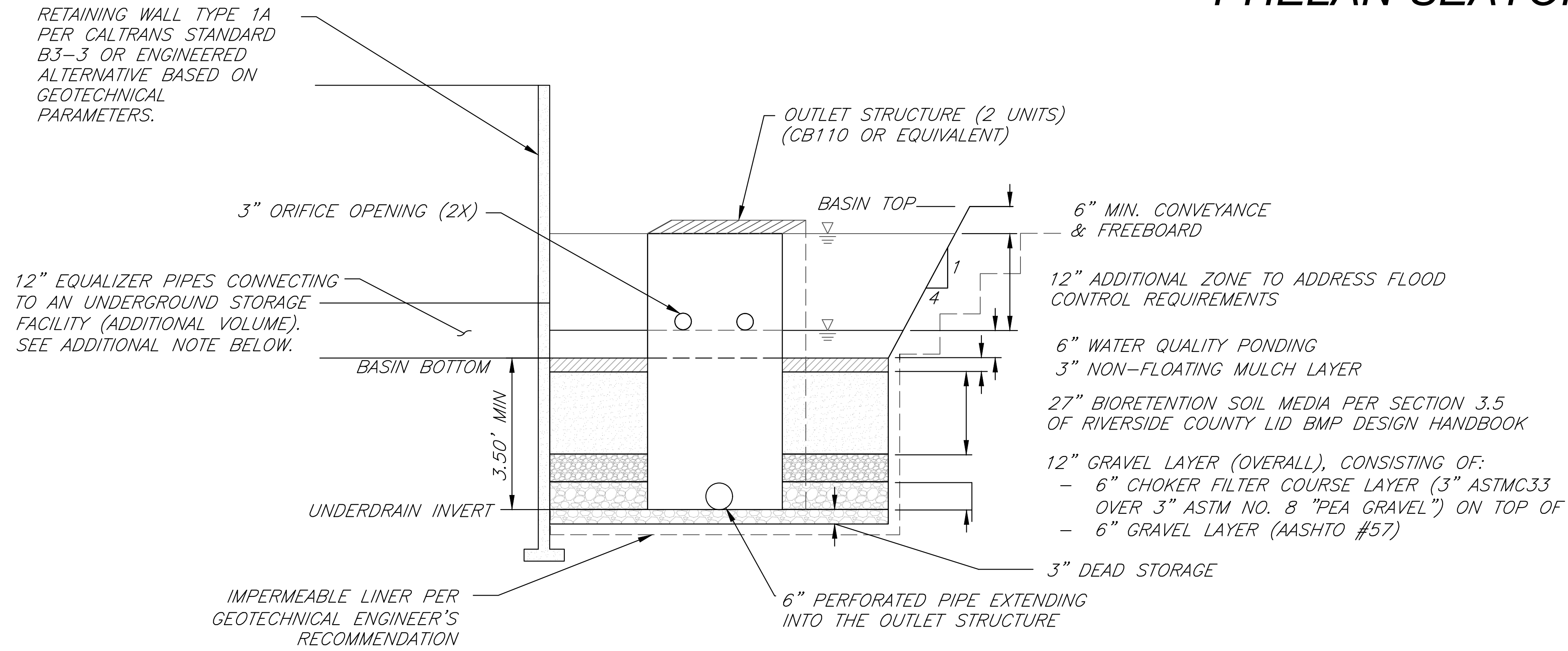

SECTION D-D: BMP 1 - BIORETENTION FACILITY - TYPICAL SECTION
NOT TO SCALE

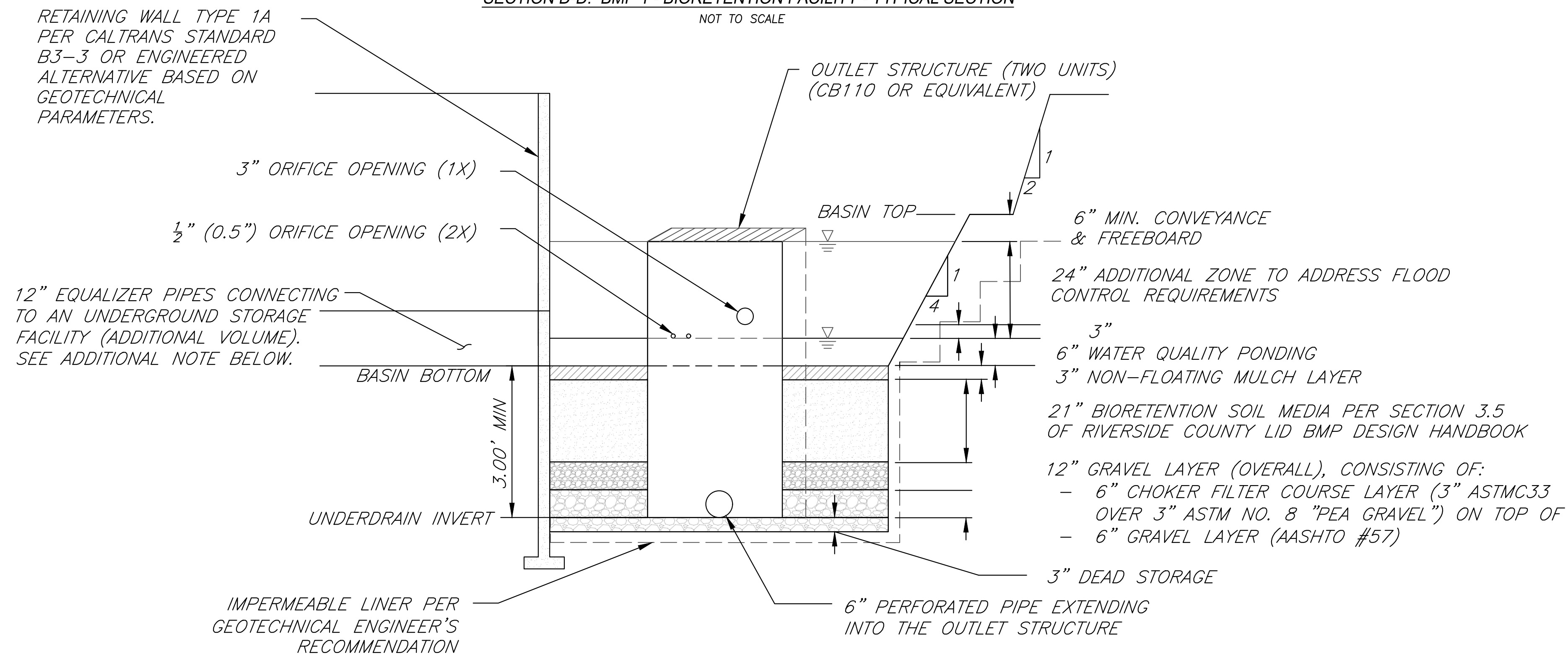

SECTION C-C: BMP 2 - BIORETENTION FACILITY - TYPICAL SECTION
NOT TO SCALE



INLET PLACARD DETAIL (TYP.)
NOT TO SCALE

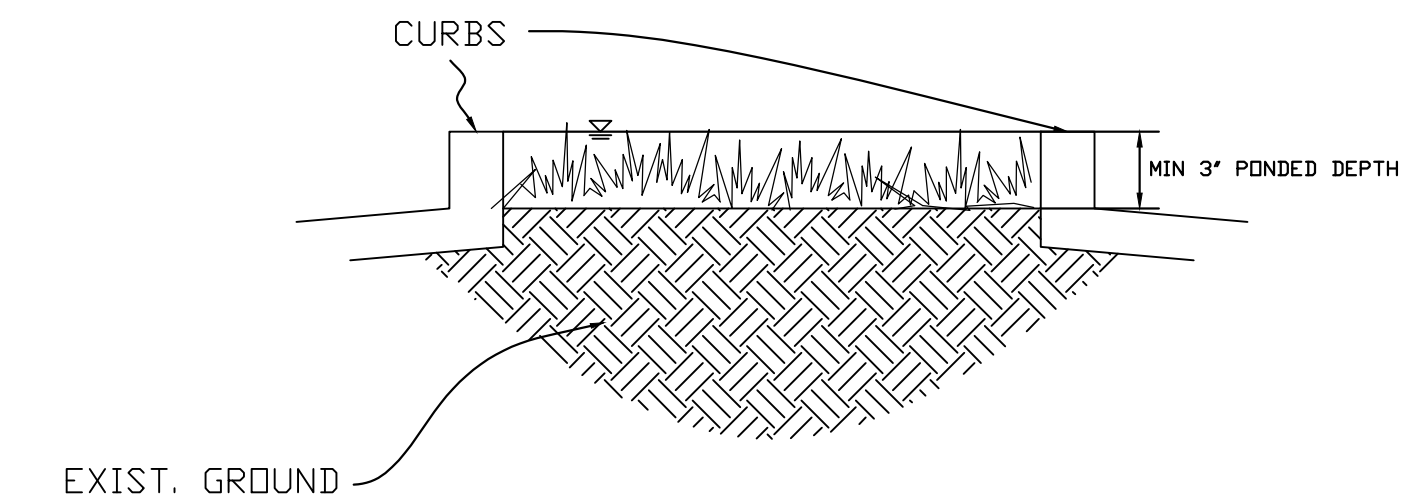

LANDSCAPED ISLAND DETAIL (TYP.)
NOT TO SCALE

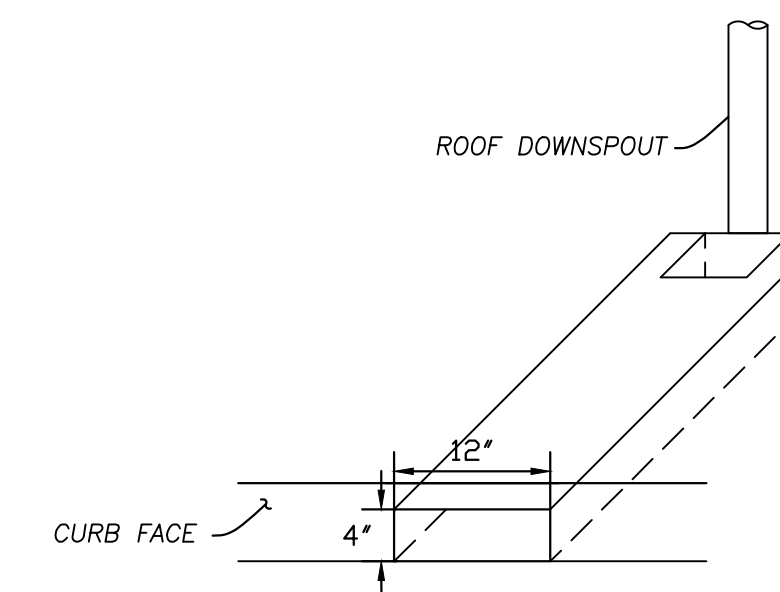

ROOF DRAIN CURB OUTLET STRUCTURE DETAIL (TYP.)
NOT TO SCALE

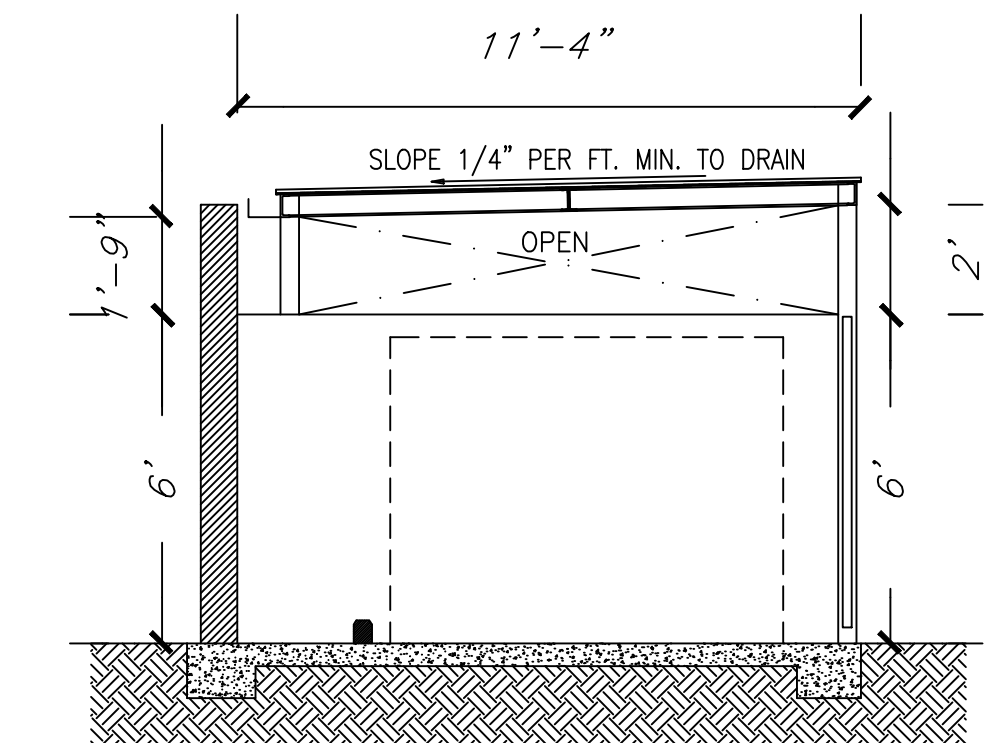

TRASH ENCLOSURE STRUCTURE DETAIL (TYP.)
NOT TO SCALE

GENERAL NOTES

1. THE PROPOSED BIORETENTION FACILITY IS EXPECTED TO FOLLOW THE RELEVANT SPECIFICATION FROM THE COUNTY OF RIVERSIDE COUNTY FLOOD CONTROL AND WATER CONSERVATION DISTRICT (RCFC&WCD) DESIGN HANDBOOK FOR LOW IMPACT DEVELOPMENT (LID) BEST MANAGEMENT PRACTICES, DATED SEPTEMBER 2011.
2. THE PROPOSED LANDSCAPING/PLANTING (PLANT PALETTE) FOR THE BIORETENTION FACILITY IS TO BE PROVIDED SEPARATELY BY THE PROJECT LANDSCAPE ARCHITECT.
3. FOR THE EMBANKMENT RELATED TO THE PROPOSED BIORETENTION FACILITY (BMP 2), A SUPPLEMENTAL LETTER HAS BEEN PREPARED BY THE PROJECT-SPECIFIC GEOTECHNICAL ENGINEER PROVIDING RECOMMENDATION AS TO ITS CONSTRUCTION AND CLARIFY THAT THE EMBANKMENT DESIGN SHOWN ON THE SITE PLAN IS ACCEPTABLE WITH 6' WIDE BENCH WITH 4:1 ENGINEERED FILL SLOPES.
4. SUPPLEMENTAL UNDERGROUND STORAGE VOLUMES (TO BMP 1 AND BMP 2) WILL BE PROVIDED IN THE PARKING AREAS TO HELP ADDRESS THE FLOOD CONTROL DETENTION CRITERIA AND THEY WILL BE CONNECTED TO THE BIORETENTION FACILITIES VIA EQUALIZER PIPES AT ELEVATIONS EQUAL TO THE BOTTOM OF THE BIORETENTION FACILITIES. FOR REFERENCE PURPOSE, SECTION DETAILS FOR THE UNDERGROUND SYSTEMS WILL BE DEVELOPED AND PROVIDED AT THE TIME OF FINAL WQMP. FOR NOW, APPROXIMATE FOOTPRINT AND DEPTH OF THE UNDERGROUND STORAGE FACILITIES ARE PROVIDED.
5. FOR THE PROPOSED SELF-RETAINING AREAS IN THE OFFSITE/FRONTAGE STREET PARKWAYS, MULTIPLE CURB CUTS WILL BE PROVIDED TO DIRECT THE FLOWS FROM THE STREET PAVEMENT TO THE LANDSCAPE/SELF-RETAINING AREAS. TYPICAL SECTION DETAILS OF THE PROPOSED SELF-RETAINING AREAS WILL BE PROVIDED AT THE TIME OF FWQMP. FOR NOW, APPROXIMATELY FOOTPRINT ARE DOCUMENTED IN SECTION C OF THE PWQMP. FOR GENERAL REFERENCE PURPOSE, PLEASE REFER TO THE PRELIMINARY GRADING PLAN (SHEET 6) FOR TYPICAL STREET SECTIONS FOR CAJALCO EXPRESSWAY AND SEATON AVENUE.

REVISED: JANUARY 2022

COUNTY OF RIVERSIDE	
POST-CONSTRUCTION BMP SITE PLAN BMP DETAILS	
PHELAN-SEATON	
(CASE NO. PPT210133)	

2
OF
2
SHEETS

Appendix 2: Construction Plans

Grading and Drainage Plans

Note: Please refer to a separate copy of the preliminary site plan provided with the overall submittal package.

Appendix 3: Soils Information

Geotechnical Study and Other Infiltration Testing Data

Geotechnical Engineering Investigation
Proposed Industrial Warehouse Development
Located at the Southeast Corner of
Seaton Avenue and Cajalco Road, Perris,
County of Riverside, California

Phelan Development Company
450 Newport Center Drive, Suite 405
Newport Beach, California 92660
Attn: Ms. Ashly McKinley

Project Number 22417-21
April 12, 2021

NorCal Engineering

TABLE OF CONTENTS

Section	Page
1.0 Project Description	2
2.0 Site Description	2
3.0 Site Exploration	2
4.0 Laboratory Tests	3
4.1 Field Moisture Content.....	4
4.2 Sieve Analyses.....	4
4.3 Maximum Density Tests.....	4
4.4 Expansion Index Tests.....	4
4.5 Atterberg Limits.....	4
4.6 Corrosion Tests.....	4
4.7 R-Value Test.....	4
4.8 Direct Shear Tests.....	4
4.9 Consolidation Tests.....	5
5.0 Seismicity Evaluation	5
6.0 Liquefaction Evaluation	6
7.0 Infiltration Characteristics	7
8.0 Conclusions and Recommendations	8
8.1 Site Grading Recommendations.....	8
8.1.1 Removal and Recomaction Recommendations.....	8
8.1.2 Fill Blanket Recommendations.....	9
8.2 Shrinkage and Subsidence.....	10
8.3 Temporary Excavations.....	10
8.4 Foundation Design.....	10
8.5 Settlement Analysis.....	11
8.6 Lateral Resistance.....	11
8.7 Retaining Wall Design Parameters.....	11
8.8 Slab Design.....	12
8.9 Pavement Section Design.....	13
8.10 Utility Trench and Excavation Backfill.....	14
8.11 Corrosion Design Criteria.....	15
8.12 Expansive Soil.....	15
9.0 Closure	15

NorCal Engineering
Soils and Geotechnical Consultants
10641 Humbolt Street Los Alamitos, CA 90720
(562) 799-9469 Fax (562) 799-9459

April 12, 2021

Project Number 22417-21

Phelan Development Company
450 Newport Center Drive, Suite 405
Newport Beach, California 92660

Attn.: Ms. Ashley McKinley

RE: Geotechnical Engineering Investigation - Proposed Industrial Warehouse Development - Located at the Southeast Corner of Seaton Avenue and Cajalco Road, Perris, in the County of Riverside, California (APN: 317-140-019, 317-140-046, 317-140-044, 317-140-045, 317-140-004, 317-140-005, 317-140-028 and 317-140-020)

Dear Ms. McKinley:

Pursuant to your request, this firm has performed a Geotechnical Engineering Investigation for the above referenced project in accordance with your approval of our proposal dated March 3, 2021. The purpose of this investigation is to evaluate the geotechnical conditions of the subject site and to provide recommendations for the proposed industrial warehouse development.

The scope of work included the following: 1) site reconnaissance; 2) subsurface geotechnical exploration and sampling; 3) laboratory testing; 4) soil infiltration testing; 5) engineering analysis of field and laboratory data; 6) preparation of a geotechnical engineering report. It is the opinion of this firm that the proposed development is feasible from a geotechnical standpoint provided that the recommendations presented in this report are followed in the design and construction of the project.

1.0 Project Description

It is proposed to construct an industrial warehouse development consisting of 365,046 square feet building as shown on the attached Site Plan by Carlile Coatsworth Architects, Inc. dated November 12, 2020. The proposed concrete tilt-up building will be supported by a conventional slab-on-grade foundation system with perimeter-spread footings and isolated interior footings. Other improvements will include asphalt and concrete pavement areas, screen walls, hardscape and landscaping. It is assumed that the proposed grading for the development will include cut and fill procedures on the order of a few feet to achieve finished grade elevations. Final building plans shall be reviewed by this firm prior to submittal for county approval to determine the need for any additional study and revised recommendations pertinent to the proposed development, if necessary.

2.0 Site Description

The 17.5-acre subject property is located at the southeast corner of Seaton Avenue and Cajalco Road, Perris, in the County of Riverside. The generally rectangular-shaped parcel is elongated in a north to south direction with topography of the relatively level descending slightly from north to south direction on the order of a few feet. The northern portion of the property consists predominately of several single family dwellings on scattered large parcels. The southern half of the property is undeveloped land covered with a moderate vegetation growth of natural grasses and weeds.

3.0 Site Exploration

The investigation consisted of the placement of five (5) exploratory borings drilled by a truck mounted hollow stem auger to depths ranging from 5 to 35 feet in depth and nine (9) exploratory trenches excavated by a backhoe to depths ranging between 5 and 15 feet below current ground elevations. The explorations were visually classified and logged by a field engineer with locations of the subsurface explorations shown on the attached site plan. The exploratory borings/trenches revealed the existing earth materials to consist of fill and natural soil. Detailed descriptions of the subsurface conditions are listed on the boring/trench logs in Appendix A. It should be noted that the transition from one soil type to another as shown on the boring logs is approximate and may in fact be a gradual transition. The soils encountered are described as follows:

Fill: A fill soil classifying as a brown, sandy SILT to sandy CLAY was encountered across the site to a depth of one foot below ground surface. These soils were noted to be soft and moist.

Natural: A natural undisturbed soil classifying predominantly as a brown, sandy SILT to sandy CLAY was encountered beneath the fill soils. The native soils were observed to be stiff and damp to moist. Deeper soils consisted of a brown silty to clayey SAND which were noted to be dense and damp to moist. A grey brown, fine to coarse grained, silty SAND (Decomposed Granite) was also encountered at a depth of 26.5 feet below ground surface in Exploratory Boring B-1. These materials were observed to be dense to very dense and damp.

The overall engineering characteristics of the earth material were relatively uniform with each excavation. No groundwater was encountered to the depth of explorations and no caving occurred.

4.0 Laboratory Tests

Relatively undisturbed samples of the subsurface soils were obtained to perform laboratory testing and analysis for direct shear, consolidation tests, and to determine in-place moisture/densities. These relatively undisturbed ring samples were obtained by driving a thin-walled steel sampler lined with one-inch long brass rings with an inside diameter of 2.42 inches into the undisturbed soils. Bulk bag samples were obtained in the upper soils for expansion index tests and maximum density tests. All test results are included in Appendix B, unless otherwise noted.

Standard penetration tests were obtained by driving a steel sampler unlined with an inside diameter of 1.5 inches into the soils. This standard penetrometer sampler was driven a total of eighteen inches with blow counts tallied every six inches. Blow count data is given on the Boring Logs in Appendix A. Bulk bag samples were obtained in the upper soils for expansion index tests and maximum density tests. All test results are included in Appendix B, unless otherwise noted.

- 4.1 **Field Moisture Content** (ASTM: D 2216) and the dry density of the ring samples were determined in the laboratory. This data is listed on the logs of explorations.
- 4.2 **Sieve analyses** (ASTM: D 422-63) and the percent by weight of soil finer than the No. 200 sieve (ASTM: 1140) were performed on selected soil samples. These results are shown later within the body of this report.
- 4.3 **Maximum Density tests** (ASTM: D 1557) were performed on typical samples of the upper soils. Results of these tests are shown on Table I.
- 4.4 **Expansion Index tests** (ASTM: D 4829) were performed on remolded samples of the upper soils to determine expansive characteristics. Results of these tests are provided on Table II.
- 4.5 **Atterberg Limits** (ASTM: D 4318) consisting of liquid limit, plastic limit and plasticity index were performed on representative soil samples. Results are shown on Table III.
- 4.6 **Corrosion tests** consisting of sulfate, pH, resistivity and chloride analysis to determine potential corrosive effects of soils on concrete and underground utilities. Test results are provided on Table IV.
- 4.7 **R-Value test** per California Test Method 301 was performed on a representative sample, which may be anticipated to be near subgrade to determine pavement design. Results are provided within the pavement design section of the report.
- 4.8 **Direct Shear tests** (ASTM: D 3080) were performed on undisturbed and/or remolded samples of the subsurface soils. The test is performed under saturated conditions at loads of 1,000 lbs./sq.ft., 2,000 lbs./sq.ft., and 3,000 lbs./sq.ft. with results shown on Plates A and B.

4.9 **Consolidation tests** (ASTM: D 2435) were performed on undisturbed samples to determine the differential and total settlement which may be anticipated based upon the proposed loads. Water was added to the samples at a surcharge of one KSF and the settlement curves are plotted on Plates C to E.

5.0 Seismicity Evaluation

The proposed development lies outside of any Alquist Priolo Special Studies Zone and the potential for damage due to direct fault rupture is considered unlikely. The site is situated in an area of high regional seismicity and the San Jacinto (San Jacinto Valley) fault is located about 15 kilometers from the site. Ground shaking originating from earthquakes along other active faults in the region is expected to induce lower horizontal accelerations due to smaller anticipated earthquakes and/or greater distances to other faults. The seismic design parameters are provided below and are based on the 2019 California Building Code (CBC) Standard ASCE/SEI 7-16. The data was obtained from the American Society of Civil Engineers (ASCE) website, <https://asce7hazardtool.online/>. The ASCE 7 Hazards Report is attached in Appendix C.

Seismic Design Acceleration Parameters

Latitude	33.836
Longitude	-117.261
Site Class	D
Risk Category	II
Mapped Spectral Response Acceleration	$S_S = 1.500$ $S_1 = 0.557$
Adjusted Maximum Acceleration	$S_{MS} = 1.500$
Design Spectral Response Acceleration Parameters	$S_{DS} = 1.000$
Peak Ground Acceleration	$PGA_M = 0.550$

Use of these values is dependent on requirements of ASCE 7-16, 11-4.8, Exception 2 that requires the value of the seismic response coefficient C_s be determined by Equation 12.8.2 for values of $T \leq 1.5T_s$ and taken as equal to 1.5 times the value computed in accordance with either 12.8-3 for $T_L \geq T \geq 1.5T_s$ or Equation 12.8-4 for $T > T_L$. Computations and verification of these conditions is referred to the structural engineer.

6.0 Liquefaction Evaluation

The site is expected to experience ground shaking and earthquake activity that is typical of Southern California area. It is during severe ground shaking that loose, granular soils below the groundwater table can liquefy. A review of the exploratory boring log and the laboratory test results on selected soil samples obtained indicate the following soil classifications, field blowcounts and amounts of fines passing through the No. 200 sieve.

Field Blowcount and Gradation Data

Boring No.	Classification	Blowcounts (blows/ft)	Relative Density	% Passing No. 200 Sieve
B-1 @ 5'	ML	52	Very Stiff	51
B-1 @ 10'	SM	20	Dense	35
B-1 @ 15'	SC	32	Very Dense	49
B-1 @ 20'	SC	32	Very Dense	50
B-1 @ 25'	SC	27	Dense	42
B-1 @ 30'	SW/SM	57	Very Dense	11
B-1 @ 35'	SW/SM	>50	Very Dense	14

Based on review of the *County of Riverside– Liquefaction Zone Map (September 2019)*, the site is situated in an area of moderate liquefaction susceptibility. Our analysis indicates the potential for liquefaction at this site to be very low due to the dense and very dense subsurface soils. A very dense decomposed granite was encountered at 26.5 feet below ground surface and Exploratory Boring B-1 met refusal at a depth of 35 feet. No groundwater was encountered to the depth of our boring.

Based on our analysis, the seismic-induced settlements will be on the order of less than one inch and would occur rather uniformly across the site. Differential settlements would be on the order of ½ inch over a 50-foot (horizontal) distance. Thus, the design of the proposed construction in conformance with the latest Building Code provisions for earthquake design is expected to provide mitigation of ground shaking hazards that are typical to Southern California.

7.0 Infiltration Characteristics

Infiltration tests within the site were performed to provide preliminary infiltration rates for the purpose of planning and design of an on-site water disposal system. The infiltration tests consisted of the double ring infiltration test per ASTM Method D 3385. The field infiltration rate was computed using a reduction factor – R_f based on the field measurements with our calculations given in Appendix D. Based upon the results of our testing, the soils encountered in the planned on-site drainage disposal system area exhibit the following infiltration rates.

Trench/Test No.	Depth	Soil Classification	Field Infiltration Rate	Design Rate
T-1/TH-1	5'	Silty SAND	18.8 in/hr	6.2 in/hr
T-2/TH-2	10'	Sandy CLAY	0.2in/hr	0.7 in/hr
T-3/TH-3	6'	Silty SAND	20.2 in/hr	6.7 in/hr
T-4/TH-4	5'	Sandy SILT	7.6 in/hr	2.5 in/hr

The correction factors CF_t, CF_v and CF_s are given below based on soils between 5 and 10 feet from our field tests.

- a) CF_t = R_f = 1.0 for our double ring infiltration test holes.
- b) CF_v = 1.0 based on uniform soils encountered in four (4) trenches for infiltration tests.
- c) CF_s = 3.0 for long-term siltation, plugging and maintenance. The subsurface soils are likely to have some plugging and regular maintenance of storm water discharge devices is required.

All systems must meet the latest county specifications and the California Regional Water Quality Control Board (CRWQCB) requirements. It is recommended that foundations shall be setback a minimum distance of 10 feet from the drainage disposal system and the bottom of footing shall be a minimum of 10 feet from the expected zone of saturation. The boundary of the zone of saturation may be assumed to project downward from the top of the permeable portion of the disposal system at an inclination of 1 to 1 or flatter, as determined by the geotechnical engineer.

8.0 Conclusions and Recommendations

Based upon our evaluations, the proposed development is acceptable from a geotechnical engineering standpoint. By following the recommendations and guidelines set forth in our report, the structures will be safe from excessive settlements under the anticipated design loadings and conditions. The proposed development shall meet all requirements of the City Building Ordinance and will not impose any adverse effect on existing adjacent structures.

The following recommendations are based upon soil conditions encountered in our field investigation; these near-surface soil conditions could vary across the site. Variations in the soil conditions may not become evident until the commencement of grading operations for the proposed development and revised recommendations from the soils engineer may be necessary based upon the conditions encountered. It is recommended that site inspections be performed by a representative of this firm during all grading and construction of the development to verify the findings and recommendations documented in this report. Any unusual conditions which may be encountered in the course of the project development may require the need for additional study and revised recommendations.

8.1 Site Grading Recommendations

Any vegetation and/or demolition debris shall be removed and hauled from proposed grading areas prior to the start of grading operations. Existing vegetation shall not be mixed or disced into the soils. Any removed soils may be reutilized as compacted fill once any deleterious material or oversized materials (in excess of eight inches) is removed. Grading operations shall be performed in accordance with the attached *Specifications for Placement of Compacted Fill*.

8.1.1 Removal and Recompaction Recommendations

All disturbed soils and/or fill (about one foot below ground surface) shall be removed to competent native material, the exposed surface scarified to a depth of 12 inches, brought to within 2% of optimum moisture content and compacted to a minimum of 90% of the laboratory standard (ASTM: D 1557) prior to placement of any additional compacted fill soils, foundations, slabs-on-grade and pavement. Grading shall extend a minimum of five horizontal feet outside the edges of foundations or equidistant to the depth of fill placed, whichever is greater.

It is possible that isolated areas of undiscovered fill not described in this report are present on site; if found, these areas should be treated as discussed earlier. A diligent search shall also be conducted during grading operations in an effort to uncover any underground structures, irrigation or utility lines. If encountered, these structures and lines shall be either removed or properly abandoned prior to the proposed construction.

Any imported fill material should be preferably soil similar to the upper soils encountered at the subject site. All soils shall be approved by this firm prior to importing at the site and will be subjected to additional laboratory testing to assure concurrence with the recommendations stated in this report.

If placement of slabs-on-grade and pavement is not completed immediately upon completion of grading operations, additional testing and grading of the areas may be necessary prior to continuation of construction operations. Likewise, if adverse weather conditions occur which may damage the subgrade soils, additional assessment by the soils engineer as to the suitability of the supporting soils may be needed.

Care should be taken to provide or maintain adequate lateral support for all adjacent improvements and structures at all times during the grading operations and construction phase. Adequate drainage away from the structures, pavement and slopes should be provided at all times.

8.1.2 **Fill Blanket Recommendations**

Due to the potential for differential settlement of foundations placed on compacted fill and native materials, it is recommended that all foundations including floor slab areas be underlain by a uniform compacted fill blanket at least two feet in thickness. This fill blanket shall extend a minimum of five horizontal feet outside the edges of foundations or equidistant to the depth of fill placed, whichever is greater.

8.2 Shrinkage and Subsidence

Results of our in-place density tests reveal that the soil shrinkage will be on the order of 5 to 10% due to excavation and recompaction, based upon the assumption that the fill is compacted to 92% of the maximum dry density per ASTM standards. Subsidence should be 0.2 feet due to earthwork operations. The volume change does not include any allowance for vegetation or organic stripping, removal of subsurface improvements, or topographic approximations. Although these values are only approximate, they represent our best estimate of lost yardage, which will likely occur during grading. If more accurate shrinkage and subsidence factors are needed, it is recommended that field testing the actual equipment and grading techniques should be conducted.

8.3 Temporary Excavations

Temporary unshored excavations in the existing site materials may be made at vertical inclinations up to 4 feet in height unless cohesionless soils are encountered. In areas where soils with little or no binder are encountered, where adverse geological conditions are exposed, or where excavations are adjacent to existing structures, shoring or flatter excavations may be required. The temporary cut slope gradients given above do not preclude local raveling and sloughing. All excavations shall be made in accordance with the requirements of the soils engineer, CAL-OSHA and other public agencies having jurisdiction. Care should be taken to provide or maintain adequate lateral support for all adjacent improvements and structures at all times during the grading operations and construction phase.

8.4 Foundation Design

All foundations may be designed utilizing the following allowable bearing capacities for an embedded depth of 24 inches into approved engineered fill with the corresponding widths:

Allowable Bearing Capacity (psf)		
Width (feet)	Continuous Foundation	Isolated Foundation
1.5	2000	2500
2.0	2075	2575
4.0	2375	2875
6.0	2500	3000

The bearing value may be increased by 500 psf for each additional foot of depth in excess of the 24-inch minimum depth, up to a maximum of 4,000 psf. A one-third increase may be used when considering short-term loading and seismic forces. Any foundations located along property line may utilize an allowable bearing capacity of 2,000 psf and embedded into competent native soils. All foundations shall be reinforced a minimum of one, No. 4 bar, top and bottom. A representative of this firm shall inspect all foundation excavations prior to pouring concrete.

8.5 Settlement Analysis

Resultant pressure curves for the consolidation tests are shown on Plates C to E. Computations utilizing these curves and the recommended allowable soil bearing capacities reveal that the foundations will experience settlements on the order of $\frac{3}{4}$ inch and differential settlements of less than $\frac{1}{4}$ inch.

8.6 Lateral Resistance

The following values may be utilized in resisting lateral loads imposed on the structure. Requirements of the California Building Code should be adhered to when the coefficient of friction and passive pressures are combined.

Coefficient of Friction - 0.35

Equivalent Passive Fluid Pressure = 200 lbs./cu.ft.

Maximum Passive Pressure = 2,000 lbs./cu.ft.

The passive pressure recommendations are valid only for approved compacted fill soils or competent native materials.

8.7 Retaining Wall Design Parameters

Active earth pressures against retaining walls will be equal to the pressures developed by the following fluid densities. These values are for **approved granular backfill material** placed behind the walls at various ground slopes above the walls.

Surface Slope of Retained Materials (Horizontal to Vertical)	Equivalent Fluid Density (lb./cu.ft.)
Level	30
5 to 1	35
4 to 1	38
3 to 1	40
2 to 1	45

Any applicable short-term construction surcharges and seismic forces should be added to the above lateral pressure values. An equivalent fluid pressure of 45 pcf may be utilized for the restrained wall condition with a level grade behind the wall.

The seismic-induced lateral soil pressure for walls greater than 6 feet may be computed using a triangular pressure distribution with the maximum value at the top of the wall. The maximum lateral pressure of (20 pcf) H where H is the height of the retained soils above the wall footing should be used in final design of retaining walls. Sliding resistance values and passive fluid pressure values may be increased by 1/3 during short-term wind and seismic loading conditions.

All walls shall be waterproofed as needed and protected from hydrostatic pressure by a reliable permanent subdrain system. The granular backfill to be utilized immediately adjacent to retaining walls shall consist of an approved select granular soil with a sand equivalency greater than 30. This backfill zone of free draining material shall consist of a wedge beginning a minimum of one horizontal foot from the base of the wall extending upward at an inclination of no less than $\frac{3}{4}$ to 1 (horizontal to vertical).

8.8 Slab Design

All concrete slabs shall be a minimum of six inches in thickness in the proposed warehouse areas and four inches in office and hardscape both reinforced a minimum of No. 3 bars, sixteen inches in each direction and positioned in the center of slab and placed on approved subgrade soils moisture conditioned to 3% over optimum moisture content to a depth eighteen inches.

Additional reinforcement requirements and an increase in thickness of the slabs-on-grade may be necessary based upon soils expansion potential and proposed loading conditions in the structures and should be evaluated further by the project engineers and/or architect.

A vapor retarder (10-mil minimum thickness) should be utilized in areas which would be sensitive to the infiltration of moisture. This retarder shall meet requirements of ASTM E 96, *Water Vapor Transmission of Materials* and ASTM E 1745, *Standard Specification for Water Vapor Retarders used in Contact with Soil or Granular Fill Under Concrete Slabs*. The vapor retarder shall be installed in accordance with procedures stated in ASTM E 1643, *Standard practice for Installation of Water Vapor Retarders used in Contact with Earth or Granular Fill Under Concrete Slabs*.

The moisture retarder may be placed directly upon compacted subgrade soils conditioned to near optimum moisture levels, although one to two inches of sand beneath the membrane is desirable. The subgrade upon which the retarder is placed shall be smooth and free of rocks, gravel or other protrusions which may damage the retarder. Use of sand above the retarder is under the purview of the structural engineer; if sand is used over the retarder, it should be placed in a dry condition.

8.9 Pavement Section Design

The table on the following page provides a preliminary pavement design based upon an R-Value of 7 for the subgrade soils for the proposed pavement areas. Final pavement design may need to be based on R-Value testing of the subgrade soils near the conclusion of site grading to assure that these soils are consistent with those assumed in this preliminary design.

The recommendations are based upon estimated traffic loads. Client should submit any other anticipated traffic loadings to the geotechnical engineer, if necessary, so that pavement sections may be reviewed to determine adequacy to support the proposed loadings.

Type of Traffic	Traffic Index	Asphalt (in.)	Base Material (in.)
Automobile Parking Stalls	4.0	3.0	7.0
Light Vehicle Circulation Areas	6.0	4.0	12.0
Heavy Truck Access Areas	7.0	4.5	16.0

Any concrete slab-on-grade in pavement areas shall be a minimum of seven inches in thickness and may be placed on approved subgrade soils. All pavement areas shall have positive drainage toward an approved outlet from the site. Drain lines behind curbs and/or adjacent to landscape areas should be considered by client and the appropriate design engineers to prevent water from infiltrating beneath pavement. If such infiltration occurs, damage to pavement, curbs and flow lines, especially on sites with expansive soils, may occur during the life of the project.

Any approved base material shall consist of a Class II aggregate or equivalent and should be compacted to a minimum of 95% relative compaction. All pavement materials shall conform to the requirements set forth by the County of Riverside. The base material; and asphaltic concrete should be tested prior to delivery to the site and during placement to determine conformance with the project specifications. A pavement engineer shall designate the specific asphalt mix design to meet the required project specifications.

8.10 **Utility Trench and Excavation Backfill**

Trenches from installation of utility lines and other excavations may be backfilled with on-site soils or approved imported soils compacted to a minimum of 90% relative compaction. All utility lines shall be properly bedded with clean sand having a sand equivalency rating of 30 or more. This bedding material shall be thoroughly water jetted around the pipe structure prior to placement of compacted backfill soils.

8.11 Corrosion Design Criteria

Representative samples of the surficial soils, typical of the subgrade soils expected to be encountered within foundation excavations and underground utilities were tested for corrosion potential. The minimum resistivity value obtained for the samples tested is representative of an environment that may be severely corrosive to metals. The soil pH value was considered mildly acidic and may not have a significant effect on soil corrosivity. Consideration should be given to corrosion protection systems for buried metal such as protective coatings, wrappings or the use of PVC where permitted by local building codes.

According to Table 4.3.1 of ACI 318 Building Code and Commentary, these contents revealed negligible sulfate concentrations. Therefore, a Type II cement according to latest CBC specifications may be utilized for building foundations at this time. It is recommended that additional sulfate tests be performed at the completion of site grading to assure that the as graded conditions are consistent with the recommendations stated in this design. Corrosion test results may be found on the attached Table IV.

8.12 Expansive Soil

Since expansive soils were encountered, special attention should be given to the project design and maintenance. The attached *Expansive Soil Guidelines* should be reviewed by the engineers, architects, owner, maintenance personnel and other interested parties and considered during the design of the project and future property maintenance.

9.0 Closure

The recommendations and conclusions contained in this report are based upon the soil conditions uncovered in our test excavations. No warranty of the soil condition between our excavations is implied. NorCal Engineering should be notified for possible further recommendations if unexpected to unfavorable conditions are encountered during construction phase. It is the responsibility of the owner to ensure that all information within this report is submitted to the Architect and appropriate Engineers for the project.

A preconstruction conference should be held between the developer, general contractor, grading contractor, city inspector, architect, and geotechnical engineer to clarify any questions relating to the grading operations and subsequent construction. Our representative should be present during the grading operations and construction phase to certify that such recommendations are complied within the field.

This geotechnical investigation has been conducted in a manner consistent with the level of care and skill exercised by members of our profession currently practicing under similar conditions in the Southern California area. No other warranty, expressed or implied is made.

We appreciate this opportunity to be of service to you. If you have any further questions, please do not hesitate to contact the undersigned.

Respectfully submitted,
NORCAL ENGINEERING



Keith D. Tucker
Project Engineer
R.G.E. 841



Scott D. Spensiero
Project Manager

SPECIFICATIONS FOR PLACEMENT OF COMPACTED FILL

Excavation

Any existing low-density soils and/or saturated soils shall be removed to competent natural soil under the inspection of the Geotechnical Engineering Firm. After the exposed surface has been cleansed of debris and/or vegetation, it shall be scarified until it is uniform in consistency, brought to the proper moisture content and compacted to a minimum of 90% relative compaction (in accordance with ASTM: D 1557).

In any area where a transition between fill and native soil or between bedrock and soil are encountered, additional excavation beneath foundations and slabs will be necessary in order to provide uniform support and avoid differential settlement of the structure.

Material for Fill

The on-site soils or approved import soils may be utilized for the compacted fill provided they are free of any deleterious materials and shall not contain any rocks, brick, asphaltic concrete, concrete or other hard materials greater than eight inches in maximum dimensions. Any import soil must be approved by the Geotechnical Engineering firm a minimum of 72 hours prior to importation of site.

Placement of Compacted Fill Soils

The approved fill soils shall be placed in layers not excess of six inches in thickness. Each lift shall be uniform in thickness and thoroughly blended. The fill soils shall be brought to within 2% of the optimum moisture content, unless otherwise specified by the Soils Engineering firm. Each lift shall be compacted to a minimum of 90% relative compaction (in accordance with ASTM: D 1557) and approved prior to the placement of the next layer of soil. Compaction tests shall be obtained at the discretion of the Geotechnical Engineering firm but to a minimum of one test for every 500 cubic yards placed and/or for every 2 feet of compacted fill placed.

The minimum relative compaction shall be obtained in accordance with accepted methods in the construction industry. The final grade of the structural areas shall be in a dense and smooth condition prior to placement of slabs-on-grade or pavement areas. No fill soils shall be placed, spread or compacted during unfavorable weather conditions. When the grading is interrupted by heavy rains, compaction operations shall not be resumed until approved by the Geotechnical Engineering firm.

Grading Observations

The controlling governmental agencies should be notified prior to commencement of any grading operations. This firm recommends that the grading operations be conducted under the observation of a Soils Engineering firm as deemed necessary. A 24-hour notice must be provided to this firm prior to the time of our initial inspection.

Observation shall include the clearing and grubbing operations to assure that all unsuitable materials have been properly removed; approve the exposed subgrade in areas to receive fill and in areas where excavation has resulted in the desired finished grade and designate areas of overexcavation; and perform field compaction tests to determine relative compaction achieved during fill placement. In addition, all foundation excavations shall be observed by the Geotechnical Engineering firm to confirm that appropriate bearing materials are present at the design grades and recommend any modifications to construct footings.

EXPANSIVE SOIL GUIDELINES

The following expansive soil guidelines are provided for your project. The intent of these guidelines is to inform you, the client, of the importance of proper design and maintenance of projects supported on expansive soils. ***You, as the owner or other interested party, should be warned that you have a duty to provide the information contained in the soil report including these guidelines to your design engineers, architects, landscapers and other design parties in order to enable them to provide a design that takes into consideration expansive soils.***

In addition, you should provide the soil report with these guidelines to any property manager, lessee, property purchaser or other interested party that will have or assume the responsibility of maintaining the development in the future.

Expansive soils are fine-grained silts and clays which are subject to swelling and contracting. The amount of this swelling and contracting is subject to the amount of fine-grained clay materials present in the soils and the amount of moisture either introduced or extracted from the soils. Expansive soils are divided into five categories ranging from “very low” to “very high”. Expansion indices are assigned to each classification and are included in the laboratory testing section of this report. *If the expansion index of the soils on your site, as stated in this report, is 21 or higher, you have expansive soils.* The classifications of expansive soils are as follows:

Classification of Expansive Soil*

Expansion Index	Potential Expansion
0-20	Very Low
21-50	Low
51-90	Medium
91-130	High
Above 130	Very High

*From Table 18A-I-B of California Building Code (1988)

When expansive soils are compacted during site grading operations, care is taken to place the materials at or slightly above optimum moisture levels and perform proper compaction operations. Any subsequent excessive wetting and/or drying of expansive soils will cause the soil materials to expand and/or contract. These actions are likely to cause distress of foundations, structures, slabs-on-grade, sidewalks and pavement over the life of the structure. ***It is therefore imperative that even after construction of improvements, the moisture contents are maintained at relatively constant levels, allowing neither excessive wetting or drying of soils.***

Evidence of excessive wetting of expansive soils may be seen in concrete slabs, both interior and exterior. Slabs may lift at construction joints producing a trip hazard or may crack from the pressure of soil expansion. Wet clays in foundation areas may result in lifting of the structure causing difficulty in the opening and closing of doors and windows, as well as cracking in exterior and interior wall surfaces. In extreme wetting of soils to depth, settlement of the structure may eventually result. Excessive wetting of soils in landscape areas adjacent to concrete or asphaltic pavement areas may also result in expansion of soils beneath pavement and resultant distress to the pavement surface.

Excessive drying of expansive soils is initially evidenced by cracking in the surface of the soils due to contraction. Settlement of structures and on-grade slabs may also eventually result along with problems in the operation of doors and windows.

Projects located in areas of expansive clay soils will be subject to more movement and "hairline" cracking of walls and slabs than similar projects situated on non-expansive sandy soils. There are, however, measures that developers and property owners may take to reduce the amount of movement over the life the development. The following guidelines are provided to assist you in both design and maintenance of projects on expansive soils:

- Drainage away from structures and pavement is essential to prevent excessive wetting of expansive soils. Grades should be designed to the latest building code and maintained to allow flow of irrigation and rain water to approved drainage devices or to the street. Any “ponding” of water adjacent to buildings, slabs and pavement after rains is evidence of poor drainage; the installation of drainage devices or regrading of the area may be required to assure proper drainage. Installation of rain gutters is also recommended to control the introduction of moisture next to buildings. Gutters should discharge into a drainage device or onto pavement which drains to roadways.
- Irrigation should be strictly controlled around building foundations, slabs and pavement and may need to be adjusted depending upon season. This control is essential to maintain a relatively uniform moisture content in the expansive soils and to prevent swelling and contracting. Over-watering adjacent to improvements may result in damage to those improvements. NorCal Engineering makes no specific recommendations regarding landscape irrigation schedules.
- Planting schemes for landscaping around structures and pavement should be analyzed carefully. Plants (including sod) requiring high amounts of water may result in excessive wetting of soils. Trees and large shrubs may actually extract moisture from the expansive soils, thus causing contraction of the fine-grained soils.
- Thickened edges on exterior slabs will assist in keeping excessive moisture from entering directly beneath the concrete. A six-inch thick or greater deepened edge on slabs may be considered. Underlying interior and exterior slabs with 6 to 12 inches or more of non-expansive soils and providing presaturation of the underlying clayey soils as recommended in the soil report will improve the overall performance of on-grade slabs.

- Increase the amount of steel reinforcing in concrete slabs, foundations and other structures to resist the forces of expansive soils. The precise amount of reinforcing should be determined by the appropriate design engineers and/or architects.
- Recommendations of the soil report should always be followed in the development of the project. Any recommendations regarding presaturation of the upper subgrade soils in slab areas should be performed in the field and verified by the Soil Engineer.

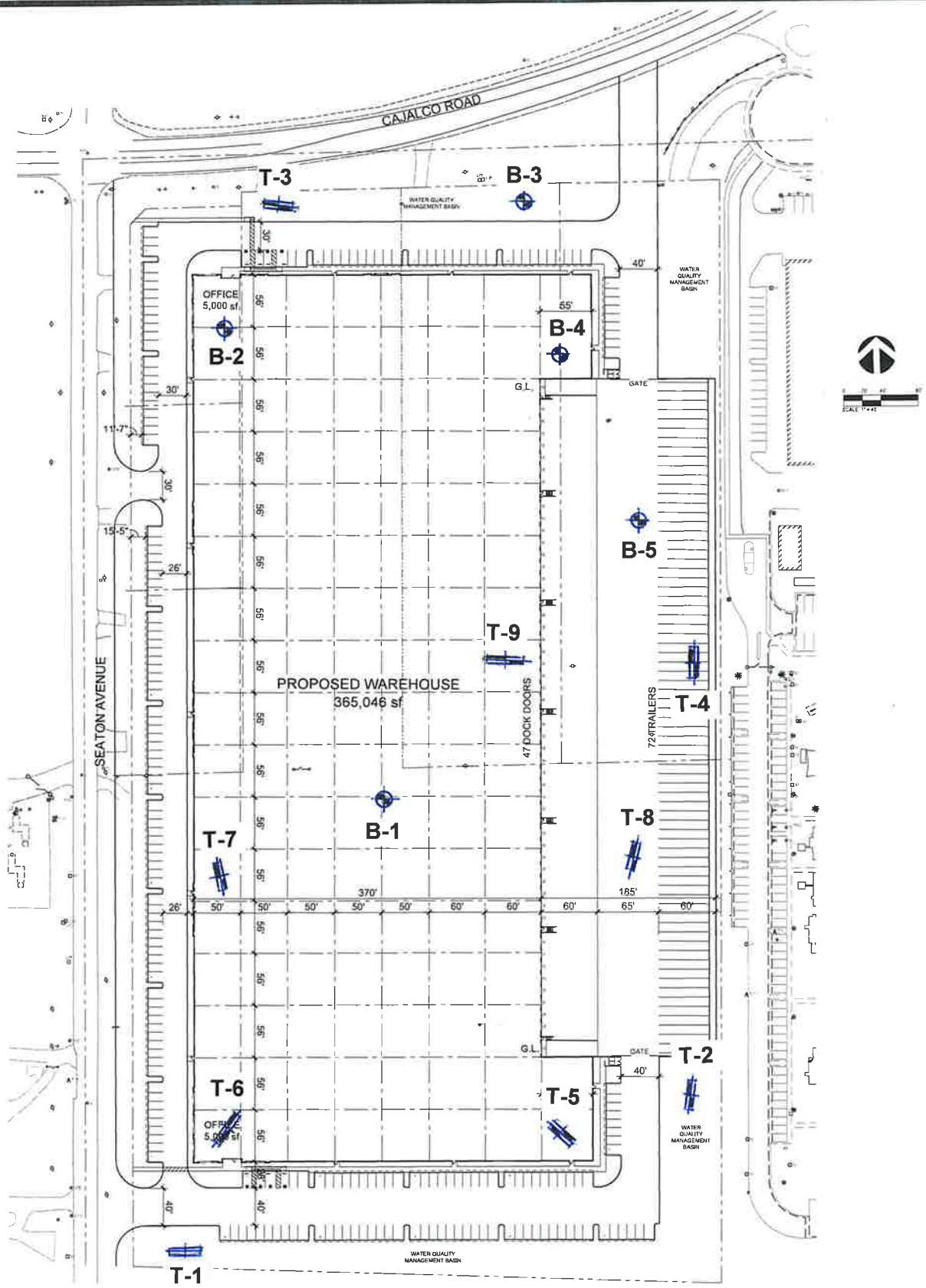

NorCal Engineering
 SOILS AND GEOTECHNICAL CONSULTANTS

SITE PLAN

PROJECT: 22417-21

DATE: APRIL 2021

List of Appendices **(in order of appearance)**

Appendix A – Log of Excavations

Log of Borings B-1 to B-5
Log of Trenches T-1 to T-9

Appendix B – Laboratory Tests

Table I – Maximum Dry Density
Table II – Expansion
Table III – Atterberg Limits
Table IV – Corrosion
R Value
Plates A and B – Direct Shear
Plates C to E - Consolidation

Appendix C – Seismic Design Report

Seismic Design Report

Appendix D – Soil Infiltration Data

Field Tests and Calculations

Appendix A

Log of Excavations

MAJOR DIVISION			GRAPHIC SYMBOL	LETTER SYMBOL	TYPICAL DESCRIPTIONS	
COARSE GRAINED SOILS	GRAVEL AND GRAVELLY SOILS	CLEAN GRAVELS (LITTLE OR NO FINES)		GW	WELL-GRADED GRAVELS, GRAVEL-SAND MIXTURES, LITTLE OR NO FINES	
				GP	POORLY-GRADED GRAVELS, GRAVEL-SAND MIXTURES, LITTLE OR NO FINES	
		MORE THAN 50% OF COARSE FRACTION RETAINED ON NO. 4 SIEVE	GRAVELS WITH FINES (APPRECIABLE AMOUNT OF FINES)		GM	SILTY GRAVELS, GRAVEL-SAND-SILT MIXTURES
				GC	CLAYEY GRAVELS, GRAVEL-SAND-CLAY MIXTURES	
	SAND AND SANDY SOILS	CLEAN SAND (LITTLE OR NO FINES)		SW	WELL-GRADED SANDS, GRAVELLY SANDS, LITTLE OR NO FINES	
				SP	POORLY-GRADED SANDS, GRAVELLY SANDS, LITTLE OR NO FINES	
		MORE THAN 50% OF COARSE FRACTION PASSING ON NO. 4 SIEVE	SANDS WITH FINE (APPRECIABLE AMOUNT OF FINES)		SM	SILTY SANDS, SAND-SILT MIXTURES
					SC	CLAYEY SANDS, SAND-CLAY MIXTURES
	FINE GRAINED SOILS	SILTS AND CLAYS	LIQUID LIMIT LESS THAN 50		ML	INORGANIC SILTS AND VERY FINE SANDS, ROCK FLOUR, SILTY OR CLAYEY FINE SANDS OR CLAYEY SILTS WITH SLIGHT PLASTICITY
					CL	INORGANIC CLAYS OF LOW TO MEDIUM PLASTICITY, GRAVELLY CLAYS, SANDY CLAYS, SILTY CLAYS, LEAN CLAYS
				OL	ORGANIC SILTS AND ORGANIC SILTY CLAYS OF LOW PLASTICITY	
SILTS AND CLAYS		LIQUID LIMIT GREATER THAN 50		MH	INORGANIC SILTS, MICACEOUS OR DIATOMACEOUS FINE SAND OR SILTY SOILS	
				CH	INORGANIC CLAYS OF HIGH PLASTICITY, FAT CLAYS	
				OH	ORGANIC CLAYS OF MEDIUM TO HIGH PLASTICITY, ORGANIC SILTS	
HIGHLY ORGANIC SOILS				PT	PEAT, HUMUS, SWAMP SOILS WITH HIGH ORGANIC CONTENTS	

NOTE: DUAL SYMBOLS ARE USED TO INDICATE BORDERLINE SOIL CLASSIFICATIONS

UNIFIED SOIL CLASSIFICATION SYSTEM

KEY:

- Indicates 2.5-inch Inside Diameter. Ring Sample.
- ☒ Indicates 2-inch OD Split Spoon Sample (SPT).
- ☐ Indicates Shelby Tube Sample.
- Indicates No Recovery.
- ▣ Indicates SPT with 140# Hammer 30 in. Drop.
- ☑ Indicates Bulk Sample.
- ▤ Indicates Small Bag Sample.
- ▢ Indicates Non-Standard
- ☒ Indicates Core Run.

COMPONENT DEFINITIONS

COMPONENT	SIZE RANGE
Boulders	Larger than 12 in
Cobbles	3 in to 12 in
Gravel	3 in to No 4 (4.5mm)
Coarse gravel	3 in to 3/4 in
Fine gravel	3/4 in to No 4 (4.5mm)
Sand	No. 4 (4.5mm) to No. 200 (0.074mm)
Coarse sand	No. 4 (4.5 mm) to No. 10 (2.0 mm)
Medium sand	No. 10 (2.0 mm) to No. 40 (0.42 mm)
Fine sand	No. 40 (0.42 mm) to No. 200 (0.074 mm)
Silt and Clay	Smaller than No. 200 (0.074 mm)

COMPONENT PROPORTIONS

DESCRIPTIVE TERMS	RANGE OF PROPORTION
Trace	1 - 5%
Few	5 - 10%
Little	10 - 20%
Some	20 - 35%
And	35 - 50%

MOISTURE CONTENT

DRY	Absence of moisture, dusty, dry to the touch.
DAMP	Some perceptible moisture; below optimum
MOIST	No visible water; near optimum moisture content
WET	Visible free water, usually soil is below water table.

RELATIVE DENSITY OR CONSISTENCY VERSUS SPT N -VALUE

COHESIONLESS SOILS		COHESIVE SOILS		
Density	N (blows/ft)	Consistency	N (blows/ft)	Approximate Undrained Shear Strength (psf)
Very Loose	0 to 4	Very Soft	0 to 2	< 250
Loose	4 to 10	Soft	2 to 4	250 - 500
Medium Dense	10 to 30	Medium Stiff	4 to 8	500 - 1000
Dense	30 to 50	Stiff	8 to 15	1000 - 2000
Very Dense	over 50	Very Stiff	15 to 30	2000 - 4000
		Hard	over 30	> 4000

Phelan Development Co.
22417-21

Log of Boring B-1

Boring Location: SEC of Seaton and Cajalco, Perris

Date of Drilling: 3/23/21

Groundwater Depth: None Encountered

Drilling Method: Simco 2800HS

Hammer Weight: 140 lbs.

Drop: 30"

Surface Elevation: Not Measured

Depth (feet)	Lithology	Material Description	Samples		Laboratory		
			Type	Blow Counts	Moisture	Dry Density	Fines Content %
0	GWT not encountered	FILL SOILS Sandy SILT Brown, soft, damp					
5		NATURAL SOILS Sandy SILT Brown, stiff, damp to moist slightly clayey	☒	20/22/30	8.7		51
10		Silty SAND Brown, dense, damp	☒	10/10/10	7.5		35
15		Clayey SAND Brown, dense, slightly moist	☒	14/16/16	8.2		49
20				☒	13/14/18	8.2	
25			☒	8/9/18	7.1		42
30		Decomposed Granite SAND, medium to coarse grained Grey brown, dense to very dense, damp, slightly silt	☒	15/20/37	5.1		11

SuperLog CivilTech Software, USA www.civiltech.com File: C:\Superlog4\PROJECT\22417-21.log Date: 4/13/2021

Phelan Development Co.
22417-21

Log of Boring B-1

Boring Location: SEC of Seaton and Cajalco, Perris

Date of Drilling: 3/23/21



Groundwater Depth: None Encountered

Drilling Method: Simco 2800HS

Hammer Weight: 140 lbs.

Drop: 30"

Surface Elevation: Not Measured

Depth (feet)	Lithology	Material Description	Samples		Laboratory		
			Type	Blow Counts	Moisture	Dry Density	Fines Content %
35		Decomposed Granite SAND, medium to coarse grained Grey brown, dense to very dense, damp, slightly silt Boring completed at depth of 35.5' Refusal at 35.5'		50-3"	4.3		14
40							
45							
50							
55							
60							
65							
70							

NorCal Engineering

Phelan Development Co.
22417-21

Log of Boring B-2

Boring Location: SEC of Seaton and Cajalco, Perris

Date of Drilling: 3/23/21

Groundwater Depth: None Encountered

Drilling Method: Hand Auger

Hammer Weight:

Drop:

Surface Elevation: Not Measured

Depth (feet)	Lithology	Material Description	Samples		Laboratory		
			Type	Blow Counts	Moisture	Dry Density	Fines Content %
0	FILL SOILS Sandy SILT Brown, soft, moist	NATURAL SOILS Sandy SILT Brown, stiff, damp					
5							
		Clayey SAND Brown, dense, moist	■		7.6	106.3	
		Silty SAND Brown, dense, damp to moist	■		5.4	110.1	
10			■		7.5	106.4	
15			■		7.9	112.3	
20		Boring completed at depth of 20'					
25							
30							
35							

NorCal Engineering

Phelan Development Co.
22417-21

Log of Boring B-3

Boring Location: SEC of Seaton and Cajalco, Perris

Date of Drilling: 3/23/21

Groundwater Depth: None Encountered

Drilling Method: Hand Auger

Hammer Weight:

Drop:

Surface Elevation: Not Measured

Depth (feet)	Lithology	Material Description	Samples		Laboratory	
			Type	Blow Counts	Moisture	Dry Density
0	GWT not encountered	FILL SOILS Sandy SILT Brown, soft, moist				
5		NATURAL SOILS Sandy SILT Brown, stiff, damp	■		6.6	111.3
		Clayey SAND Brown, dense, moist	■		5.2	107.7
10		Silty SAND Brown, dense, damp to moist				
		Boring completed at depth of 10'	■		8.3	115.7

NorCal Engineering

Phelan Development Co.
22417-21

Log of Boring B-4

Boring Location: SEC of Seaton and Cajalco, Perris

Date of Drilling: 3/23/21

Groundwater Depth: None Encountered

Drilling Method: Hand Auger

Hammer Weight:

Drop:

Surface Elevation: Not Measured

Depth (feet)	Lithology	Material Description	Samples		Laboratory		
			Type	Blow Counts	Moisture	Dry Density	Fines Content %
0		FILL SOILS Sandy SILT Brown, soft, moist					
		NATURAL SOILS Sandy SILT Brown, stiff, damp	■		2.8	110.6	
		Clayey SAND Brown, dense, moist	■		9.7	114.2	
		Silty SAND Brown, dense, damp to moist					
10		Boring completed at depth of 10'					

NorCal Engineering

Phelan Development Co.
22417-21

Log of Boring B-5

Boring Location: SEC of Seaton and Cajalco, Perris

Date of Drilling: 3/23/21

Groundwater Depth: None Encountered

Drilling Method: Hand Auger

Hammer Weight:

Drop:

Surface Elevation: Not Measured

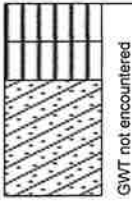
Depth (feet)	Lithology	Material Description	Samples		Laboratory		
			Type	Blow Counts	Moisture	Dry Density	Fines Content %
0		FILL SOILS Sandy SILT Brown, soft, moist	■		8.3	117.3	
		NATURAL SOILS Sandy SILT Brown, stiff, moist					
5	Clayey SAND Brown, dense, moist						
	Boring completed at depth of 5'						
10							
15							
20							
25							
30							
35							

NorCal Engineering

Phelan Development Co.
22417-21

Log of Trench T-1

Boring Location: SEC of Seaton and Cajalco, Perris

Date of Drilling: 3/23/21



Groundwater Depth: None Encountered

Drilling Method: Hand Auger

Hammer Weight:

Drop:

Surface Elevation: Not Measured

Depth (feet)	Lith-ology	Material Description	Samples		Laboratory	
			Type	Blow Counts	Moisture	Dry Density
0		FILL SOILS				
		Sandy CLAY Brown, soft, moist				
		NATURAL SOILS				
		Sandy CLAY Brown, dense, damp to moist				
5		Silty SAND				
		Brown, dense, moist Boring completed at depth of 5'				
10						
15						
20						
25						
30						
35						

NorCal Engineering

Phelan Development Co.
22417-21

Log of Trench T-2

Boring Location: SEC of Seaton and Cajalco, Perris

Date of Drilling: 3/23/21

Groundwater Depth: None Encountered

Drilling Method: Hand Auger

Hammer Weight:

Drop:

Surface Elevation: Not Measured

Depth (feet)	Lithology	Material Description	Samples		Laboratory				
			Type	Blow Counts	Moisture	Dry Density	Fines Content %		
0		FILL SOILS Sandy SILT Brown, soft, moist							
5		NATURAL SOILS Sandy SILT Brown, stiff, damp Sandy CLAY Brown, dense, moist							
10		Boring completed at depth of 10'							
15									
20									
25									
30									
35									



Boring completed at depth of 10'

NorCal Engineering

**Phelan Development Co.
22417-21**

Log of Trench T-3

Boring Location: SEC of Seaton and Cajalco, Perris

Date of Drilling: 3/23/21

Groundwater Depth: None Encountered

Drilling Method: Hand Auger

Hammer Weight:

Drop:

Surface Elevation: Not Measured

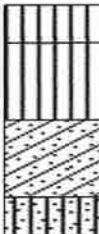
Depth (feet)	Lithology	Material Description	Samples		Laboratory		
			Type	Blow Counts	Moisture	Dry Density	Fines Content %
0		FILL SOILS					
		Sandy SILT					
		Brown, soft, moist					
		NATURAL SOILS					
		Sandy SILT					
5		Brown, stiff, damp					
		Clayey SAND					
		Brown, dense, moist					
		Silty SAND					
		Brown, dense, damp to moist					
	Boring completed at depth of 6'						
10							
15							
20							
25							
30							
35							

SuperLog CivilTech Software, USA www.civiltech.com File: C:\Superlog\PROJECT\22417-21.log Date: 4/13/2021

Boring Location: SEC of Seaton and Cajalco, Perris

Date of Drilling: 3/23/21

Groundwater Depth: None Encountered

Drilling Method: Hand Auger

Hammer Weight:

Drop:

Surface Elevation: Not Measured

Depth (feet)	Lithology	Material Description	Samples		Laboratory		
			Type	Blow Counts	Moisture	Dry Density	Fines Content %
0		FILL SOILS					
		Sandy SILT Brown, soft, moist					
5		NATURAL SOILS Sandy SILT Brown, stiff, damp Boring completed at depth of 5'					
10							
15							
20							
25							
30							
35							

**Phelan Development Co.
22417-21**

Log of Trench T-5

Boring Location: SEC of Seaton and Cajalco, Perris

Date of Drilling: 3/23/21

Groundwater Depth: None Encountered

Drilling Method: Hand Auger

Hammer Weight:

Drop:

Surface Elevation: Not Measured

Depth (feet)	Lith-ology	Material Description	Samples		Laboratory		
			Type	Blow Counts	Moisture	Dry Density	Fines Content %
0		FILL SOILS Sandy SILT Brown, soft, moist					
5		NATURAL SOILS Sandy SILT Brown, stiff, damp Sandy CLAY Brown, stiff, moist	■		6.8	115.9	
10		Clayey SAND Brown, dense, damp to moist	■		8.0	115.8	
15		Boring completed at depth of 15'	■		9.8	117.7	

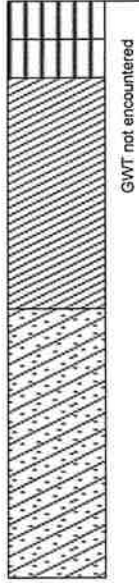

Boring Location: SEC of Seaton and Cajalco, Perris	
Date of Drilling: 3/23/21	Groundwater Depth: None Encountered
Drilling Method: Hand Auger	
Hammer Weight:	Drop:
Surface Elevation: Not Measured	

Depth (feet)	Lithology	Material Description	Samples		Laboratory		
			Type	Blow Counts	Moisture	Dry Density	Fines Content %
0	GWT not encountered	FILL SOILS Sandy CLAY Brown, soft, moist					
5		NATURAL SOILS Sandy CLAY Brown, stiff, damp to moist	■		6.9	106.7	
10		Clayey SAND Brown, dense, damp to moist	■		4.1	108.3	
15			■		10.1	114.6	
		Boring completed at depth of 15'					

SuperLog CivilTech Software, USA www.civiltech.com File: C:\Superlog\PROJECT\22417-21.log Date: 4/14/2021

Boring Location: SEC of Seaton and Cajalco, Perris

Date of Drilling: 3/23/21

Groundwater Depth: None Encountered

Drilling Method: Hand Auger

Hammer Weight:

Drop:

Surface Elevation: Not Measured

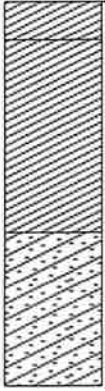
Depth (feet)	Lithology	Material Description	Samples		Laboratory		
			Type	Blow Counts	Moisture	Dry Density	Fines Content %
0		FILL SOILS Sandy CLAY Brown, soft, moist	■		8.6	117.2	
5		NATURAL SOILS Sandy CLAY Brown, stiff, damp to moist					
10		Clayey SAND Brown, dense, moist	■		10.3	112.3	
		Boring completed at depth of 10'					
15							
20							
25							
30							
35							

Boring Location: SEC of Seaton and Cajalco, Perris

Date of Drilling: 3/23/21

Groundwater Depth: None Encountered

Drilling Method: Hand Auger

Hammer Weight:

Drop:

Surface Elevation: Not Measured

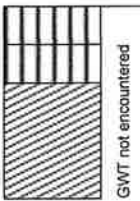
Depth (feet)	Lith-ology	Material Description	Samples		Laboratory		
			Type	Blow Counts	Moisture	Dry Density	Fines Content %
0		FILL SOILS					
		Sandy SILT					
		Brown, soft, moist					
		NATURAL SOILS					
		Sandy SILT		■		3.6	110.8
5		Brown, stiff, damp					
		Sandy CLAY					
	Brown, stiff, moist						
	Boring completed at depth of 5'						
10							
15							
20							
25							
30							
35							

Phelan Development Co.
22417-21

Log of Trench T-9

Boring Location: SEC of Seaton and Cajalco, Perris	
Date of Drilling: 3/23/21	Groundwater Depth: None Encountered
Drilling Method: Hand Auger	
Hammer Weight:	Drop:
Surface Elevation: Not Measured	

Depth (feet)	Lithology	Material Description	Samples		Laboratory		
			Type	Blow Counts	Moisture	DY Density	Fines Content %
0		FILL SOILS Sandy SILT Brown, soft, moist	■		6.5	115.6	
5		NATURAL SOILS Sandy SILT Brown, stiff, damp	■		8.9	112.3	
10		Clayey SAND Brown, dense, moist Silty SAND Brown, dense, damp to moist Slightly clayey	■		8.3	114.5	
		Boring completed at depth of 10'					

SuperLog CivilTech Software, USA www.civiltech.com File: C:\Superlog\PROJECT\22417-21.log Date: 4/14/2021

Appendix B Laboratory Tests

TABLE I
MAXIMUM DENSITY TESTS

Sample	Classification	Optimum Moisture (%)	Maximum Dry Density (lbs/cu.ft)
B-2 @ 2'	Sandy SILT	12.5	118.0
T-5 @ 2'	Sandy CLAY	15.0	122.0
T-9 @ 2'	Clayey SAND	11.5	126.0

TABLE II
EXPANSION TESTS

Sample	Classification	Expansion Index
B-2 @ 2'	Sandy SILT	25
T-5 @ 2'	Sandy CLAY	74
T-9 @ 2'	Clayey SAND	15

TABLE III
ATTERBERG LIMITS

Sample	Liquid Limit	Plastic Limit	Plasticity Index
T-5 @ 5'	35	23	12
T-5 @ 10	25	19	6

TABLE IV
CORROSION TESTS

Sample	pH	Electrical Resistivity	Sulfate (%)	Chloride (ppm)
B-2 @ 2'	6.9	2,190	0.007	290
T-5 @ 2'	6.8	1,765	0.002	239
T-9 @ 2'	6.9	2,570	0.002	190

% by weight
ppm – mg/kg



R-VALUE TEST REPORT

CT-301 ASTM-D2844

PROJECT NAME:	Norcal Phelan Development Company 22417-21	PROJECT NUMBER:	L-210301
SAMPLE LOCATION:	SEC of Seaton Ave and Cajalco Rd, Perris, CA	SAMPLE NUMBER:	T-1
SAMPLE DESCRIPTION:	SANDY CLAY (CL), brown	SAMPLE DEPTH:	2'
SAMPLED BY:	Norcal JS 3/24/21	TESTED BY:	ER
		DATE TESTED:	3/29/2021

TEST SPECIMEN	A	B	C
MOISTURE AT COMPACTION %	15.1	13.5	12.4
WEIGHT OF SAMPLE, grams	1146	1137	1094
HEIGHT OF SAMPLE, Inches	2.63	2.55	2.40
DRY DENSITY, pcf	114.7	119.1	122.9
COMPACTOR AIR PRESSURE, psi	90	120	150
EXUDATION PRESSURE, psi	213	341	404
EXPANSION, Inches x 10exp-4	0	0	20
STABILITY Ph 2,000 lbs (160 psi)	144	133	118
TURNS DISPLACEMENT	6.16	5.60	4.72
R-VALUE UNCORRECTED	4	8	16
R-VALUE CORRECTED	5	8	14
EXPANSION PRESSURE (psf)	0.0	0.0	86.4

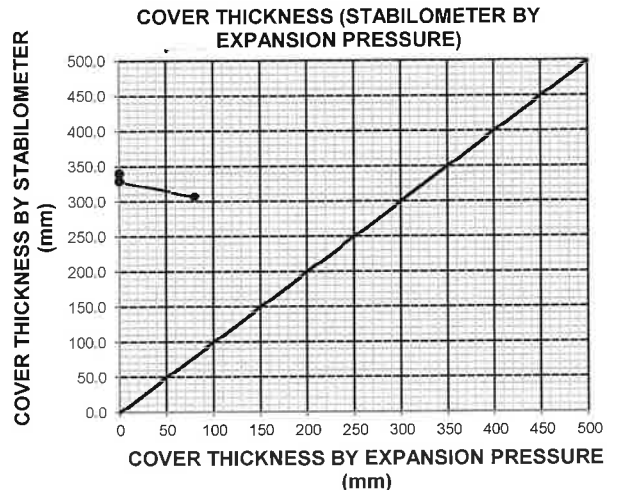
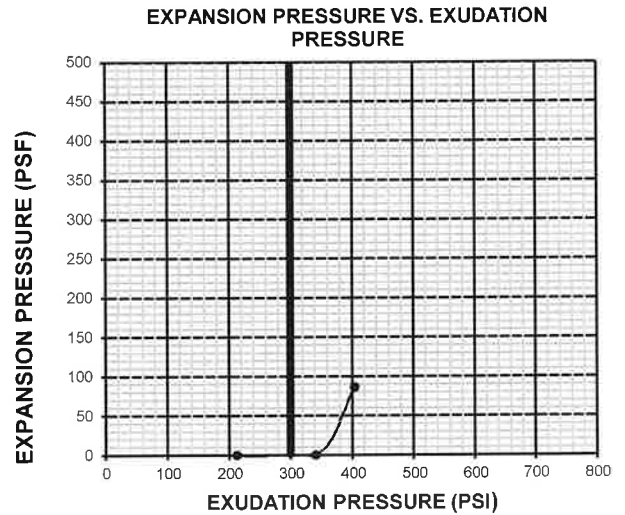
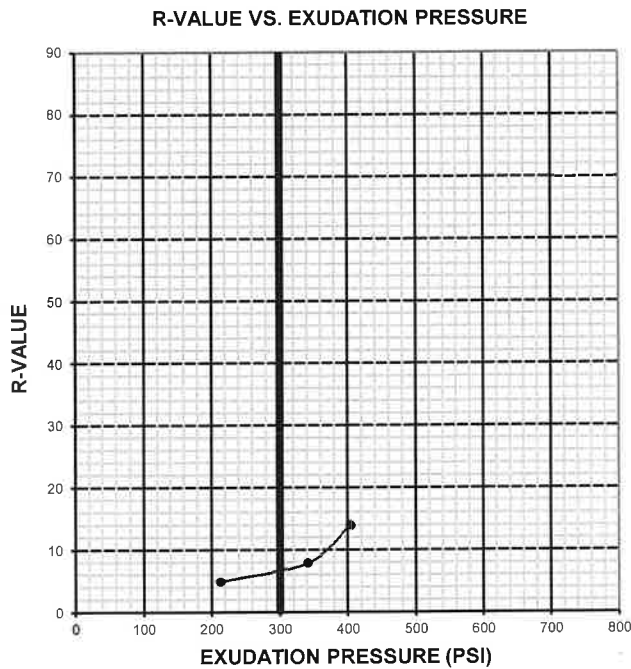

R-VALUE AT EQUILIBRIUM: 7

R-VALUE BY EXUDATION PRESSURE:	7
R-VALUE BY EXPANSION PRESSURE:	N.A.
EXPANSION PRESSURE AT 300 PSI EXUDATION:	0
TRAFFIC INDEX (Assumed):	5.5
GRAVEL FACTOR (Assumed):	1.5
UNIT MASS OF COVER MATERIAL, kg/m ³ (Assumed):	2100.0

Sample No. B4@3'
 Sample Type: Undisturbed-Saturated
 Soil Description: Sandy Silt

		1	2	3
Normal Stress	(psf)	1000	2000	3000
Peak Stress	(psf)	780	1404	2040
Displacement	(in.)	0.080	0.100	0.100
Residual Stress	(psf)	684	1344	1872
Displacement	(in.)	0.250	0.250	0.250
Initial Dry Density	(pcf)	110.6	110.6	110.6
Initial Water Content	(%)	2.8	2.8	2.8
Strain Rate	(in./min.)	0.020	0.020	0.020

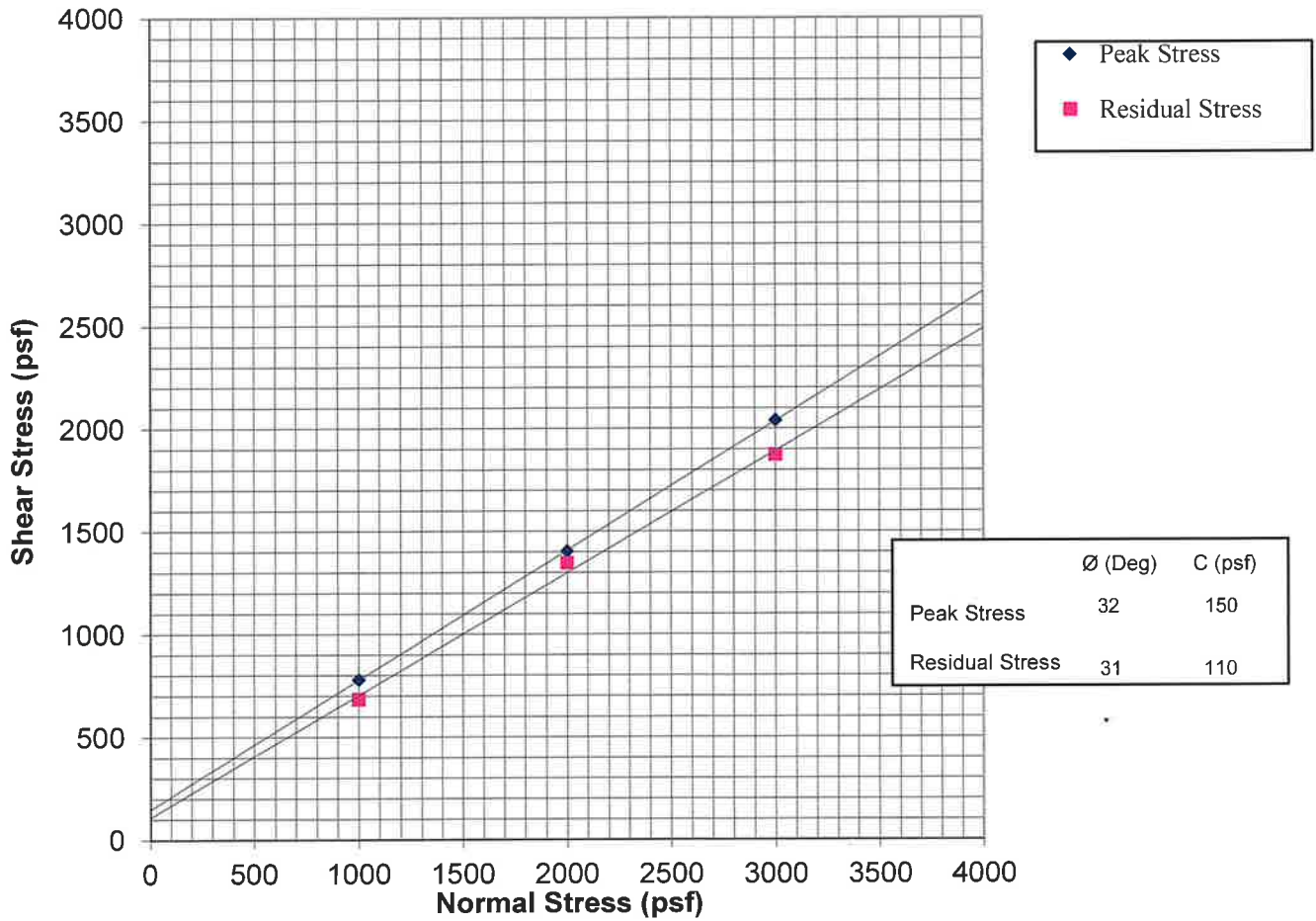
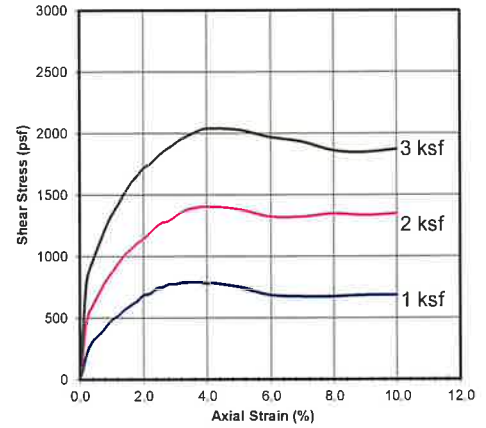

NorCal Engineering
 SOILS AND GEOTECHNICAL CONSULTANTS

Phelan Development Company

PROJECT NUMBER: 22417-21

DATE: 4/12/2021

DIRECT SHEAR TEST
 ASTM D3080

Plate A

Sample No. T5@2'
 Sample Type: Undisturbed-Saturated
 Soil Description: Sandy Clay

		1	2	3
Normal Stress	(psf)	1000	2000	3000
Peak Stress	(psf)	720	1272	1680
Displacement	(in.)	0.070	0.225	0.225
Residual Stress	(psf)	720	1272	1680
Displacement	(in.)	0.250	0.250	0.250
Initial Dry Density	(pcf)	115.9	115.9	115.9
Initial Water Content	(%)	6.8	6.8	6.8
Strain Rate	(in./min.)	0.020	0.020	0.020

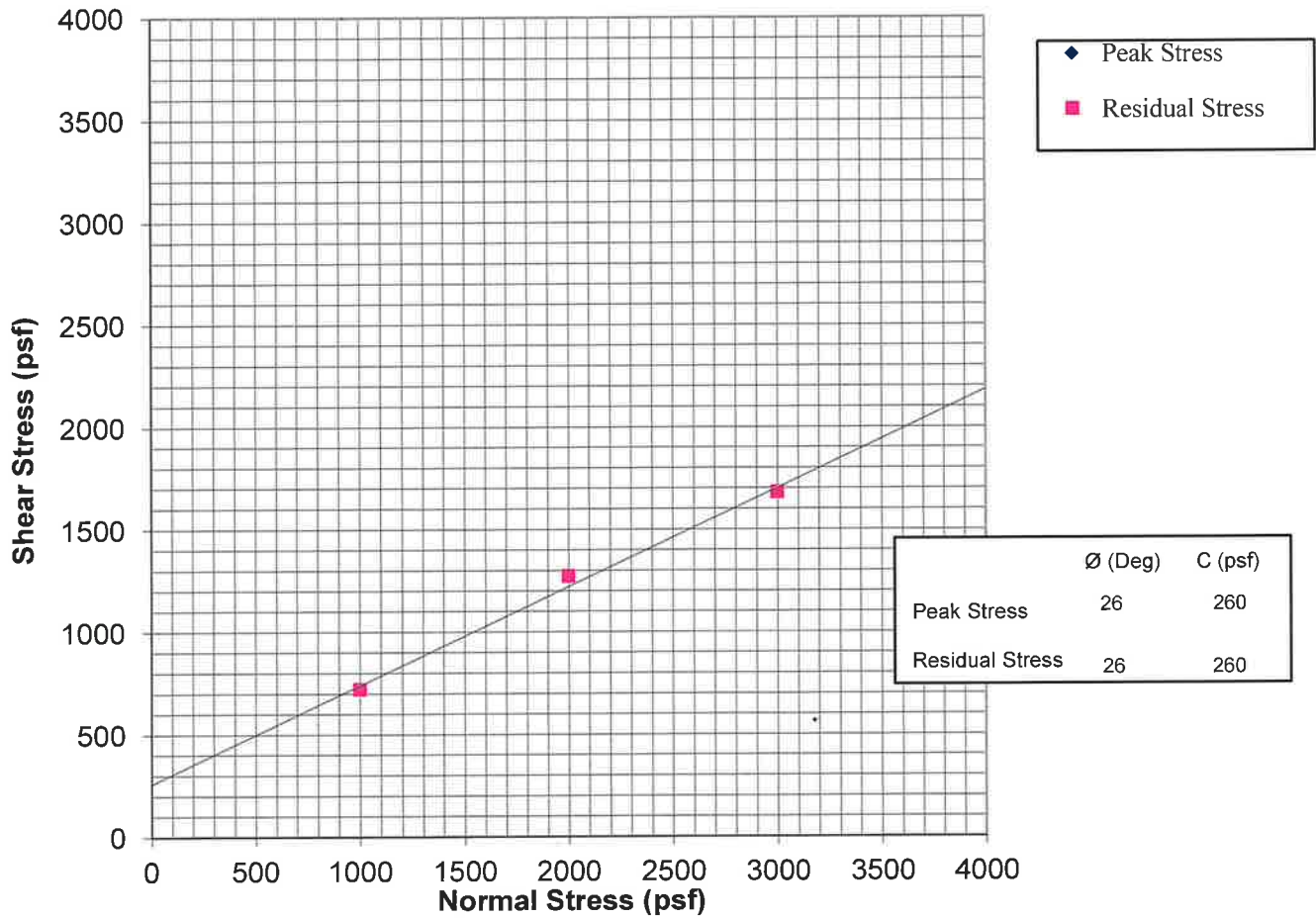
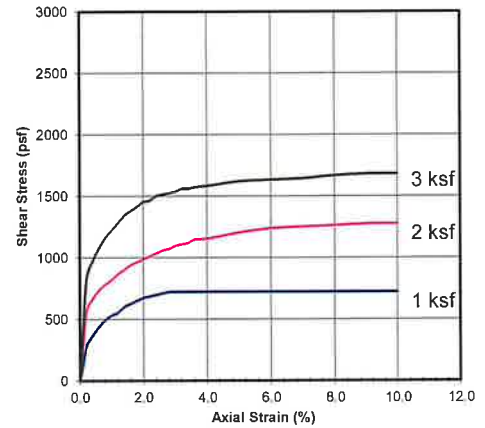

NorCal Engineering
 SOILS AND GEOTECHNICAL CONSULTANTS

Phelan Development Company

PROJECT NUMBER: 22417-21

DATE: 4/12/2021

DIRECT SHEAR TEST
ASTM D3080

Plate B

Vertical Pressure (kips/sq.ft.)	Sample Height (inches)	Consolidation (percent)	Sample No. B2	Depth 8'	Date 4/12/2021
------------------------------------	---------------------------	----------------------------	---------------	----------	----------------

0.125	1.0000	0.0
0.25	0.9990	0.1
0.5	0.9980	0.2
1	0.9960	0.4
1	0.9910	0.9
2	0.9845	1.6
4	0.9770	2.3
8	0.9670	3.3
0.25	0.9735	2.7

Saturated

Date Tested: 4/8/2021
Sample: B2
Depth: 8'

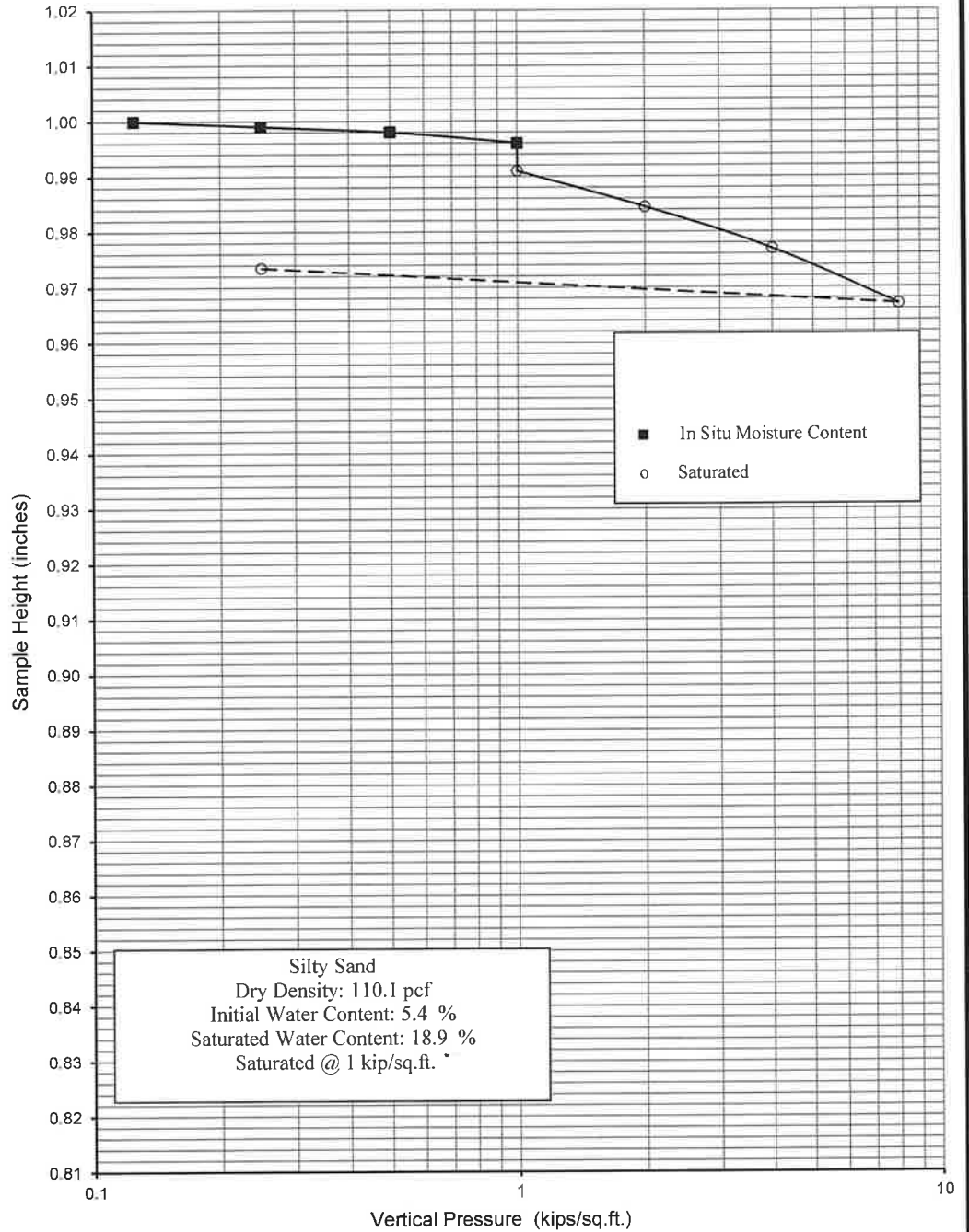

NorCal Engineering

SOILS AND GEOTECHNICAL CONSULTANTS

Phelan Development Company

PROJECT NUMBER: 22417-21

DATE: 4/12/2021

CONSOLIDATION TEST

ASTM D2435

Plate C

Vertical Pressure (kips/sq.ft.)	Sample Height (inches)	Consolidation (percent)	Sample No. T5	Depth 5'	Date 4/12/2021
---------------------------------	------------------------	-------------------------	---------------	----------	----------------

0.125	1.0000	0.0
0.25	0.9985	0.2
0.5	0.9970	0.3
1	0.9950	0.5
1	0.9970	0.3
2	0.9945	0.6
4	0.9895	1.1
8	0.9810	1.9
0.25	0.9935	0.6

Saturated

Date Tested: 4/9/2021
Sample: T5
Depth: 5'

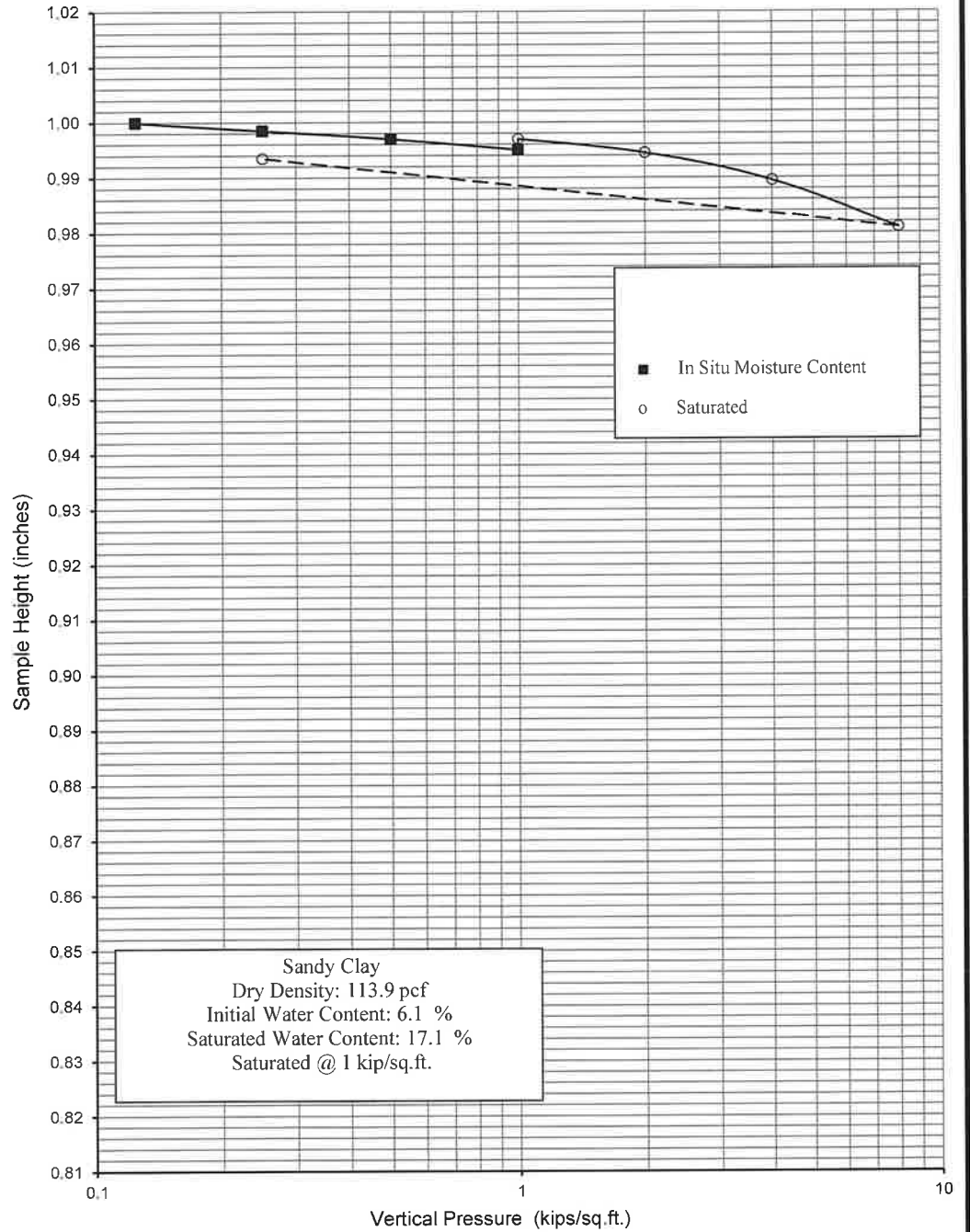

NorCal Engineering
SOILS AND GEOTECHNICAL CONSULTANTS
Phelan Development Company
PROJECT NUMBER: 22417-21 DATE: 4/12/2021

CONSOLIDATION TEST
ASTM D2435
Plate D

Vertical Pressure (kips/sq.ft.)	Sample Height (inches)	Consolidation (percent)	Sample No. T5	Depth 10'	Date 4/12/2021
------------------------------------	---------------------------	----------------------------	---------------	-----------	----------------

0.125	1.0000	0.0
0.25	0.9990	0.1
0.5	0.9980	0.2
1	0.9965	0.4
1	0.9960	0.4
2	0.9925	0.8
4	0.9875	1.3
8	0.9780	2.2
0.25	0.9855	1.5

Saturated

Date Tested: 4/9/2021
Sample: T5
Depth: 10'

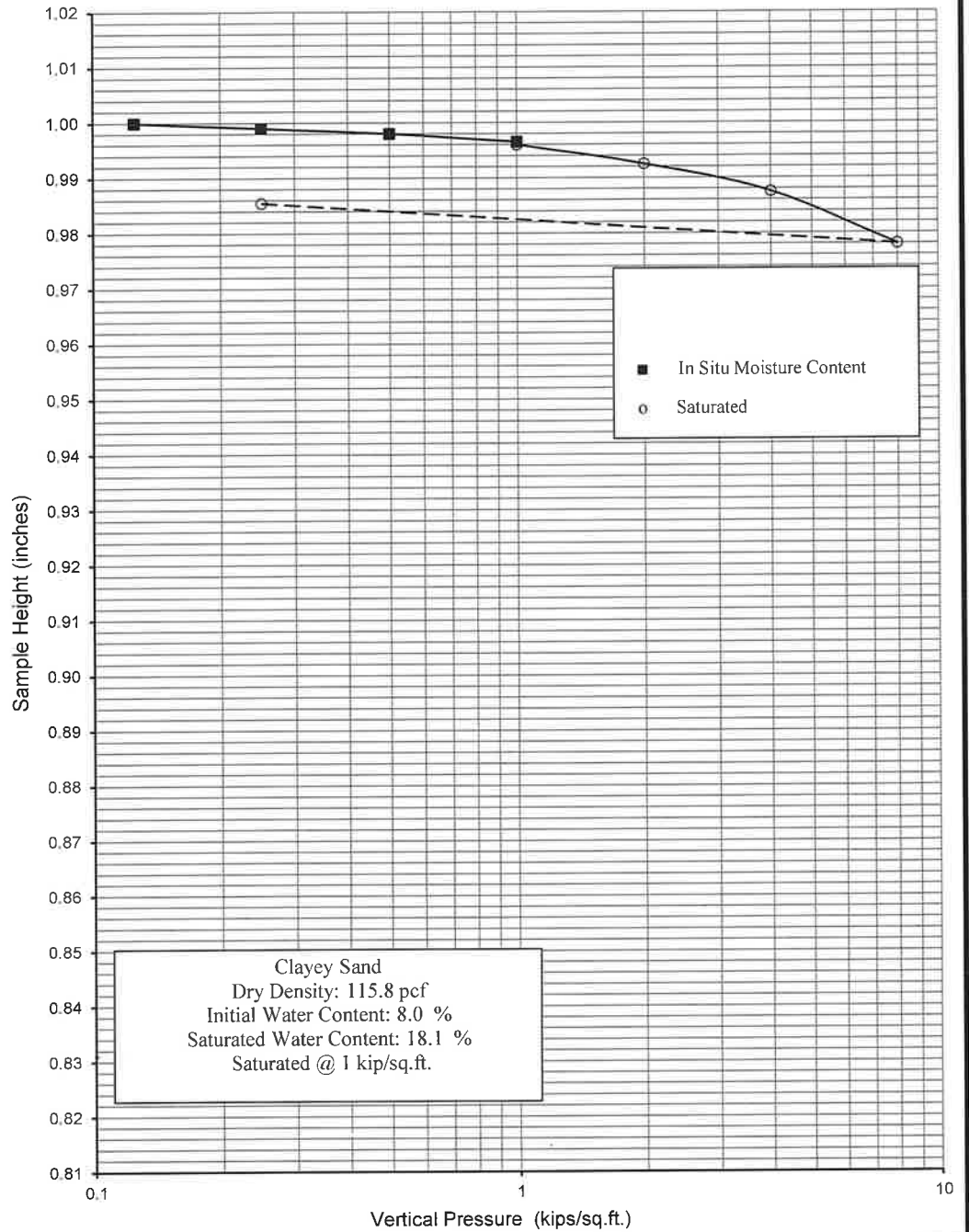

NorCal Engineering

SOILS AND GEOTECHNICAL CONSULTANTS

Phelan Development Company

PROJECT NUMBER: 22417-21

DATE: 4/12/2021

CONSOLIDATION TEST

ASTM D2435

Plate E

Appendix C

Seismic Design Report

ASCE 7 Hazards Report

Address:
No Address at This
Location

Standard: ASCE/SEI 7-16
Risk Category: II
Soil Class: D - Stiff Soil

Elevation: 1558.42 ft (NAVD 88)
Latitude: 33.835842
Longitude: -117.26078

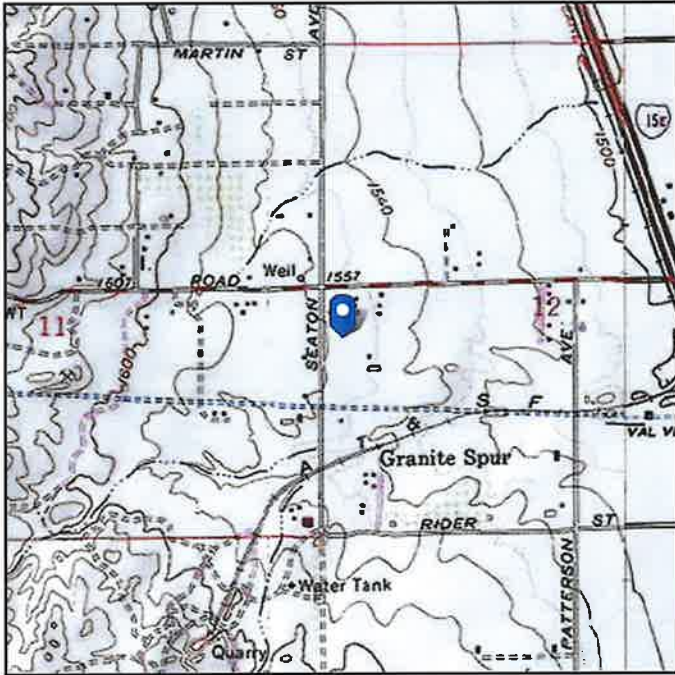

Seismic

Site Soil Class: D - Stiff Soil

Results:

S_s :	1.5	S_{D1} :	N/A
S_1 :	0.557	T_L :	8
F_a :	1	PGA :	0.5
F_v :	N/A	PGA _M :	0.55
S_{MS} :	1.5	F_{PGA} :	1.1
S_{M1} :	N/A	I_e :	1
S_{DS} :	1	C_v :	1.4

Ground motion hazard analysis may be required. See ASCE/SEI 7-16 Section 11.4.8.

Data Accessed: Wed Mar 31 2021

Date Source: [USGS Seismic Design Maps](#)

The ASCE 7 Hazard Tool is provided for your convenience, for informational purposes only, and is provided "as is" and without warranties of any kind. The location data included herein has been obtained from information developed, produced, and maintained by third party providers; or has been extrapolated from maps incorporated in the ASCE 7 standard. While ASCE has made every effort to use data obtained from reliable sources or methodologies, ASCE does not make any representations or warranties as to the accuracy, completeness, reliability, currency, or quality of any data provided herein. Any third-party links provided by this Tool should not be construed as an endorsement, affiliation, relationship, or sponsorship of such third-party content by or from ASCE.

ASCE does not intend, nor should anyone interpret, the results provided by this Tool to replace the sound judgment of a competent professional, having knowledge and experience in the appropriate field(s) of practice, nor to substitute for the standard of care required of such professionals in interpreting and applying the contents of this Tool or the ASCE 7 standard.

In using this Tool, you expressly assume all risks associated with your use. Under no circumstances shall ASCE or its officers, directors, employees, members, affiliates, or agents be liable to you or any other person for any direct, indirect, special, incidental, or consequential damages arising from or related to your use of, or reliance on, the Tool or any information obtained therein. To the fullest extent permitted by law, you agree to release and hold harmless ASCE from any and all liability of any nature arising out of or resulting from any use of data provided by the ASCE 7 Hazard Tool.

Appendix D

Soil Infiltration Data



SOILS AND GEOTECHNICAL CONSULTANTS

Project: Phelan Development Company
Project No.: 22417-21
Date: 3/24/2021
Test No. 1
Depth: 5'
Tested By: J.O.

TIME (hr/min)	CHANGE TIME (min)	CUMULATIVE TIME (min)	INNER RING READING (cm)	INNER RING CHANGE	INNER RING FLOW (cc)	OUTER RING READING (cm)	OUTER RING CHANGE	OUTER RING FLOW (cc)	INNER RING INF RATE (cm/hr)	OUTER RING INF RATE (cm/hr)	INNER RING INF RATE (ft/hr)
7:33			128.6			39.4					
7:38	5	5	133.9	5.3		45.0	5.6				
7:38			128.1			42.2					
7:43	5	10	133.4	5.3		48.2	6.0				
7:43			128.6			42.9					
7:48	5	15	133.2	4.6		47.7	4.8				
7:48			127.1			43.1					
7:53	5	20	131.9	4.8		47.3	4.2				
7:53			128.4			41.5					
7:58	5	25	132.3	3.9		47.9	6.4				
7:58			127.7			39.7					
8:03	5	30	131.7	4.0		44.6	4.9				
8:03			128.3			40.2					
8:08	5	35	132.1	3.8		45.0	4.8		45.6	57.6	
8:08			128.8			39.6					
8:13	5	40	132.6	3.8		44.4	4.8		45.6	57.6	
8:13			128.4			39.4					
8:18	5	45	132.1	3.7		43.7	4.3		44.4	51.6	
8:18			126.8			39.3					
8:23	5	50	131.1	4.3		43.4	4.1		51.6	49.2	
8:23			131.8			43.4					
8:28	5	55	135.7	3.9		47.7	4.3		46.8	51.6	
8:28			128.8			39.5					
8:33	5	60	132.8	4.0		43.7	4.2		48.0	50.4	

Average = 47.0 / 53.0 cm/hr



SOILS AND GEOTECHNICAL CONSULTANTS

Project: Phelan Development Company
Project No.: 22417-21
Date: 3/24/2021
Test No. 2
Depth: 10'
Tested By: J.C.

TIME (hr/min)	CHANGE TIME (min)	CUMULATIVE TIME (min)	INNER RING READING (cm)	INNER RING CHANGE	INNER RING FLOW (cc)	OUTER RING READING (cm)	OUTER RING CHANGE	OUTER RING FLOW (cc)	INNER RING INF RATE (cm/hr)	OUTER RING INF RATE (cm/hr)	INNER RING INF RATE (ft/hr)
9:38			128.5			39.5					
9:48	10	10	129.0	0.5		40.0	0.5				
9:48			129.0			40.0					
9:58	10	20	129.0	0.0		40.0	0.0				
9:58			129.0			40.0					
10:08	10	30	129.0	0.0		40.0	0.0				
10:08			129.0			40.0					
10:18	10	40	129.0	0.0		40.0	0.0				
10:18			129.0			40.0					
10:28	10	50	129.0	0.5		40.0	0.0				
10:28			129.5			40.0					
10:38	10	60	129.5	0.0		40.0	0.0				
10:38			129.5			40.0					
10:48	10	70	129.5	0.0		40.0	0.0		0.0	0.0	
10:48			129.5			40.0					
10:58	10	80	129.5	0.0		40.0	0.0		0.0	0.0	
10:58			129.5			40.0					
11:08	10	90	129.5	0.5		40.3	0.3		3.0	1.8	
11:08			130.0			40.3					
11:18	10	100	130.0	0.0		40.5	0.2		0.0	1.2	
11:18			130.0			40.5					
11:28	10	110	130.0	0.0		40.5	0.0		0.0	0.0	
11:28			130.0			40.5					
11:38	10	120	130.0	0.0		40.5	0.0		0.0	0.0	

Average = 0.5 / 0.5 cm/hr



SOILS AND GEOTECHNICAL CONSULTANTS

Project: Phelan Development Company
Project No.: 22417-21
Date: 3/24/2021
Test No. 3
Depth: 6'
Tested By: J.O.

TIME (hr/min)	CHANGE TIME (min)	CUMULATIVE TIME (min)	INNER RING READING (cm)	INNER RING CHANGE	INNER RING FLOW (cc)	OUTER RING READING (cm)	OUTER RING CHANGE	OUTER RING FLOW (cc)	INNER RING INF RATE (cm/hr)	OUTER RING INF RATE (cm/hr)	INNER RING INF RATE (ft/hr)
9:58			100.2			38.1					
10:03	5	5	109.7	9.5		47.8	9.7				
10:03			98.6			37.6					
10:08	5	10	107.9	9.3		45.2	7.6				
10:08			100.1			38.2					
10:13	5	15	106.6	6.5		43.8	5.6				
10:13			100.4			38.8					
10:18	5	20	106.5	6.1		43.4	4.6				
10:18			99.4			39.6					
10:23	5	25	105.6	6.2		44.9	5.3				
10:23			97.6			37.9					
10:28	5	30	103.3	5.7		42.3	4.4				
10:28			98.5			37.6					
10:33	5	35	103.6	5.1		41.6	4.6		61.2	55.2	
10:33			98.1			37.0					
10:38	5	40	102.7	4.6		41.5	4.5		55.2	54.0	
10:38			97.1			37.0					
10:43	5	45	101.3	4.2		41.1	4.1		50.4	49.2	
10:43			98.5			37.0					
10:48	5	50	102.8	4.3		41.3	4.3		51.6	51.6	
10:48			92.0			37.0					
10:53	5	55	101.4	3.4		40.3	3.9		40.8	46.8	
10:53			97.5			36.2					
10:58	5	60	101.1	3.6		40.0	3.8		43.2	45.6	

Average = 50.4 / 50.4 cm/hr



SOILS AND GEOTECHNICAL CONSULTANTS

Project: Phelan Development Company
Project No.: 22417-21
Date: 3/24/2021
Test No. 4
Depth: 5'
Tested By: J.C.

TIME (hr/min)	CHANGE TIME (min)	CUMULATIVE TIME (min)	INNER RING READING (cm)	INNER RING CHANGE	INNER RING FLOW (cc)	OUTER RING READING (cm)	OUTER RING CHANGE	OUTER RING FLOW (cc)	INNER RING INF RATE (cm/hr)	OUTER RING INF RATE (cm/hr)	INNER RING INF RATE (ft/hr)
12:36			130.0			40.1					
12:41	5	5	134.0	4.0		45.0	4.9				
12:41			134.0			45.0					
12:46	5	10	136.5	2.5		47.0	2.0				
12:46			133.0			45.0					
12:51	5	15	134.0	1.0		45.5	0.5				
12:51			134.0			45.5					
12:56	5	20	136.0	2.0		47.4	2.9				
12:56			130.2			45.0					
1:01	5	25	131.9	1.7		47.1	2.1				
1:01			129.8			42.0					
1:06	5	30	132.5	2.7		44.5	2.5				
1:06			132.5			44.5					
1:11	5	35	134.5	2.0		46.5	2.0		24.0	24.0	
1:11			134.5			46.5					
1:16	5	40	135.5	1.0		47.5	1.0		12.0	12.0	
1:16			135.5			47.5					
1:21	5	45	137.0	1.5		48.5	1.0		18.0	12.0	
1:21			133.0			44.5					
1:26	5	50	134.5	1.5		45.5	1.0		18.0	12.0	
1:26			134.5			45.5					
1:31	5	55	136.0	1.5		47.5	2.0		18.0	24.0	
1:31			136.0			47.5					
1:36	5	60	138.0	2.0		48.5	1.0		24.0	12.0	

Average = 19.0 / 16.0 cm/hr

NorCal Engineering
Soils and Geotechnical Consultants
10641 Humbolt Street Los Alamitos, CA 90720
(562) 799-9469 Fax (562) 799-9459

December 7, 2021

Project Number 22417-21

Phelan Development Company
450 Newport Center Drive, Suite 405
Newport Beach, California 92660

Attn.: Ms. Ashley McKinley

RE: **Basin Embankment Recommendation** - Proposed Industrial Warehouse
Development - Located at the Southeast Corner of Seaton Avenue and Cajalco
Road, Perris, in the County of Riverside, California

Dear Ms. McKinley:

Pursuant to your request, this firm has reviewed project plans for the referenced site. This firm reviewed the "Preliminary Grading Plan- Plot Plan No. 210133" by SDA and Associates, Inc. dated September 30, 2021. The proposed infiltration design towards the southeast corner of the property shows a basin embankment height of 5.3 feet. This firm approves the placement of a 6 feet bench width with descending 4 to 1 (horizontal to vertical) engineered fill slopes in the southeast portion of the lot as shown on the referenced plans.

We appreciate this opportunity to be of service to you. If you have any further questions, please do not hesitate to contact the undersigned.

Respectfully submitted,
NORCAL ENGINEERING



Keith D. Tucker
Project Engineer
R.G.E. 841



Scott D. Spensiero
Project Manager

SEE SHEET 3

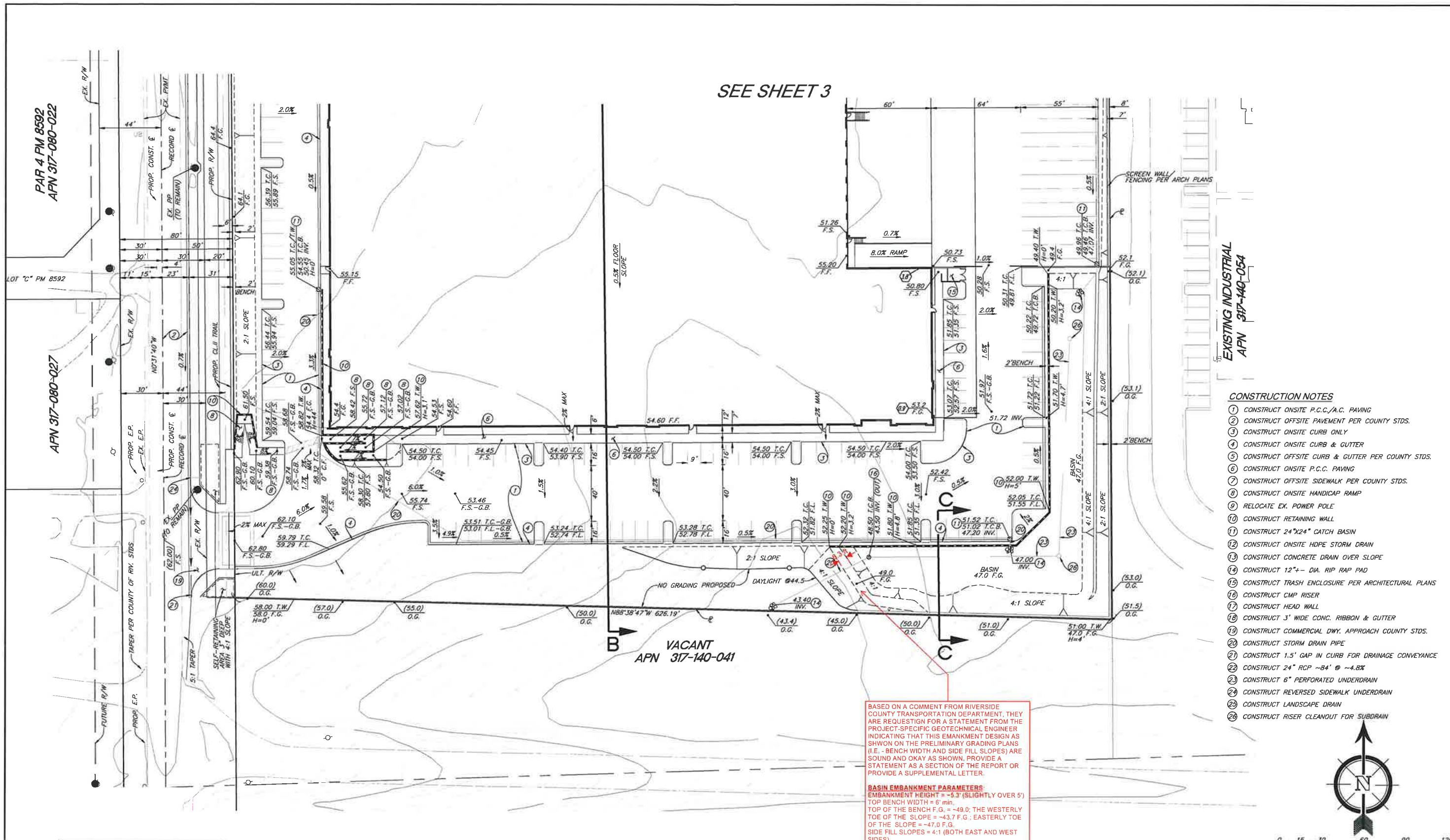

- CONSTRUCTION NOTES**
- 1 CONSTRUCT ONSITE P.C.C./A.C. PAVING
 - 2 CONSTRUCT OFFSITE PAVEMENT PER COUNTY STDS.
 - 3 CONSTRUCT ONSITE CURB ONLY
 - 4 CONSTRUCT ONSITE CURB & GUTTER
 - 5 CONSTRUCT OFFSITE CURB & GUTTER PER COUNTY STDS.
 - 6 CONSTRUCT ONSITE P.C.C. PAVING
 - 7 CONSTRUCT OFFSITE SIDEWALK PER COUNTY STDS.
 - 8 CONSTRUCT ONSITE HANDICAP RAMP
 - 9 RELOCATE EX. POWER POLE
 - 10 CONSTRUCT RETAINING WALL
 - 11 CONSTRUCT 24"x24" CATCH BASIN
 - 12 CONSTRUCT ONSITE HDPE STORM DRAIN
 - 13 CONSTRUCT CONCRETE DRAIN OVER SLOPE
 - 14 CONSTRUCT 12"± DIA. RIP RAP PAD
 - 15 CONSTRUCT TRASH ENCLOSURE PER ARCHITECTURAL PLANS
 - 16 CONSTRUCT CMP RISER
 - 17 CONSTRUCT HEAD WALL
 - 18 CONSTRUCT 3" WIDE CONC. RIBBON & GUTTER
 - 19 CONSTRUCT COMMERCIAL DWY. APPROACH COUNTY STDS.
 - 20 CONSTRUCT STORM DRAIN PIPE
 - 21 CONSTRUCT 1.5' GAP IN CURB FOR DRAINAGE CONVEYANCE
 - 22 CONSTRUCT 24" RCP ~84' @ ~4.8%
 - 23 CONSTRUCT 6" PERFORATED UNDERDRAIN
 - 24 CONSTRUCT REVERSED SIDEWALK UNDERDRAIN
 - 25 CONSTRUCT LANDSCAPE DRAIN
 - 26 CONSTRUCT RISER CLEANOUT FOR SUBRAIN

BASED ON A COMMENT FROM RIVERSIDE COUNTY TRANSPORTATION DEPARTMENT, THEY ARE REQUESTING FOR A STATEMENT FROM THE PROJECT-SPECIFIC GEOTECHNICAL ENGINEER INDICATING THAT THIS EMBANKMENT DESIGN AS SHOWN ON THE PRELIMINARY GRADING PLANS (I.E. - BENCH WIDTH AND SIDE FILL SLOPES) ARE SOUND AND OKAY AS SHOWN, PROVIDE A STATEMENT AS A SECTION OF THE REPORT OR PROVIDE A SUPPLEMENTAL LETTER.

BASIN EMBANKMENT PARAMETERS
 EMBANKMENT HEIGHT = 5.3' (SLIGHTLY OVER 5')
 TOP BENCH WIDTH = 6' min.
 TOP OF THE BENCH F.G. = -49.0; THE WESTERLY TOE OF THE SLOPE = -43.7 F.G.; EASTERLY TOE OF THE SLOPE = -47.0 F.G.
 SIDE FILL SLOPES = 4:1 (BOTH EAST AND WEST SIDES).

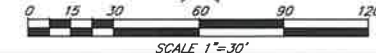

NOTE:
 WORK CONTAINED WITHIN THESE PLANS SHALL NOT COMMENCE UNTIL AN ENCROACHMENT PERMIT AND/OR A GRADING PERMIT HAS BEEN ISSUED.

The private engineer signing these plans is responsible for assuring the accuracy and acceptability of the design hereon. In the event of discrepancies arising after county approval or during construction, the private engineer shall be responsible for determining an acceptable solution and revising the plans for approval by the county.

MARK	BY	DATE	REVISIONS	APPR.	DATE



SEAL - ENGINEER
 ENGINEERING COMPANY
SDH ASSOCIATES
 SDH AND ASSOCIATES INC.
 27383 VIA INDUSTRIAL
 TEMECULA, CA 92590
 TEL: (951) 603-3091 FAX: (951) 788-2314

PREPARED BY: **DANE SOMMERS**
 R.C.E. NO. **90433**
 DATE **9-30-21**

BENCHMARK:
 ELEVATIONS SHOWN HEREON ARE BASED UPON THE N.G.S. BENCHMARK 025442, DESIGNATION "431". THE BENCHMARK IS LOCATED 1300' WEST OF THE JURY RAILROAD ALONG RIVER STREET, ON 125' OF THE NORTH CURB FACE OF RIVER STREET, 20' NORTH OF RIVER STREET, 5' SOUTH OF THE TELEPHONE BOX (EAST) & STANDARD 3 1/4" ALUMINUM BOX SET FLUSH IN TOP OF CURB. ELEVATION 1215.17 FEET (N.A.S.D.).

SCALE: **H: 1"=30'** V: **1"=10'**

PRELIMINARY GRADING PLAN
PLOT PLAN NO. 210133

SHEET NO. **2**
 2 OF 2 SHTS

FOR: **EXISTING INDUSTRIAL APN 317-140-054**

W.O. COUNTY FILE NO.

DRAFT

Appendix 4: Historical Site Conditions

Phase I Environmental Site Assessment or Other Information on Past Site Use

Not included.

Appendix 5: LID Infeasibility

LID Technical Infeasibility Analysis

N/A – Runoff from the project is directed to Canon Lake, which ultimately drains to Lake Elsinore. Based on consideration of “highest and best use” language in Section 2.4.4 of the WQMP guidance document and based on the infiltration rates from the geotechnical infiltration is not technically recommended. Therefore, LID BMPs using bioretention facilities are proposed for this project.

Appendix 6: BMP Design Details

BMP Sizing, Design Details and other Supporting Documentation

Santa Ana Watershed - BMP Design Volume, V_{BMP}

(Rev. 10-2011)

Legend:

Required Entries

Calculated Cells

*(Note this worksheet shall **only** be used in conjunction with BMP designs from the **LID BMP Design Handbook**)*

Company Name **SDH & Associates, Inc.**

Date **1/21/2022**

Designed by **NM**

Case No **PPT210133**

Company Project Number/Name **1916 / Phelan-Seaton**

BMP Identification

BMP NAME / ID **Bioretention Facility / BMP 1**

Must match Name/ID used on BMP Design Calculation Sheet

Design Rainfall Depth

85th Percentile, 24-hour Rainfall Depth,
from the Isohyetal Map in Handbook Appendix E

D₈₅= **0.58** inches

Drainage Management Area Tabulation

Insert additional rows if needed to accommodate all DMAs draining to the BMP

DMA Type/ID	DMA Area (square feet)	Post-Project Surface Type	Effective Imperivous Fraction, I _f	DMA Runoff Factor	DMA Areas x Runoff Factor	Design Storm Depth (in)	Design Capture Volume, V _{BMP} (cubic feet)	Proposed Volume on Plans (cubic feet)
DMA 1-1	41,756	Ornamental Landscaping	0.1	0.11	4612.3			
DMA 1-2	49,154	Concrete or Asphalt	1	0.89	43845.4			
DMA 1-3	296,877	Roofs	1	0.89	264814.3			
	387787				313272	0.58	15141.5	15641

Notes:

Bioretention Facility - Design Procedure		BMP ID 1	Legend:	Required Entries
				Calculated Cells
Company Name:	SDH & Associates, Inc.		Date:	21-Jan
Designed by:	NM		County/City Case No.:	PPT210133
Design Volume				
Enter the area tributary to this feature			$A_T =$	8.9 acres
Enter V_{BMP} determined from Section 2.1 of this Handbook			$V_{BMP} =$	15,142 ft ³
Type of Bioretention Facility Design				
<input checked="" type="radio"/> Side slopes required (parallel to parking spaces or adjacent to walkways) <input type="radio"/> No side slopes required (perpendicular to parking space or Planter Boxes)				
Bioretention Facility Surface Area				
Depth of Soil Filter Media Layer			$d_S =$	2.3 ft
Top Width of Bioretention Facility, excluding curb			$w_T =$	40.0 ft
Total Effective Depth, d_E $d_E = (0.3) \times d_S + (0.4) \times 1 - (0.7/w_T) + 0.5$			$d_E =$	1.56 ft
Minimum Surface Area, A_m $A_M (ft^2) = \frac{V_{BMP} (ft^3)}{d_E (ft)}$			$A_M =$	9,722 ft ²
Proposed Surface Area			$A =$	10,026 ft ²
Bioretention Facility Properties				
Side Slopes in Bioretention Facility			$z =$	4 :1
Diameter of Underdrain				6 inches
Longitudinal Slope of Site (3% maximum)				0.5 %
6" Check Dam Spacing				0 feet
Describe Vegetation:			Other	
Notes: As consistent with the Riverside County LID manual, more than 50% of the interior bioretention facility side slopes will have 4:1 side slope. The remaining portion will have a vertical wall due to the site constraint to fit a 4:1 side slope.				

Santa Ana Watershed - BMP Design Volume, V_{BMP}

(Rev. 10-2011)

Legend:

Required Entries

Calculated Cells

*(Note this worksheet shall **only** be used in conjunction with BMP designs from the **LID BMP Design Handbook**)*

Company Name **SDH & Associates, Inc.**

Date **1/21/2022**

Designed by **NM**

Case No **PPT210133**

Company Project Number/Name **1916 / Phelan-Seaton**

BMP Identification

BMP NAME / ID **Bioretention Facility / BMP 2**

Must match Name/ID used on BMP Design Calculation Sheet

Design Rainfall Depth

85th Percentile, 24-hour Rainfall Depth,
from the Isohyetal Map in Handbook Appendix E

D_{85} = **0.58** inches

Drainage Management Area Tabulation

Insert additional rows if needed to accommodate all DMAs draining to the BMP

DMA Type/ID	DMA Area (square feet)	Post-Project Surface Type	Effective Imperivous Fraction, I_f	DMA Runoff Factor	DMA Areas x Runoff Factor	Design Storm Depth (in)	Design Capture Volume, V_{BMP} (cubic feet)	Proposed Volume on Plans (cubic feet)
DMA 2-1	48,132	Ornamental Landscaping	0.1	0.11	5316.6			
DMA 2-2	201,617	Concrete or Asphalt	1	0.89	179842.4			
DMA 2-3	48,778	Roofs	1	0.89	43510			
Total					228669	0.58	11052.3	11463.2

Notes:

Bioretention Facility - Design Procedure		BMP ID 2	Legend:	Required Entries
				Calculated Cells
Company Name:	SDH & Associates, Inc.		Date:	21-Jan
Designed by:	NM		County/City Case No.:	PPT210133
Design Volume				
Enter the area tributary to this feature			$A_T =$	6.8 acres
Enter V_{BMP} determined from Section 2.1 of this Handbook			$V_{BMP} =$	11,052 ft ³
Type of Bioretention Facility Design				
<input checked="" type="radio"/> Side slopes required (parallel to parking spaces or adjacent to walkways) <input type="radio"/> No side slopes required (perpendicular to parking space or Planter Boxes)				
Bioretention Facility Surface Area				
Depth of Soil Filter Media Layer			$d_S =$	1.8 ft
Top Width of Bioretention Facility, excluding curb			$w_T =$	25.0 ft
Total Effective Depth, d_E $d_E = (0.3) \times d_S + (0.4) \times 1 - (0.7/w_T) + 0.5$			$d_E =$	1.40 ft
Minimum Surface Area, A_m $A_M (ft^2) = \frac{V_{BMP} (ft^3)}{d_E (ft)}$			$A_M =$	7,912 ft ²
Proposed Surface Area			$A =$	8,188 ft ²
Bioretention Facility Properties				
Side Slopes in Bioretention Facility			$z =$	4 :1
Diameter of Underdrain				6 inches
Longitudinal Slope of Site (3% maximum)				0.5 %
6" Check Dam Spacing				0 feet
Describe Vegetation:			Other	
Notes: As consistent with the Riverside County LID manual, more than 50% of the interior bioretention facility side slopes will have 4:1 side slope. The remaining portion will have a vertical wall due to the site constraint to fit a 4:1 side slope.				

Santa Ana Watershed - BMP Design Volume, V_{BMP}

(Rev. 10-2011)

Legend:

Required Entries

Calculated Cells

*(Note this worksheet shall **only** be used in conjunction with BMP designs from the **LID BMP Design Handbook**)*

Company Name **SDH & Associates, Inc.**

Date **9/21/2021**

Designed by **NM**

Case No **PPT210133**

Company Project Number/Name **1916 / Phelan-Seaton**

BMP Identification

BMP NAME / ID **Self-retaining area / SRA OFF-1 (OFFSITE FRONTAGE STREET)**

Must match Name/ID used on BMP Design Calculation Sheet

Design Rainfall Depth

85th Percentile, 24-hour Rainfall Depth,
from the Isohyetal Map in Handbook Appendix E

D_{85} = **0.58** inches

Drainage Management Area Tabulation

Insert additional rows if needed to accommodate all DMAs draining to the BMP

DMA Type/ID	DMA Area (square feet)	Post-Project Surface Type	Effective Imperivous Fraction, I_f	DMA Runoff Factor	DMA Areas x Runoff Factor	Design Storm Depth (in)	Design Capture Volume, V_{BMP} (cubic feet)	Proposed Volume on Plans (cubic feet)
DMA OFF1-1	28450	Ornamental Landscaping	0.1	0.11	3142.5			
DMA OFF1-2	14887	Concrete or Asphalt	1	0.89	13279.2			
DMA OFF1-3	3068	Decomposed Granite	0.4	0.28	858.2			
	46405				17279.9	0.58	835.2	836

Notes:

All of the relevant offsite drainage manage areas are listed on the table above. However, the key DMA is the impervious (concrete or asphalt) portion (DMA OFF1-2). This area will be directed to the proposed "self-retaining area" within the proposed parkway area. The self-retaining area will be depressed approxiamtely 3 inches and consist of 1-foot amended soil underneath to provide the required volume. The effective depth of the SRA will be 0.55 feet. With the footprint shown on the WQMP exhibit should be adequate to provide the required volume.

Santa Ana Watershed - BMP Design Volume, V_{BMP}

(Rev. 10-2011)

Legend:

Required Entries

Calculated Cells

*(Note this worksheet shall **only** be used in conjunction with BMP designs from the **LID BMP Design Handbook**)*

Company Name **SDH & Associates, Inc.**

Date **9/21/2021**

Designed by **NM**

Case No **PPT210133**

Company Project Number/Name **1916 / Phelan-Seaton**

BMP Identification

BMP NAME / ID **Self-retaining area / SRA OFF-2 (OFFSITE FRONTAGE STREET)**

Must match Name/ID used on BMP Design Calculation Sheet

Design Rainfall Depth

85th Percentile, 24-hour Rainfall Depth,
from the Isohyetal Map in Handbook Appendix E

D_{85} = **0.58** inches

Drainage Management Area Tabulation

Insert additional rows if needed to accommodate all DMAs draining to the BMP

DMA Type/ID	DMA Area (square feet)	Post-Project Surface Type	Effective Imperivous Fraction, I_f	DMA Runoff Factor	DMA Areas x Runoff Factor	Design Storm Depth (in)	Design Capture Volume, V_{BMP} (cubic feet)	Proposed Volume on Plans (cubic feet)
DMA OFF2-1	5801	Ornamental Landscaping	0.1	0.11	640.8			
DMA OFF2-2	4501	Concrete or Asphalt	1	0.89	4014.9			
DMA OFF2-3	2727	Decomposed Granite	0.4	0.28	762.8			
	13029		Total		5418.5	0.58	261.9	330

Notes:

All of the relevant offsite drainage manage areas are listed on the table above. However, the key DMA is the impervious (concrete or asphalt) portion (DMA OFF2-2). This area will be directed to the proposed "self-retaining area" within the proposed parkway area. The self-retaining area will be depressed approxiamtely 3 inches and consist of 1-foot amended soil underneath to provide the required volume. The effective depth of the SRA will be 0.55 feet. With the footprint shown on the WQMP exhibit should be adequate to provide the required volume.

Appendix 7: Hydromodification

Supporting Detail Relating to Hydrologic Conditions of Concern

Note: The project is within the Riverside County WAP HCOC Exemption area approved on April 20, 2017. Therefore, the project is exempt from the HCOC requirements.

SCREEN CAPTURE - RIVERSIDE COUNTY STORM
WATER & WATER CONSERVATION TRACKING TOOL
HCOC EXEMPTION AREAS

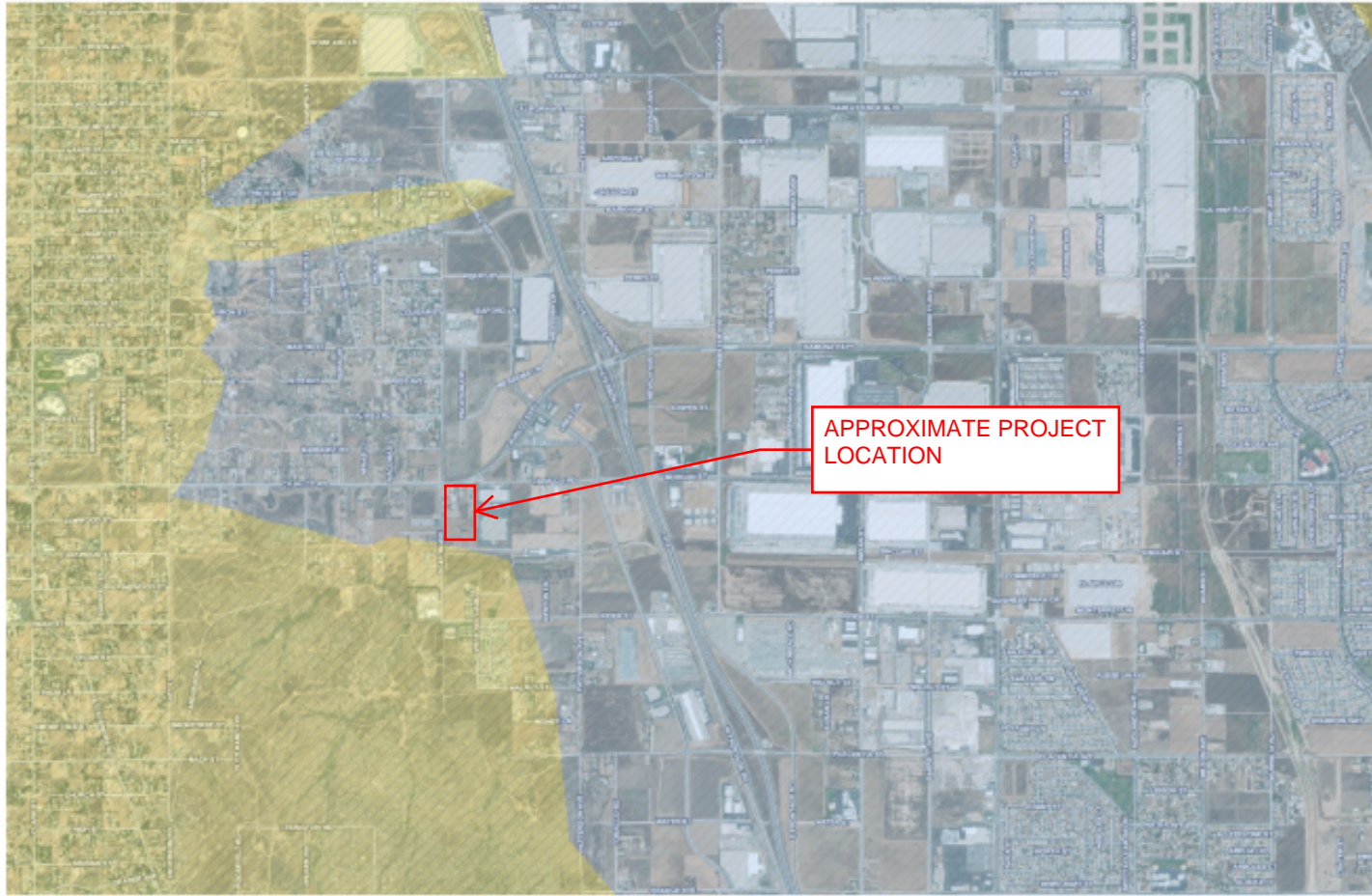

Stormwater Data

- Hydromodification Susceptibility Mapping
- 2010 - 303d/TMDL
- Hydromodification Exemption Areas

Potentially Not Exempt

Potentially Exempt

Site Address: rivco.permitrack.com

NOTE: THE PROJECT IS WITHIN THE RIVERSIDE COUNTY WAP HCOC EXEMPTION AREA APPROVED ON APRIL 20, 2017. THEREFORE, THE PROJECT SHOULD BE EXEMPT FROM THE HCOC REQUIREMENTS.

Appendix 8: Source Control

Pollutant Sources/Source Control Checklist

Note: The Source Control checklist will be prepared/refined during final engineering (construction document) stage at the time of the final WQMP.

Appendix 9: O&M

Operation and Maintenance Plan and Documentation of Finance, Maintenance and Recording Mechanisms

Note: The O&M Plan will be prepared during final engineering (construction document) stage at the time of the final WQMP.

Appendix 10: Educational Materials

BMP Fact Sheets, Maintenance Guidelines and Other End-User BMP Information

Note: The following reference materials are anticipated to be included in this Appendix during final engineering stage at the time of the final WQMP.

- **SC-10 – Non-Stormwater Discharges**
- **SC-11 – Spill Prevention, Control & Cleanup**
- **SC-30 – Outdoor Loading/Unloading**
- **SC-34 – Waste Handling and Disposal**
- **SC-41 – Building & Grounds Maintenance**
- **SC-43 – Parking/Storage Area Maintenance**
- **SC-60 – Housekeeping Practices**
- **SD-10 – Site Design and Landscape Planning**
- **SD-11 – Roof Runoff Controls**
- **SD-12 – Efficient Irrigation**
- **SD-13 – Storm Drain Signage**
- **SD-32 – Trash Storage Areas**

3.5 Bioretention Facility

Type of BMP	LID – Bioretention
Treatment Mechanisms	Infiltration, Evapotranspiration, Evaporation, Biofiltration
Maximum Drainage Area	This BMP is intended to be integrated into a project’s landscaped area in a distributed manner. Typically, contributing drainage areas to Bioretention Facilities range from less than 1 acre to a maximum of around 10 acres.
Other Names	Rain Garden, Bioretention Cell, Bioretention Basin, Biofiltration Basin, Landscaped Filter Basin, Porous Landscape Detention

Description

Bioretention Facilities are shallow, vegetated basins underlain by an engineered soil media. Healthy plant and biological activity in the root zone maintain and renew the macro-pore space in the soil and maximize plant uptake of pollutants and runoff. This keeps the Best Management Practice (BMP) from becoming clogged and allows more of the soil column to function as both a sponge (retaining water) and a highly effective and self-maintaining biofilter. In most cases, the bottom of a Bioretention Facility is unlined, which also provides an opportunity for infiltration to the extent the underlying onsite soil can accommodate. When the infiltration rate of the underlying soil is exceeded, fully biotreated flows are discharged via underdrains. Bioretention Facilities therefore will inherently achieve the maximum feasible level of infiltration and evapotranspiration and achieve the minimum feasible (but highly biotreated) discharge to the storm drain system.

Siting Considerations

These facilities work best when they are designed in a relatively level area. Unlike other BMPs, Bioretention Facilities can be used in smaller landscaped spaces on the site, such as:

- ✓ Parking islands
- ✓ Medians
- ✓ Site entrances

Landscaped areas on the site (such as may otherwise be required through minimum landscaping ordinances), can often be designed as Bioretention Facilities. This can be accomplished by:

- *Depressing* landscaped areas below adjacent impervious surfaces, rather than elevating those areas
- Grading the site to direct runoff from those impervious surfaces *into* the Bioretention Facility, rather than away from the landscaping
- Sizing and designing the depressed landscaped area as a Bioretention Facility as described in this Fact Sheet

Bioretention Facilities should however not be used downstream of areas where large amounts of sediment can clog the system. Placing a Bioretention Facility at the toe of a steep slope should also be avoided due to the potential for clogging the engineered soil media with erosion from the slope, as well as the potential for damaging the vegetation.

Design and Sizing Criteria

The recommended cross section necessary for a Bioretention Facility includes:

- Vegetated area
- 18' minimum depth of engineered soil media
- 12' minimum gravel layer depth with 6' perforated pipes (added flow control features such as orifice plates may be required to mitigate for HCOC conditions)

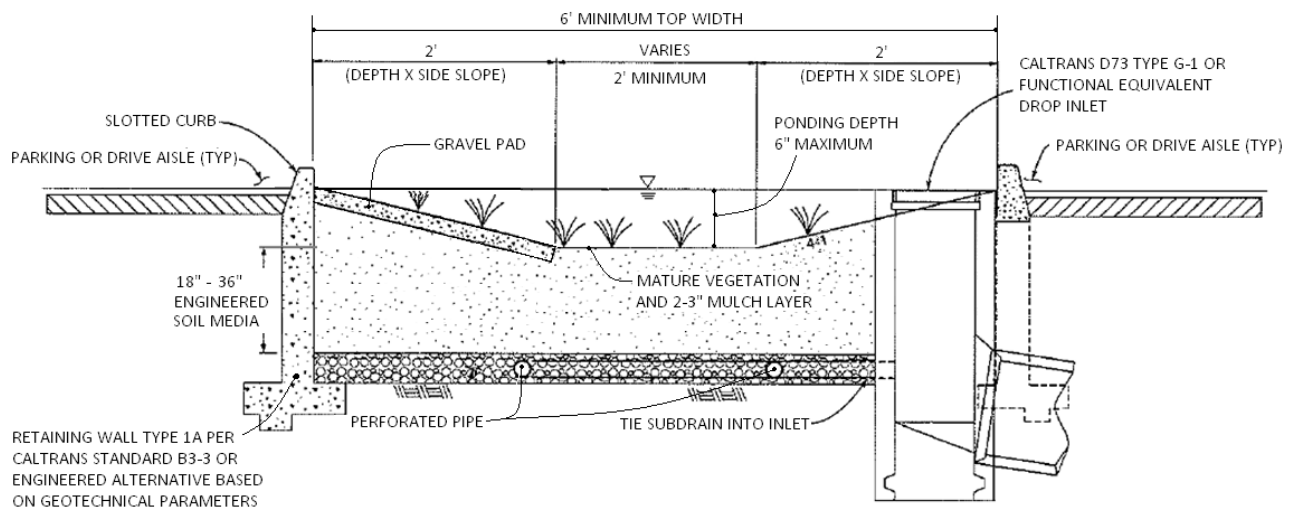

While the 18-inch minimum engineered soil media depth can be used in some cases, it is recommended to use 24 inches or a preferred 36 inches to provide an adequate root zone for the chosen plant palate. Such a design also provides for improved removal effectiveness for nutrients. The recommended ponding depth inside of a Bioretention Facility is 6 inches; measured from the flat bottom surface to the top of the water surface as shown in Figure 1.

Because this BMP is filled with an engineered soil media, pore space in the soil and gravel layer is assumed to provide storage volume. However, several considerations must be noted:

- Surcharge storage above the soil surface (6 inches) is important to assure that design flows do not bypass the BMP when runoff exceeds the soil's absorption rate.
- In cases where the Bioretention Facility contains engineered soil media deeper than 36 inches, the pore space within the engineered soil media can only be counted to the 36-inch depth.
- A maximum of 30 percent pore space can be used for the soil media whereas a maximum of 40 percent pore space can be use for the gravel layer.

Figure 1: Standard Layout for a Bioretention Facility

BIORETENTION FACILITY BMP FACT SHEET

Engineered Soil Media Requirements

The engineered soil media shall be comprised of 85 percent mineral component and 15 percent organic component, by volume, drum mixed prior to placement. The mineral component shall be a Class A sandy loam topsoil that meets the range specified in Table 1 below. The organic component shall be nitrogen stabilized compost¹, such that nitrogen does not leach from the media.

Table 1: Mineral Component Range Requirements

Percent Range	Component
70-80	Sand
15-20	Silt
5-10	Clay

The trip ticket, or certificate of compliance, shall be made available to the inspector to prove the engineered mix meets this specification.

Vegetation Requirements

Vegetative cover is important to minimize erosion and ensure that treatment occurs in the Bioretention Facility. The area should be designed for at least 70 percent mature coverage throughout the Bioretention Facility. To prevent the BMP from being used as walkways, Bioretention Facilities shall be planted with a combination of small trees, densely planted shrubs, and natural grasses. Grasses shall be native or ornamental; preferably ones that do not need to be mowed. The application of fertilizers and pesticides should be minimal. To maintain oxygen levels for the vegetation and promote biodegradation, it is important that vegetation not be completely submerged for any extended period of time. Therefore, a maximum of 6 inches of ponded water shall be used in the design to ensure that plants within the Bioretention Facility remain healthy.

A 2 to 3-inch layer of standard shredded aged hardwood mulch shall be placed as the top layer inside the Bioretention Facility. The 6-inch ponding depth shown in Figure 1 above shall be measured from the top surface of the 2 to 3-inch mulch layer.

Curb Cuts

To allow water to flow into the Bioretention Facility, 1-foot-wide (minimum) curb cuts should be placed approximately every 10 feet around the perimeter of the Bioretention Facility. Figure 2 shows a curb cut in a Bioretention Facility. Curb cut flow lines must be at or above the V_{BMP} water surface level.

¹ For more information on compost, visit the US Composting Council website at: <http://compostingcouncil.org/>

BIORETENTION FACILITY BMP FACT SHEET



Figure 2: Curb Cut located in a Bioretention Facility

To reduce erosion, a gravel pad shall be placed at each inlet point to the Bioretention Facility. The gravel should be 1- to 1.5-inch diameter in size. The gravel should overlap the curb cut opening a minimum of 6 inches. The gravel pad inside the Bioretention Facility should be flush with the finished surface at the curb cut and extend to the bottom of the slope.

In addition, place an apron of stone or concrete, a foot square or larger, inside each inlet to prevent vegetation from growing up and blocking the inlet. See Figure 3.

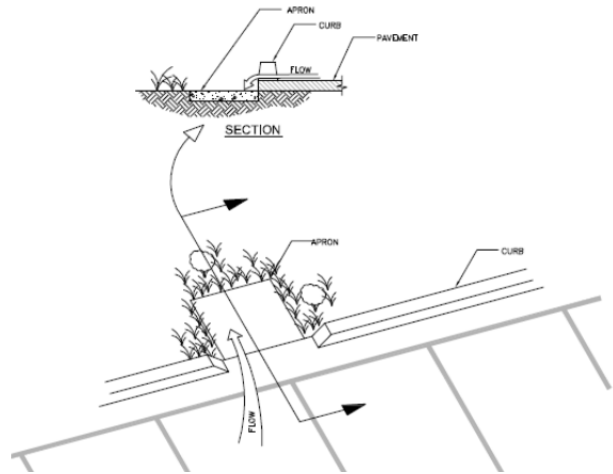

Figure 3: Apron located in a Bioretention Facility

Terracing the Landscaped Filter Basin

It is recommended that Bioretention Facilities be level. In the event the facility site slopes and lacks proper design, water would fill the lowest point of the BMP and then discharge from the basin without being treated. To ensure that the water will be held within the Bioretention Facility on sloped sites, the BMP must be terraced with nonporous check dams to provide the required storage and treatment capacity.

The terraced version of this BMP shall be used on non-flat sites with no more than a 3 percent slope. The surcharge depth cannot exceed 0.5 feet, and side slopes shall not exceed 4:1. Table 2 below shows the spacing of the check dams, and slopes shall be rounded up (i.e., 2.5 percent slope shall use 10' spacing for check dams).

Table 2: Check Dam Spacing

6" Check Dam Spacing	
Slope	Spacing
1%	25'
2%	15'
3%	10'

BIORETENTION FACILITY BMP FACT SHEET

Roof Runoff

Roof downspouts may be directed towards Bioretention Facilities. However, the downspouts must discharge onto a concrete splash block to protect the Bioretention Facility from erosion.

Retaining Walls

It is recommended that Retaining Wall Type 1A, per Caltrans Standard B3-3 or equivalent, be constructed around the entire perimeter of the Bioretention Facility. This practice will protect the sides of the Bioretention Facility from collapsing during construction and maintenance or from high service loads adjacent to the BMP. Where such service loads would not exist adjacent to the BMP, an engineered alternative may be used if signed by a licensed civil engineer.

Side Slope Requirements

Bioretention Facilities Requiring Side Slopes

The design should assure that the Bioretention Facility does not present a tripping hazard. Bioretention Facilities proposed near pedestrian areas, such as areas parallel to parking spaces or along a walkway, must have a gentle slope to the bottom of the facility. Side slopes inside of a Bioretention Facility shall be 4:1. A typical cross section for the Bioretention Facility is shown in Figure 1.

Bioretention Facilities Not Requiring Side Slopes

Where cars park perpendicular to the Bioretention Facility, side slopes are not required. A 6-inch maximum drop may be used, and the Bioretention Facility must be planted with trees and shrubs to prevent pedestrian access. In this case, a curb is not placed around the Bioretention Facility, but wheel stops shall be used to prevent vehicles from entering the Bioretention Facility, as shown in Figure 4.

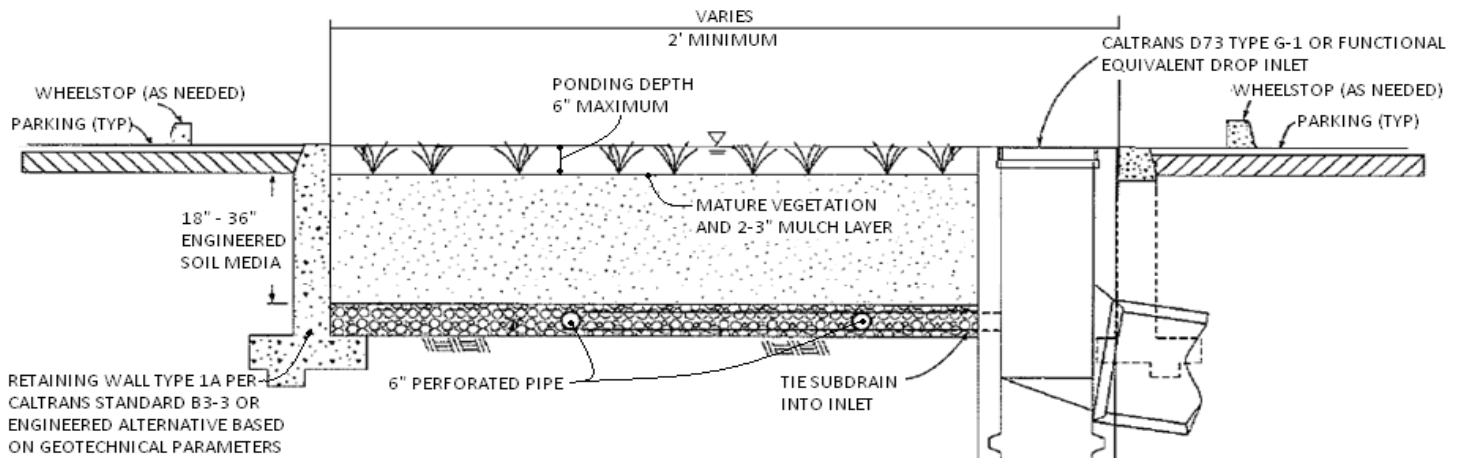

BIORETENTION FACILITY BMP FACT SHEET

Planter Boxes

Bioretention Facilities can also be placed above ground as planter boxes. Planter boxes must have a minimum width of 2 feet, a maximum surcharge depth of 6 inches, and no side slopes are necessary. Planter boxes must be constructed so as to ensure that the top surface of the engineered soil media will remain level. This option may be constructed of concrete, brick, stone or other stable materials that will not warp or bend. Chemically treated wood or galvanized steel, which has the ability to contaminate stormwater, should not be used. Planter boxes must be lined with an impermeable liner on all sides, including the bottom. Due to the impermeable liner, the inside bottom of the planter box shall be designed and constructed with a cross fall, directing treated flows within the subdrain layer toward the point where subdrain exits the planter box, and subdrains shall be oriented with drain holes oriented down. These provisions will help avoid excessive stagnant water within the gravel underdrain layer. Similar to the in-ground Bioretention Facility versions, this BMP benefits from healthy plants and biological activity in the root zone. Planter boxes should be planted with appropriately selected vegetation.



Figure 5: Planter Box

Source: LA Team Effort

Overflow

An overflow route is needed in the Bioretention Facility design to bypass stored runoff from storm events larger than V_{BMP} or in the event of facility or subdrain clogging. Overflow systems must connect to an acceptable discharge point, such as a downstream conveyance system as shown in Figure 1 and Figure 4. The inlet to the overflow structure shall be elevated inside the Bioretention Facility to be flush with the ponding surface for the design capture volume (V_{BMP}) as shown in Figure 4. This will allow the design capture volume to be fully treated by the Bioretention Facility, and for larger events to safely be conveyed to downstream systems. The overflow inlet shall **not** be located in the entrance of a Bioretention Facility, as shown in Figure 6.

BIORETENTION FACILITY BMP FACT SHEET

Underdrain Gravel and Pipes

An underdrain gravel layer and pipes shall be provided in accordance with Appendix B – Underdrains.



Figure 6: Incorrect Placement of an Overflow Inlet.

Inspection and Maintenance Schedule

The Bioretention Facility area shall be inspected for erosion, dead vegetation, soggy soils, or standing water. The use of fertilizers and pesticides on the plants inside the Bioretention Facility should be minimized.

Schedule	Activity
Ongoing	<ul style="list-style-type: none">• Keep adjacent landscape areas maintained. Remove clippings from landscape maintenance activities.• Remove trash and debris• Replace damaged grass and/or plants• Replace surface mulch layer as needed to maintain a 2-3 inch soil cover.
After storm events	<ul style="list-style-type: none">• Inspect areas for ponding
Annually	<ul style="list-style-type: none">• Inspect/clean inlets and outlets

Bioretention Facility Design Procedure

- 1) Enter the area tributary, A_T , to the Bioretention Facility.
- 2) Enter the Design Volume, V_{BMP} , determined from Section 2.1 of this Handbook.
- 3) Select the type of design used. There are two types of Bioretention Facility designs: the standard design used for most project sites that include side slopes, and the modified design used when the BMP is located perpendicular to the parking spaces or with planter boxes that do not use side slopes.
- 4) Enter the depth of the engineered soil media, d_s . The minimum depth for the engineered soil media can be 18' in limited cases, but it is recommended to use 24' or a preferred 36' to provide an adequate root zone for the chosen plant palette. Engineered soil media deeper than 36' will only get credit for the pore space in the first 36'.
- 5) Enter the top width of the Bioretention Facility.
- 6) Calculate the total effective depth, d_E , within the Bioretention Facility. The maximum allowable pore space of the soil media is 30% while the maximum allowable pore space for the gravel layer is 40%. Gravel layer deeper than 12' will only get credit for the pore space in the first 12'.

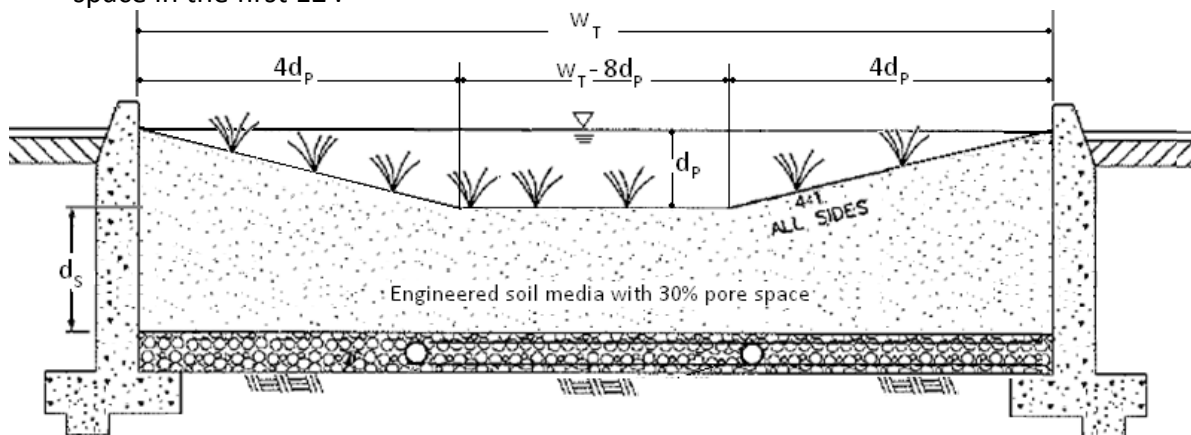

- a. For the design with side slopes the following equation shall be used to determine the total effective depth. Where, d_p is the depth of ponding within the basin.

$$d_E(\text{ft}) = \frac{0.3 \times \left[(w_T(\text{ft}) \times d_s(\text{ft})) + 4(d_p(\text{ft}))^2 \right] + 0.4 \times 1(\text{ft}) + d_p(\text{ft})[4d_p(\text{ft}) + (w_T(\text{ft}) - 8d_p(\text{ft}))]}{w_T(\text{ft})}$$

This above equation can be simplified if the maximum ponding depth of 0.5' is used. The equation below is used on the worksheet to find the minimum area required for the Bioretention Facility:

$$d_E(\text{ft}) = (0.3 \times d_s(\text{ft}) + 0.4 \times 1(\text{ft})) - \left(\frac{0.7(\text{ft}^2)}{w_T(\text{ft})} \right) + 0.5(\text{ft})$$

- b. For the design without side slopes the following equation shall be used to determine the total effective depth:

$$d_E(\text{ft}) = d_p(\text{ft}) + [(0.3) \times d_s(\text{ft}) + (0.4) \times 1(\text{ft})]$$

The equation below, using the maximum ponding depth of 0.5', is used on the worksheet to find the minimum area required for the Bioretention Facility:

$$d_E(\text{ft}) = 0.5 (\text{ft}) + [(0.3) \times d_s(\text{ft}) + (0.4) \times 1(\text{ft})]$$

- 7) Calculate the minimum surface area, A_M , required for the Bioretention Facility. This does not include the curb surrounding the Bioretention Facility or side slopes.

$$A_M(\text{ft}^2) = \frac{V_{\text{BMP}}(\text{ft}^3)}{d_E (\text{ft})}$$

- 8) Enter the proposed surface area. This area shall not be less than the minimum required surface area.
- 9) Verify that side slopes are no steeper than 4:1 in the standard design, and are not required in the modified design.
- 10) Provide the diameter, minimum 6 inches, of the perforated underdrain used in the Bioretention Facility. See Appendix B for specific information regarding perforated pipes.
- 11) Provide the slope of the site around the Bioretention Facility, if used. The maximum slope is 3 percent for a standard design.
- 12) Provide the check dam spacing, if the site around the Bioretention Facility is sloped.
- 13) Describe the vegetation used within the Bioretention Facility.

References Used to Develop this Fact Sheet

Anderson, Dale V. "Landscaped Filter Basin Soil Requirements." Riverside, May 2010.

California Department of Transportation. CalTrans Standard Plans. 15 September 2005. May 2010 <http://www.dot.ca.gov/hq/esc/oe/project_plans/HTM/stdplns-met-new99.htm>.

Camp Dresser and McKee Inc.; Larry Walker Associates. California Stormwater Best Management Practice Handbook for New Development and Redevelopment. California Stormwater Quality Association (CASQA), 2004.

Contra Costa Clean Water Program. Stormwater Quality Requirements for Development Applications. 3rd Edition. Contra Costa, 2006.

County of Los Angeles Public Works. Stormwater Best Management Practice Design and Maintenance Manual. Los Angeles, 2009.

Kim, Hunho, Eric A. Seagren and Allen P. Davis. "Engineered Bioretention for Removal of Nitrate from Stormwater Runoff." Water Environment Research 75.4 (2003): 355-366.

LA Team Effort. LA Team Effort: FREE Planter Boxes for Businesses. 2 November 2009. May 2010 <<http://lateameffort.blogspot.com/2009/11/free-planter-boxes-for-businesses-est.html>>.

Montgomery County Maryland Department of Permitting Services Water Resources Section. Biofiltration (BF). Montgomery County, 2005.

Program, Ventura Countywide Stormwater Quality Management. Technical Guidance Manual for Stormwater Quality Control Measures. Ventura, 2002.

United States Environmental Protection Agency. Storm Water Technology Fact Sheet Bioretention. Washington D.C, 1999.

Urban Drainage and Flood Control District. Urban Storm Drainage Criteria Manual Volume 3 - Best Management Practices. Vol. 3. Denver, 2008. 3 vols.

Urbonas, Ben R. Stormwater Sand Filter Sizing and Design: A Unit Operations Approach. Denver: Urban Drainage and Flood Control District, 2002.