

# MAJESTIC FREEWAY BUSINESS CENTER (BUILDING 17) PPT220009)

TRAFFIC ANALYSIS

PREPARED BY: Charlene So | cso@urbanxroads.com  
Aric Evatt | aevatt@urbanxroads.com



# TABLE OF CONTENTS

Table of Contents .....	ii
Appendices.....	iv
List of Exhibits.....	v
List of Tables .....	vi
List of Abbreviated Terms .....	vii
1 Introduction.....	1
1.1 Summary of Findings .....	1
1.2 Project Overview .....	3
1.3 Analysis Scenarios.....	3
1.4 Study Area .....	6
1.5 Deficiencies .....	8
1.6 Recommendations.....	10
1.8 Queuing Analysis .....	14
2 Methodologies .....	16
2.1 Level of Service.....	16
2.2 Intersection Capacity Analysis.....	16
2.3 Traffic Signal Warrant Analysis Methodology .....	18
2.4 Queuing Analysis .....	19
2.5 Minimum Acceptable Levels of Service (LOS).....	20
2.6 Deficiency Criteria .....	21
2.7 Project Fair Share Calculation Methodology .....	21
3 Area Conditions .....	22
3.1 Existing Circulation Network .....	22
3.2 County of Riverside General Plan Circulation Element.....	22
3.3 City of Perris General Plan Circulation Element.....	26
3.4 Bicycle & Pedestrian Facilities.....	26
3.5 Transit Service.....	26
3.6 Truck Routes.....	26
3.7 Existing (2022) Traffic Counts .....	34
3.8 Intersection Operations Analysis .....	36
3.9 Traffic Signal Warrants Analysis .....	36
3.10 Queuing Analysis .....	36
4 Projected Future Traffic.....	38
4.1 Project Trip Generation .....	38
4.2 Project Trip Distribution .....	40

4.3	Modal Split.....	40
4.4	Project Trip Assignment.....	43
4.5	Background Traffic.....	43
4.6	Cumulative Development Traffic.....	45
4.7	Near-Term Traffic Conditions.....	45
5	EAP (2025) Traffic Conditions.....	50
5.1	Roadway Improvements .....	50
5.2	EAP (2025) Traffic Volume Forecasts.....	50
5.3	Intersection Operations Analysis.....	50
5.4	Traffic Signal Warrants Analysis.....	52
5.5	Queuing Analysis .....	52
5.6	Project Deficiencies and Recommended Improvements.....	53
6	EAPC (2025) Traffic Conditions .....	54
6.1	Roadway Improvements .....	54
6.2	EAPC (2025) Traffic Volume Forecasts.....	54
6.3	Intersection Operations Analysis.....	54
6.4	Traffic Signal Warrants Analysis.....	56
6.5	Queuing Analysis .....	56
6.6	Near-Term Deficiencies and Recommended Improvements.....	57
7	Local and Regional Funding Mechanisms.....	60
7.1	Riverside County Transportation Uniform Mitigation Fee (TUMF).....	60
7.2	Riverside County Development Impact Fee (DIF) Program.....	60
7.3	Measure A.....	60
7.4	Fair Share Contribution.....	61
8	References.....	62

## **APPENDICES**

Appendix 1.1: Approved Traffic Study Scoping Agreement

Appendix 1.2: Site Adjacent Queues

Appendix 3.1: Traffic Counts

Appendix 3.2: Existing (2022) Conditions Intersection Operations Analysis Worksheets

Appendix 3.3: Existing (2022) Conditions Traffic Signal Warrant Analysis Worksheets

Appendix 3.4: Existing (2022) Conditions Freeway Off-Ramp Queuing Analysis Worksheets

Appendix 5.1: EAP (2025) Conditions Intersection Operations Analysis Worksheets

Appendix 5.2: EAP (2025) Conditions Traffic Signal Warrant Analysis Worksheets

Appendix 5.3: EAP (2025) Conditions Freeway Off-Ramp Queuing Analysis Worksheets

Appendix 6.1: EAPC (2025) Conditions Intersection Operations Analysis Worksheets

Appendix 6.2: EAPC (2025) Conditions Traffic Signal Warrant Analysis Worksheets

Appendix 6.3: EAPC (2025) Conditions Freeway Off-Ramp Queuing Analysis Worksheets

Appendix 6.4: EAPC (2025) Conditions Intersection Operations Analysis Worksheets With Improvements

Appendix 6.5: EAPC (2025) Conditions Freeway Off-Ramp Queuing Analysis Worksheets With Improvements



## LIST OF EXHIBITS

Exhibit 1-1: Location Map.....	2
Exhibit 1-2: Preliminary Site Plan .....	5
Exhibit 1-3: Study Area.....	7
Exhibit 1-4: Site Access Recommendations .....	11
Exhibit 3-1: Existing Number of Through Lanes and Intersection Controls.....	23
Exhibit 3-2: County of Riverside General Plan Circulation Element .....	24
Exhibit 3-3: County of Riverside General Plan Roadway Cross-Sections .....	25
Exhibit 3-4: City of Perris General Plan Circulation Element .....	27
Exhibit 3-5: City of Perris General Plan Roadway Cross-Sections.....	28
Exhibit 3-6: County of Riverside General Plan Bike Network .....	29
Exhibit 3-7: City of Perris Bike Plan .....	30
Exhibit 3-8: Existing Pedestrian Facilities .....	31
Exhibit 3-9: Existing Transit Routes.....	32
Exhibit 3-10: City of Perris Truck Routes .....	33
Exhibit 3-11: Existing (2022) Traffic Volumes.....	35
Exhibit 4-1: Project (Truck) Trip Distribution.....	41
Exhibit 4-2: Project (Passenger Car) Trip Distribution .....	42
Exhibit 4-3: Project Only Traffic volumes .....	44
Exhibit 4-4: Cumulative Development Location Map .....	46
Exhibit 4-5: Cumulative Only Traffic Volumes .....	47
Exhibit 5-1: EAP (2025) Traffic Volumes.....	51
Exhibit 6-1: EAPC (2025) Traffic Volumes .....	55

## LIST OF TABLES

Table 1-1: Intersection Analysis Locations .....	6
Table 1-2: Summary of LOS.....	8
Table 1-3: Summary of Improvements by Analysis Scenario .....	13
Table 1-4: Peak Hour Queuing Analysis for Site Adjacent Intersections.....	14
Table 2-1: Signalized Intersection LOS Thresholds.....	17
Table 2-2: Unsignalized Intersection LOS Thresholds .....	18
Table 2-3: Traffic Signal Warrant Analysis Locations.....	19
Table 3-1: Intersection Analysis for Existing (2022) Conditions .....	36
Table 3-2: Peak Hour Queuing Summary for Existing (2022) Conditions .....	37
Table 4-1: Trip Generation Rates.....	39
Table 4-2: Project Trip Generation Summary.....	40
Table 4-7: Cumulative Development land use Summary .....	48
Table 5-1: Intersection Analysis for EAP (2025) Conditions .....	52
Table 5-2: Peak Hour Queuing Summary for EAP (2025) Conditions.....	53
Table 6-1: Intersection Analysis for EAPC (2025) Conditions.....	56
Table 6-2: Peak Hour Queuing Summary for EAPC (2025) Conditions .....	57
Table 6-3: Intersection Analysis for EAPC (2025) Conditions With Improvements.....	58
Table 6-4: Peak Hour Queuing Summary for EAPC (2025) Conditions With improvements.....	58
Table 7-1: Project Fair Share Calculations.....	61

## LIST OF ABBREVIATED TERMS

(1)	Reference
ADT	Average Daily Traffic
CAMUTCD	California Manual on Uniform Traffic Control Devices
Caltrans	California Department of Transportation
CEQA	California Environmental Quality Act
CMP	Congestion Management Program
DIF	Development Impact Fee
EAP	Existing Plus Ambient Growth Plus Project
EAPC	Existing Plus Ambient Growth Plus Project Plus Cumulative
HCM	Highway Capacity Manual
ITE	Institute of Transportation Engineers
LOS	Level of Service
OPR	Office of Planning and Research
PHF	Peak Hour Factor
Project	Majestic Freeway Business Center (Building 17)
RCTC	Riverside County Transportation Commission
RTA	Riverside Transit Authority
SCAG	Southern California Association of Governments
sf	Square Feet
SHS	State Highway System
TA	Traffic Analysis
TUMF	Transportation Uniform Mitigation Fee
WRCOG	Western Riverside Council of Governments
v/c	Volume to Capacity
VMT	Vehicle Miles Traveled
vphgpl	Vehicles per Hour Green per Lane

This page intentionally left blank

# 1 INTRODUCTION

This report presents the results of the Traffic Analysis (TA) for Majestic Freeway Business Center (Building 17) development (“Project”), which is located on the northeast corner of Harvill Avenue and America’s Tire Drive in the County of Riverside, as shown on Exhibit 1-1. The purpose of this TA is to evaluate the potential circulation system deficiencies that may result from the development of the proposed Project, and where necessary recommend improvements to achieve acceptable operations consistent with the County’s General Plan level of service goals and policies. This TA has been prepared in accordance with the County of Riverside’s Transportation Analysis Guidelines for Level of Service and Vehicle Miles Traveled (December 2020) and through consultation with County of Riverside staff during the scoping process. (1) The Project traffic study scoping agreement is provided in Appendix 1.1 of this TA, which has been reviewed and approved by the County of Riverside.

## 1.1 SUMMARY OF FINDINGS

The Project is to construct the following improvements as design features in conjunction with development of the site:

- Harvill Avenue is currently built to its ultimate cross-section as a Major Highway (118-foot right-of-way) along the Project’s frontage between Perry Street and Martin Street consistent with the County’s standards. However, the Project should modify the existing curb-and-gutter improvements to accommodate the proposed access at Driveway 4 on Harvill Avenue.
- America’s Tire Drive is a private roadway, and no further widening is proposed; however, the northern curb should be modified to accommodate the proposed site access points. In addition, the Project should implement its other frontage improvements which include curb-and-gutter modifications, sidewalk, and landscaping improvements.
- Project to install stop controls for all egress traffic from each Project driveway. All driveways will allow full turning movements.

Additional details and intersection lane geometrics are provided in Section 1.6 Recommendations of this report. The proposed Project is not anticipated to require the construction of any off-site improvements but would need to contribute to improvement needs identified at off-site intersections for future near-term cumulative traffic conditions. As such, the Project Applicant’s responsibility for the Project’s contributions towards deficient off-site intersections is fulfilled through payment into pre-existing fee programs (if applicable) and/or fair share contributions that would be assigned to the future construction of the identified recommended improvements. The Project Applicant would be required to pay requisite fees consistent with the County’s requirements (see Section 7 Local and Regional Funding Mechanisms).

**EXHIBIT 1-1: LOCATION MAP**



## 1.2 PROJECT OVERVIEW

A preliminary site plan for the proposed Project is shown on Exhibit 1-2. The proposed Project building is 256,148 square feet of building space, however, in an effort to conduct a conservative analysis a 266,955 square foot warehouse building has been evaluated in order to account for any future minor revisions in building size. As indicated on Exhibit 1-2, vehicular access will be provided to Harvill Avenue and America's Tire Drive. All driveways are proposed to accommodate full access. Driveway 1 on Harvill Avenue and Driveway 2 on America's Tire Drive are proposed to serve passenger cars only while the remaining two driveways on America's Tire Drive would serve only trucks. Regional access to the Project site is available from the I-215 Freeway via Harley Knox Boulevard and Ramona Expressway interchanges. In order to develop the traffic characteristics of the proposed project, trip-generation statistics published in the Institute of Transportation Engineers (ITE) Trip Generation Manual for the proposed high-cube transload and short-term storage warehouse land use. (2) The Project is anticipated to generate a net total of 378 two-way trips per day with 23 AM peak hour trips and 26 PM peak hour trips (actual vehicles). The assumptions and methods used to estimate the Project's trip generation characteristics are discussed in greater detail in Section 4.1 Project Trip Generation of this report.

## 1.3 ANALYSIS SCENARIOS

For the purposes of this traffic study, potential deficiencies to traffic and circulation have been assessed for each of the following conditions:

- Existing (2022) Conditions
- Existing plus Ambient Growth plus Project (EAP) (2025) Conditions
- Existing plus Ambient Growth plus Project plus Cumulative (EAPC) (2025) Conditions

### 1.3.1 EXISTING (2022) CONDITIONS

Information for Existing (2022) conditions is disclosed to represent the baseline traffic conditions as they existed at the time this report was prepared. For a detailed discussion on the existing traffic counts, see Section 3.7 Existing Traffic Counts.

### 1.3.2 EAP (2025) CONDITIONS

The EAP (2025) conditions analysis determines the potential circulation system deficiencies based on a comparison of the EAP traffic conditions to Existing conditions. The roadway network is similar to Existing conditions except for new connections to be constructed by the Project. To account for background traffic growth, an ambient growth factor from Existing (2022) conditions of 6.12% (2 percent per year, compounded over 3 years) is included for EAP (2025) traffic conditions. The assumed ambient growth factor is based on the requirements per the County of Riverside traffic study guidelines. Consistent with County traffic study guidelines, the EAP analysis is intended to identify "Opening Year" deficiencies associated with the development of the proposed Project based on the expected background growth within the study area.





EXHIBIT 1-2: PRELIMINARY SITE PLAN

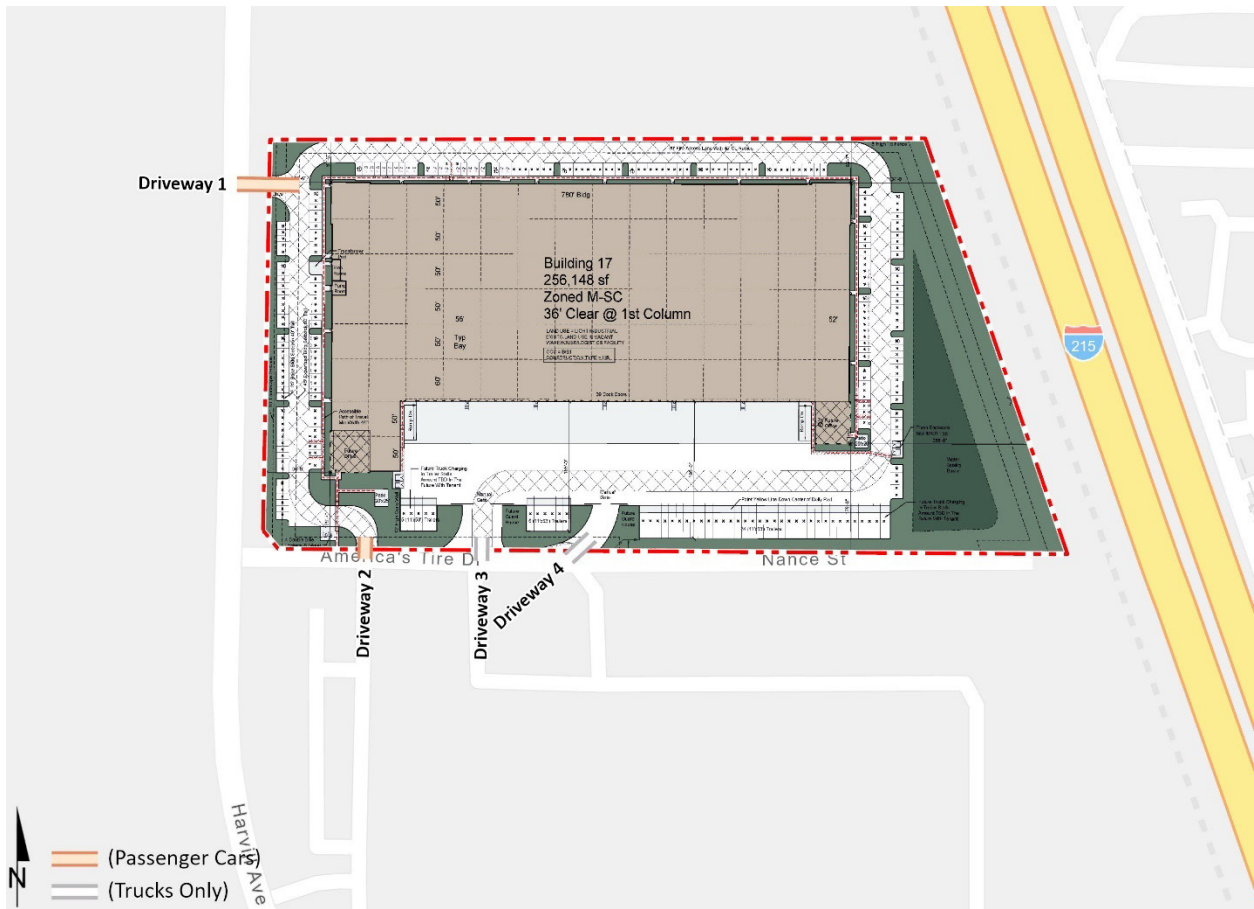

### 1.3.3 EAPC (2025) CONDITIONS

The EAPC (2025) traffic conditions analysis determines the potential near-term cumulative circulation system deficiencies. The roadway network is similar to Existing conditions except for new connections to be constructed by the Project. To account for background traffic growth, an ambient growth factor from Existing (2022) conditions of 6.12% (2 percent per year, compounded over 3 years) is included for EAPC (2025) traffic. Conservatively, this TA estimates the area ambient traffic growth and then adds traffic generated by other known or probable related projects. These related projects are at least in part already accounted for in the assumed ambient growth rates; and some of these related projects may not be implemented and operational within the 2025 Opening Year time frame assumed for the Project. The resulting traffic growth utilized in the TA (ambient growth factor plus traffic generated by related projects) would therefore tend to overstate rather than understate background cumulative traffic deficiencies under 2025 conditions.

## 1.4 STUDY AREA

To ensure that this TA satisfies the County of Riverside’s traffic study requirements, Urban Crossroads, Inc. prepared a Project traffic study scoping package for review by County of Riverside staff prior to the preparation of this report. This agreement provides an outline of the Project study area, trip generation, trip distribution, and analysis methodology. The agreement approved by the County is included in Appendix 1.1 of this TA.

The 5 study area intersections shown on Exhibit 1-3 and listed in Table 1-1 were selected for evaluation in this TA based on consultation with County of Riverside staff. At a minimum, the study area includes intersections where the Project is anticipated to contribute 50 or more peak hour trips per the County’s Guidelines. (1) The “50 peak hour trip” criterion represents a minimum number of trips at which a typical intersection would have the potential to be affected by a given development proposal. The 50 peak hour trip criterion is a traffic engineering rule of thumb that is accepted and used throughout the County for the purposes of estimating a potential area of influence (i.e., study area).

**TABLE 1-1: INTERSECTION ANALYSIS LOCATIONS**

#	Intersection	Jurisdiction	CMP?
1	Harvill Av. & Driveway 1	County of Riverside	No
2	Harvill Av. & America's Tire Dr.	County of Riverside	No
3	Harvill Av. & Cajalco Exwy.	County of Riverside	No
4	I-215 SB Ramps & Ramona Exwy.	County, Perris, Caltrans	No
5	I-215 NB Ramps & Ramona Exwy.	Perris, Caltrans	No

EXHIBIT 1-3: STUDY AREA

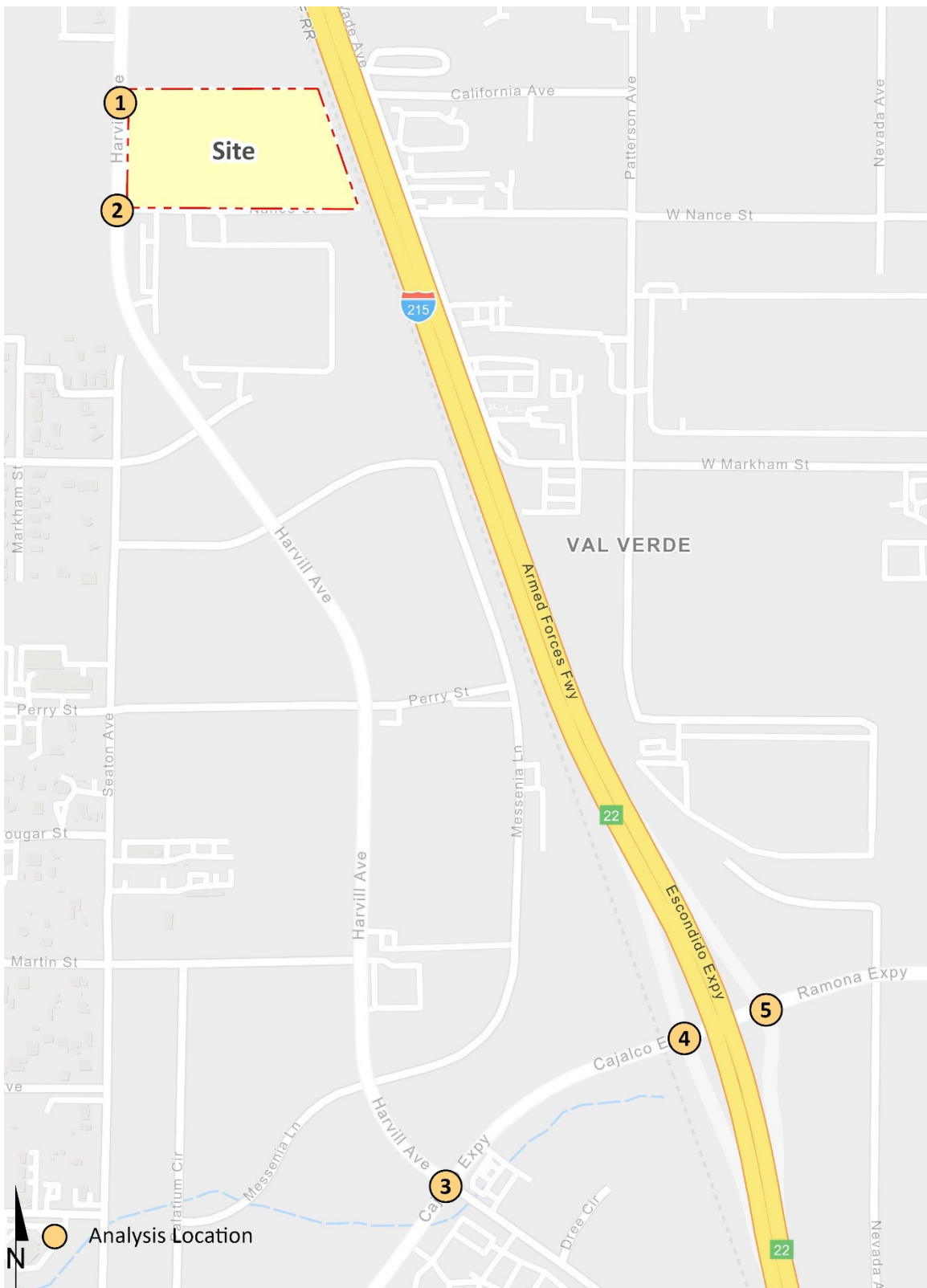

The intent of a Congestion Management Program (CMP) is to more directly link land use, transportation, and air quality, thereby prompting reasonable growth management programs that will effectively utilize new transportation funds, alleviate traffic congestion and related deficiencies, and improve air quality. The County of Riverside CMP became effective with the passage of Proposition 111 in 1990 and most recently updated in 2019 as part of the Riverside County Long Range Transportation Study. The Riverside County Transportation Commission (RCTC) adopted the 2019 CMP for the County of Riverside in December 2019. (3) There are no study area intersections identified as a Riverside County CMP intersection.

## 1.5 DEFICIENCIES

This section provides a summary of deficiencies by analysis scenario. Section 2 Methodologies provides information on the methodologies used in the analysis and Section 5 EAP (2025) Traffic Conditions and Section 6 EAPC (2025) Traffic Conditions include the detailed analysis. A summary of LOS results for all analysis scenarios is presented on Table 1-2.

**TABLE 1-2: SUMMARY OF LOS**

# Intersection	Existing		EAP		EAPC	
	AM	PM	AM	PM	AM	PM
1 Harvill Av. & Driveway 1	N/A	N/A	●	●	●	●
2 Harvill Av. & America's Tire Dr.	●	●	●	●	●	●
3 Harvill Av. & Cajalco Exwy.	●	●	●	●	●	●
4 I-215 SB Ramps & Ramona Exwy.	●	●	●	●	●	●
5 I-215 NB Ramps & Ramona Exwy.	●	●	●	●	●	●

● = A - D   ● = E   ● = F

### 1.5.1 EXISTING (2022) CONDITIONS

#### Intersections

The study area intersections are currently operating at an acceptable LOS during the peak hours.

#### Queues

There are no movements that are currently experiencing queuing issues during the weekday AM or weekday PM peak 95<sup>th</sup> percentile traffic flows.

### 1.5.2 EAP (2025) CONDITIONS

#### Intersections

The study area intersections are anticipated to continue to operate at an acceptable LOS with the addition of Project traffic under EAP (2025) traffic conditions.

## Queues

Consistent with Existing traffic conditions, there are no movements that are anticipated to experience queuing issues during the weekday AM or weekday PM peak 95<sup>th</sup> percentile traffic flows with the addition of Project traffic for EAP (2025) traffic conditions.

### 1.5.3 EAPC (2025) CONDITIONS

#### Intersections

The following study area intersections are anticipated to operate at an unacceptable LOS under EAPC (2025) traffic conditions:

- Harvill Av. & Cajalco Exwy. (#3) – LOS F AM and PM peak hours
- I-215 SB Ramps & Ramona Exwy. (#4) – LOS F AM and PM peak hours
- I-215 NB Ramps & Ramona Exwy. (#5) – LOS F AM and PM peak hours

#### Queues

The following turning movements are anticipated to experience queuing issues during the weekday AM or weekday PM peak 95<sup>th</sup> percentile traffic flows for EAPC (2025) traffic conditions:

- I-215 SB Ramps & Ramona Exwy. (#4): Southbound Left (AM and PM peak hours, Southbound Left-Through (AM and PM peak hours), and Southbound Right (AM peak hour only)
- I-215 NB Ramps & Ramona Exwy. (#5): Northbound Right (AM peak hour only)

## 1.6 RECOMMENDATIONS

### 1.6.1 SITE ADJACENT AND SITE ACCESS RECOMMENDATIONS

The following recommendations are based on the minimum improvements needed to accommodate site access and maintain acceptable peak hour operations for the proposed Project. The site adjacent recommendations are shown on Exhibit 1-4.

Recommendation 1 – Harvill Avenue & Driveway 1 (#1) – The following improvements are necessary to accommodate site access:

- Project to install a stop control on the westbound approach (egress Project traffic) to implement a cross-street stop-controlled intersection. Driveway will allow full access and will serve passenger cars only.
- Project should construct and accommodate a minimum 100-foot southbound left turn lane at Driveway 1 within the painted median. Driveway 1 should align with the proposed driveway for Building 18 on the west side of Harvill Avenue.

Harvill Avenue & America's Tire Drive (#2) – Project to maintain the existing traffic control and lane geometrics.

- Project to install a stop control on the southbound approach (egress Project traffic) to implement a cross-street stop-controlled intersection. Driveway will allow full access and will serve both passenger cars and trucks.

Recommendation 2 – Driveway 2 & America's Tire Drive – The following improvement is necessary to accommodate site access:

- Project to install a stop control on the southbound approach (egress Project traffic) to implement a cross-street stop-controlled intersection. Driveway will allow full access and will serve passenger cars only.

Recommendation 3 – Driveway 3 & America's Tire Drive – The following improvement is necessary to accommodate site access:

- Project to install a stop control on the southbound approach (egress Project traffic) to implement a cross-street stop-controlled intersection. Driveway will allow full access and will serve trucks only.

Recommendation 4 – Driveway 4 & America's Tire Drive – The following improvement is necessary to accommodate site access:

- Project to install a stop control on the southbound approach (egress Project traffic) to implement a cross-street stop-controlled intersection. Driveway will allow full access and will serve trucks only.

EXHIBIT 1-4: SITE ACCESS RECOMMENDATIONS

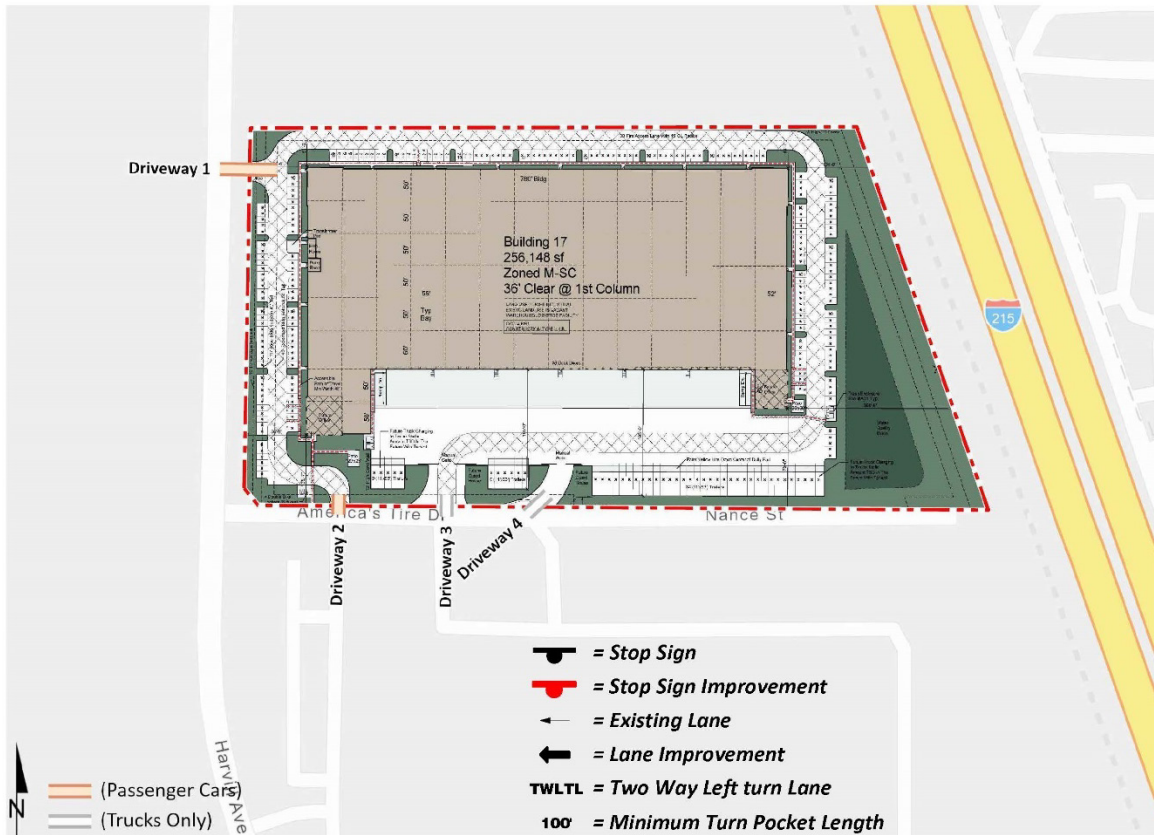

1	Harvill Av. & Dwy. 1	2	Harvill Av. & America's Tire Dr.	Dwy. 2 & America's Tire Dr.	Dwy. 3 & America's Tire Dr.	Dwy. 4 & America's Tire Dr.



Recommendation 5 – Harvill Avenue is a north-south oriented roadway located on the Project's western boundary. Harvill Avenue is currently constructed to its ultimate cross-section as a Major Arterial (118-foot right-of-way) consistent with the County's standards; however, the Project should construct the driveways necessary to accommodate site access, including a 100-foot southbound left turn lane at Driveway 1.

Recommendation 6 – America's Tire Drive is an east-west oriented roadway located along the Project's southern boundary. America's Tire Drive is a private roadway, and no further widening is proposed; however, the northern curb should be modified to accommodate the proposed site access points. In addition, the Project should implement its other frontage improvements which include curb-and-gutter modifications, sidewalk, and landscaping improvements.

On-site traffic signing and striping should be implemented agreeable with the provisions of the California Manual on Uniform Traffic Control Devices (CA MUTCD) and in conjunction with detailed construction plans for the Project site.

Sight distance at each project access point should be reviewed with respect to standard Caltrans and County of Riverside sight distance standards at the time of preparation of final grading, landscape, and street improvement plans.

### **1.6.2 OFF-SITE RECOMMENDATIONS**

The recommended improvements needed to address the deficiencies identified under Existing (2022), EAP (2025), and EAPC (2025) traffic conditions are shown in Table 1-3. Improvements that appear under EAP (2025) that are not also identified for Existing (2022) traffic conditions would be the Project's responsibility to implement/construct in order to maintain acceptable LOS. For those remaining improvements listed in Table 1-3 and not constructed as part of the Project, the Project Applicant's responsibility for the Project's contributions towards deficient intersections is fulfilled through payment of fair share or payment of fees (if applicable) that would be assigned to construction of the identified recommended improvements. The Project Applicant would be required to pay fair share fees and participate in pre-existing fee programs consistent with the County's requirements (see Section 7 Local and Regional Funding Mechanisms).



**TABLE 1-3: SUMMARY OF IMPROVEMENTS BY ANALYSIS SCENARIO**

#	Intersection Location	Jurisdiction	EAP	Analysis Scenario EAPC	Improvements in DIF, TUMF, etc. <sup>1</sup>	Project Responsibility <sup>2</sup>	Project Fair Share <sup>3</sup>
3	Harvill Av. & Cajalco Exwy.	County	- None	- Add 3rd EB through lane	No	Fair Share	0.5%
				- Add 3rd WB through lane	No	Fair Share	
4	I-215 SB Ramps & Ramona Exwy.	Caltrans, Perris, County	- None	- Add 2nd WB left turn lane	Yes (TUMF)	Fees	0.3%
				- Add 3rd EB through lane	Yes (TUMF)	Fees	
				- Add 3rd WB through lane	Yes (TUMF)	Fees	
				- Add 2nd SB left turn lane	No	Fair Share	
				- Add EB right turn lane	No	Fair Share	
5	I-215 NB Ramps & Ramona Exwy.	Caltrans, Perris, County	- None	- Add 2nd EB left turn lane	Yes (TUMF)	Fees	0.2%
				- Add 3rd EB through lane	Yes (TUMF)	Fees	
				- Add 3rd WB through lane	Yes (TUMF)	Fees	
				- Add WB free-right turn lane	No	Fair Share	

<sup>1</sup> Improvements included in TUMF Nexus or County DIF programs have been identified as such.

<sup>2</sup> Program improvements constructed by Project may be eligible for fee credit. In lieu fee payment is at discretion of County.

Represents the fair share percentage for the Project during the most impacted peak hour. Identifies the Project's responsibility to construct an off-site improvement, contribute fair share, or fee payment towards the improvements shown. If identified as a Project construct obligation/in a fee program, then no fair share percentage has been identified.

<sup>3</sup> Total project fair share is applicable to the improvements which are not already included in the County DIF/TUMF for those intersections wholly or partially within the County.

## 1.8 QUEUING ANALYSIS

The traffic modeling and signal timing optimization software package SimTraffic has been utilized to assess the queues. SimTraffic is designed to model networks of signalized and unsignalized intersections, with the primary purpose of checking and fine-tuning signal operations. SimTraffic uses the input parameters from Synchro to generate random simulations. These random simulations generated by SimTraffic have been utilized to determine the 95<sup>th</sup> percentile queue lengths observed for each applicable turn lane. A SimTraffic simulation has been recorded up to 5 times, during the weekday AM and weekday PM peak hours, and has been seeded for 15-minute periods with 60-minute recording intervals. The results of the queuing analysis are shown in Table 1-4 and the worksheets for the weekday AM and PM peak hours are provided in Appendix 1.2 of this report for EAPC (2025) traffic conditions. No site adjacent queues are anticipated with the proposed improvements.

**TABLE 1-4: PEAK HOUR QUEUING ANALYSIS FOR SITE ADJACENT INTERSECTIONS**

Intersection	Movement	Available Stacking Distance (Feet) <sup>3</sup>	95th Percentile Queue (Feet)		Acceptable? <sup>1</sup>	
			AM Peak	PM Peak	AM	PM
Harvill Av. & Driveway 1	SBL	100	20	11	Yes	Yes
	WBL/R	50	12	23	Yes	Yes
Harvill Av. & America's Tire	SBL	130	24	7	Yes	Yes
	WBL	475	11	32	Yes	Yes
	WBR	475	22	31	Yes	Yes

<sup>1</sup> Stacking Distance is acceptable if the required stacking distance is less than or equal to the stacking distance provided. An additional 15 feet of stacking which is assumed to be provided in the transition for turn pockets is reflected in the stacking distance shown on this table, where applicable.

This page intentionally left blank

## 2 METHODOLOGIES

This section of the report presents the methodologies used to perform the traffic analyses summarized in this report. The methodologies described are consistent with County of Riverside's Traffic Study Guidelines.

### 2.1 LEVEL OF SERVICE

Traffic operations of roadway facilities are described using the term "Level of Service" (LOS). LOS is a qualitative description of traffic flow based on several factors, such as speed, travel time, delay, and freedom to maneuver. Six levels are typically defined ranging from LOS A, representing completely free-flow conditions, to LOS F, representing breakdown in flow resulting in stop-and-go conditions. LOS E represents operations at or near capacity, an unstable level where vehicles are operating with the minimum spacing for maintaining uniform flow.

### 2.2 INTERSECTION CAPACITY ANALYSIS

The definitions of LOS for interrupted traffic flow (flow restrained by the existence of traffic signals and other traffic control devices) differ slightly depending on the type of traffic control. The LOS is typically dependent on the quality of traffic flow at the intersections along a roadway. The 6<sup>th</sup> Edition Highway Capacity Manual (HCM) methodology expresses the LOS at an intersection in terms of delay time for the various intersection approaches. (4) The HCM uses different procedures depending on the type of intersection control.

#### 2.2.1 SIGNALIZED INTERSECTIONS

The County of Riverside, City of Perris, and California Department of Transportation (Caltrans) require signalized intersection operations analysis based on the methodology described in the HCM. (4) Intersection LOS operations are based on an intersection's average control delay. Control delay includes initial deceleration delay, queue move-up time, stopped delay, and final acceleration delay. For signalized intersections LOS is related to the average control delay per vehicle and is correlated to a LOS designation as described on Table 2-1.

The traffic modeling and signal timing optimization software package Synchro (Version 11) has been utilized to analyze signalized intersections. Synchro is a macroscopic traffic software program that is based on the signalized intersection capacity analysis as specified in the HCM. Macroscopic level models represent traffic in terms of aggregate measures for each movement at the study intersections. Equations are used to determine measures of effectiveness such as delay and queue length. The level of service and capacity analysis performed by Synchro takes into consideration optimization and coordination of signalized intersections within a network.

**TABLE 2-1: SIGNALIZED INTERSECTION LOS THRESHOLDS**

Description	Average Control Delay (Seconds), V/C ≤ 1.0	Level of Service, V/C ≤ 1.0 <sup>1</sup>
Operations with very low delay occurring with favorable progression and/or short cycle length.	0 to 10.00	A
Operations with low delay occurring with good progression and/or short cycle lengths.	10.01 to 20.00	B
Operations with average delays resulting from fair progression and/or longer cycle lengths. Individual cycle failures begin to appear.	20.01 to 35.00	C
Operations with longer delays due to a combination of unfavorable progression, long cycle lengths, or high V/C ratios. Many vehicles stop and individual cycle failures are noticeable.	35.01 to 55.00	D
Operations with high delay values indicating poor progression, long cycle lengths, and high V/C ratios. Individual cycle failures are frequent occurrences. This is considered to be the limit of acceptable delay.	55.01 to 80.00	E
Operation with delays unacceptable to most drivers occurring due to over saturation, poor progression, or very long cycle lengths.	80.01 and up	F

Source: HCM, 6th Edition

<sup>1</sup> If V/C is greater than 1.0 then LOS is F per HCM.

A saturation flow rate of 1900 has been utilized for all study area intersections. The peak hour traffic volumes have been adjusted using a peak hour factor (PHF) to reflect peak 15-minute volumes. Customary practice for LOS analysis is to use a peak 15-minute rate of flow. However, flow rates are typically expressed in vehicles per hour. The PHF is the relationship between the peak 15-minute flow rate and the full hourly volume (e.g.,  $PHF = \frac{\text{Hourly Volume}}{4 \times \text{Peak 15-minute Flow Rate}}$ ). The use of a 15-minute PHF produces a more detailed analysis as compared to analyzing vehicles per hour. Existing PHFs have been used for all analysis scenarios. Per the HCM, PHF values over 0.95 often are indicative of high traffic volumes with capacity constraints on peak hour flows while lower PHF values are indicative of greater variability of flow during the peak hour. (4)

### 2.2.2 UNSIGNALIZED INTERSECTIONS

The County of Riverside requires the operations of unsignalized intersections be evaluated using the methodology described in the HCM. (4) The LOS rating is based on the weighted average control delay expressed in seconds per vehicle (see Table 2-2). At two-way or side-street stop-controlled intersections, LOS is calculated for each controlled movement and for the left turn movement from the major street, as well as for the intersection as a whole. For approaches composed of a single lane, the delay is computed as the average of all movements in that lane. Delay for the intersection is reported for the worst individual movement at a two-way stop-controlled intersection. For all-way stop controlled intersections, LOS is computed for the intersection as a whole (average delay).

**TABLE 2-2: UNSIGNALIZED INTERSECTION LOS THRESHOLDS**

Description	Average Control Delay (Seconds), $V/C \leq 1.0$	Level of Service, $V/C \leq 1.0^1$
Little or no delays.	0 to 10.00	A
Short traffic delays.	10.01 to 15.00	B
Average traffic delays.	15.01 to 25.00	C
Long traffic delays.	25.01 to 35.00	D
Very long traffic delays.	35.01 to 50.00	E
Extreme traffic delays with intersection capacity exceeded.	> 50.00	F

Source: HCM, 6th Edition

<sup>1</sup> If V/C is greater than 1.0 then LOS is F per HCM.

### 2.3 TRAFFIC SIGNAL WARRANT ANALYSIS METHODOLOGY

The term “signal warrants” refers to the list of established criteria used by Caltrans and other public agencies to quantitatively justify or determine the potential need for installation of a traffic signal at an otherwise unsignalized intersection. This TA uses the signal warrant criteria presented in the latest edition of the Caltrans California Manual on Uniform Traffic Control Devices (CA MUTCD). (5)

The signal warrant criteria for Existing study area intersections are based upon several factors, including volume of vehicular and pedestrian traffic, frequency of accidents, and location of school areas. The CA MUTCD indicates that the installation of a traffic signal should be considered if one or more of the signal warrants are met. (5) Specifically, this TA utilizes the Peak Hour Volume-based Warrant 3 as the appropriate representative traffic signal warrant analysis for existing traffic conditions and for all future analysis scenarios for existing unsignalized intersections. Warrant 3 is appropriate to use for this TA because it provides specialized warrant criteria for intersections with rural characteristics. For the purposes of this study, the speed limit was the basis for determining whether Urban or Rural warrants were used for a given intersection. Rural warrants have been used as posted speed limits on the major roadways with unsignalized intersections are over 40 miles per hour while urban warrants have been used where speeds are 40 miles per hour or below.

Future intersections that do not currently exist have been assessed regarding the potential need for new traffic signals based on future average daily traffic (ADT) volumes, using the Caltrans planning level ADT-based signal warrant analysis worksheets. Similarly, the speed limit has been used as the basis for determining the use of Urban and Rural warrants. Traffic signal warrant analyses were performed for the following study area intersection shown on Table 2-3:

**TABLE 2-3: TRAFFIC SIGNAL WARRANT ANALYSIS LOCATIONS**

#	Intersection
1	Harvill Av. & Driveway 1
2	Harvill Av. & America's Tire Dr.

The Existing conditions traffic signal warrant analysis is presented in the subsequent section, Section 3 Area Conditions of this report. The traffic signal warrant analyses for future conditions are presented in Section 5 EAP (2025) Traffic Conditions and Section 6 EAPC (2025) Traffic Conditions of this report. It is important to note that a signal warrant defines the minimum condition under which the installation of a traffic signal might be warranted. Meeting this threshold condition does not require that a traffic control signal be installed at a particular location, but rather, that other traffic factors and conditions be evaluated in order to determine whether the signal is truly justified. It should also be noted that signal warrants do not necessarily correlate with LOS. An intersection may satisfy a signal warrant condition and operate at or above acceptable LOS or operate below acceptable LOS and not meet a signal warrant.

## 2.4 QUEUING ANALYSIS

Consistent with Caltrans requirements, the 95<sup>th</sup> percentile queuing of vehicles has been assessed at the off-ramps to determine potential queuing deficiencies at the freeway ramp intersections at the I-215 Freeway at the existing Ramona Expressway interchange. Specifically, the off-ramp queuing analysis is utilized to identify any potential queuing and “spill back” onto the I-215 Freeway mainline from the off-ramps. The 95<sup>th</sup> percentile queue has also been utilized to assess the queues at Ramona Expressway to identify any potential queuing.

The traffic progression analysis tool and HCM intersection analysis program, Synchro, has been used to assess the potential deficiencies/needs of the intersections with traffic added from the proposed Project. Storage (turn-pocket) length recommendations at the ramps have been based upon the 95<sup>th</sup> percentile queue resulting from the Synchro progression analysis. The footnote from the Synchro output sheets indicates if the 95<sup>th</sup> percentile cycle exceeds capacity. Traffic is simulated for two complete cycles of the 95<sup>th</sup> percentile traffic in Synchro in order to account for the effects of spillover between cycles. In practice, the 95<sup>th</sup> percentile queue shown will rarely be exceeded and the queues shown with the footnote are acceptable for the design of storage bays. The 95<sup>th</sup> percentile queue is derived from the average queue plus 1.65 standard deviations.

## 2.5 MINIMUM ACCEPTABLE LEVELS OF SERVICE (LOS)

Minimum Acceptable LOS and associated definitions of intersection deficiencies has been obtained from each of the applicable surrounding jurisdictions.

### 2.5.1 COUNTY OF RIVERSIDE

The definition of an intersection deficiency has been obtained from the County of Riverside General Plan. Riverside County General Plan Policy C 2.1 states that the County will maintain the following County-wide target LOS:

The following minimum target levels of service have been designated for the review of development proposals in the unincorporated areas of Riverside County with respect to transportation impacts on roadways designated in the Riverside County Circulation Plan which are currently County maintained, or are intended to be accepted into the County maintained roadway system:

- LOS C shall apply to all development proposals in any area of the Riverside County not located within the boundaries of an Area Plan, as well as those areas located within the following Area Plans: REMAP, Eastern Coachella Valley, Desert Center, Palo Verde Valley, and those non-Community Development areas of the Elsinore, Lake Mathews/Woodcrest, Mead Valley and Temescal Canyon Area Plans.
- LOS D shall apply to all development proposals located within any of the following Area Plans: Eastvale, Jurupa, Highgrove, Reche Canyon/Badlands, Lakeview/Nuevo, Sun City/Menifee Valley, Harvest Valley/Winchester, Southwest Area, The Pass, San Jacinto Valley, Western Coachella Valley and those Community Development Areas of the Elsinore, Lake Mathews/Woodcrest, Mead Valley and Temescal Canyon Area Plans.
- LOS E may be allowed by the Board of Supervisors within designated areas where transit-oriented development and walkable communities are proposed.

The applicable minimum LOS utilized for the purposes of this analysis is LOS D per the County-wide target LOS for projects located within the Mead Valley Area Plan.

### 2.5.2 CITY OF PERRIS

Required LOS for roadway segments and intersections within the City of Perris is LOS D. An exception to the local road standard is LOS E, at intersections of any Arterials and Expressways with SR-74, the Ramona-Cajalco Expressway or at I-215 Freeway ramps. For the purposes of this traffic impact analysis, LOS D has also been considered the acceptable threshold for all intersections within the study area.

### 2.5.3 CALTRANS

Senate Bill 743 (SB 743), approved in 2013, endeavors to change the way transportation impacts will be determined according to the California Environmental Quality Act (CEQA). The Office of Planning and Research (OPR) has recommended the use of vehicle miles traveled (VMT) as the replacement for automobile delay-based LOS. Caltrans acknowledges automobile delay will no longer be considered a CEQA impact for development projects and will use VMT as the metric for determining impacts on



the State Highway System (SHS). However, LOS D has been utilized as the target LOS for Caltrans facilities, consistent with the County of Riverside.

## 2.6 DEFICIENCY CRITERIA

This section outlines the methodology used in this analysis related to identifying circulation system deficiencies. The following deficiency criteria has been utilized for the County of Riverside. To determine whether the addition of project-related traffic at a study intersection would result in a deficiency, the following will be utilized:

- A deficiency occurs at study area intersections if the pre-Project condition is at or better than LOS D (i.e., acceptable LOS), and the addition of project trips causes the peak hour LOS of the study area intersection to operate at unacceptable LOS (i.e., LOS E or F). Per the County of Riverside traffic study guidelines, for intersections currently operating at unacceptable LOS (LOS E or F), a deficiency will occur if the Project contributes peak hour trips to pre-project traffic conditions.

## 2.7 PROJECT FAIR SHARE CALCULATION METHODOLOGY

Improvements found to be included in the TUMF and/or DIF will be identified as such. For improvements that do not appear to be in either of the pre-existing fee programs, a fair share contribution based on the Project's proportional share may be imposed in order to address the Project's share of deficiencies in lieu of construction. It should be noted that fair share calculations are for informational purposes only and the County Traffic Engineer will determine the appropriate improvements to be implemented by a project (to be identified in the conditions of approval). The Project's fair share contribution is determined based on the following equations, which are the ratio of Project traffic to net new traffic (where net new traffic is the future traffic less existing traffic):

$$\text{Project Fair Share \%} = \text{Project (EAPC) Traffic} / (\text{EAPC Total Traffic} - \text{Existing Traffic})$$

### 3 AREA CONDITIONS

This section provides a summary of the existing circulation network, the County of Riverside General Plan Circulation Network, and a review of existing peak hour intersection operations, traffic signal warrant, and off-ramp queuing analyses.

#### 3.1 EXISTING CIRCULATION NETWORK

Pursuant to the scoping agreement with County of Riverside staff (Appendix 1.1), the study area includes a total of 5 existing and future intersections as shown previously on Exhibit 1-3, where the Project is anticipated to contribute 50 or more peak hour trips or were added at the County's request during the scoping process. Exhibit 3-1 illustrates the study area intersections located near the proposed Project and identifies the number of through traffic lanes for existing roadways and intersection traffic controls.

#### 3.2 COUNTY OF RIVERSIDE GENERAL PLAN CIRCULATION ELEMENT

As noted previously, the Project site is located within the County of Riverside. The roadway classifications and planned (ultimate) roadway cross-sections of the major roadways within the study area, as identified on County of Riverside General Plan Circulation Element, are described subsequently. Exhibit 3-2 shows the County of Riverside General Plan Circulation Element and Exhibit 3-3 illustrates the County of Riverside General Plan roadway cross-sections.

**Expressways** are six to eight-lane divided roadways (typically divided by a raised median) with a 220-foot right-of-way and a 134-foot curb-to-curb measurement. These roadways serve regional through-traffic. The following study area roadway within the County of Riverside is classified as an Expressway:

- Ramona Expressway/Cajalco Expressway

**Major Highways** are four-lane roadways and may include a painted median. These roadways typically have a 118-foot right-of-way and a 76-foot curb-to-curb measurement. These roadways typically direct traffic through major development areas. The following study area roadway within the County of Riverside is classified as a Major Highway:

- Harvill Avenue

**EXHIBIT 3-1: EXISTING NUMBER OF THROUGH LANES AND INTERSECTION CONTROLS**



1	Harvill Av. & Dwy. 1	2	Harvill Av. & America's Tire Dr.	3	Harvill Av. & Cajalco Expy	4	I-215 SB Ramps & Ramona Expy.	5	I-215 NB Ramps & Ramona Expy.
Future Intersection									

EXHIBIT 3-2: COUNTY OF RIVERSIDE GENERAL PLAN CIRCULATION ELEMENT

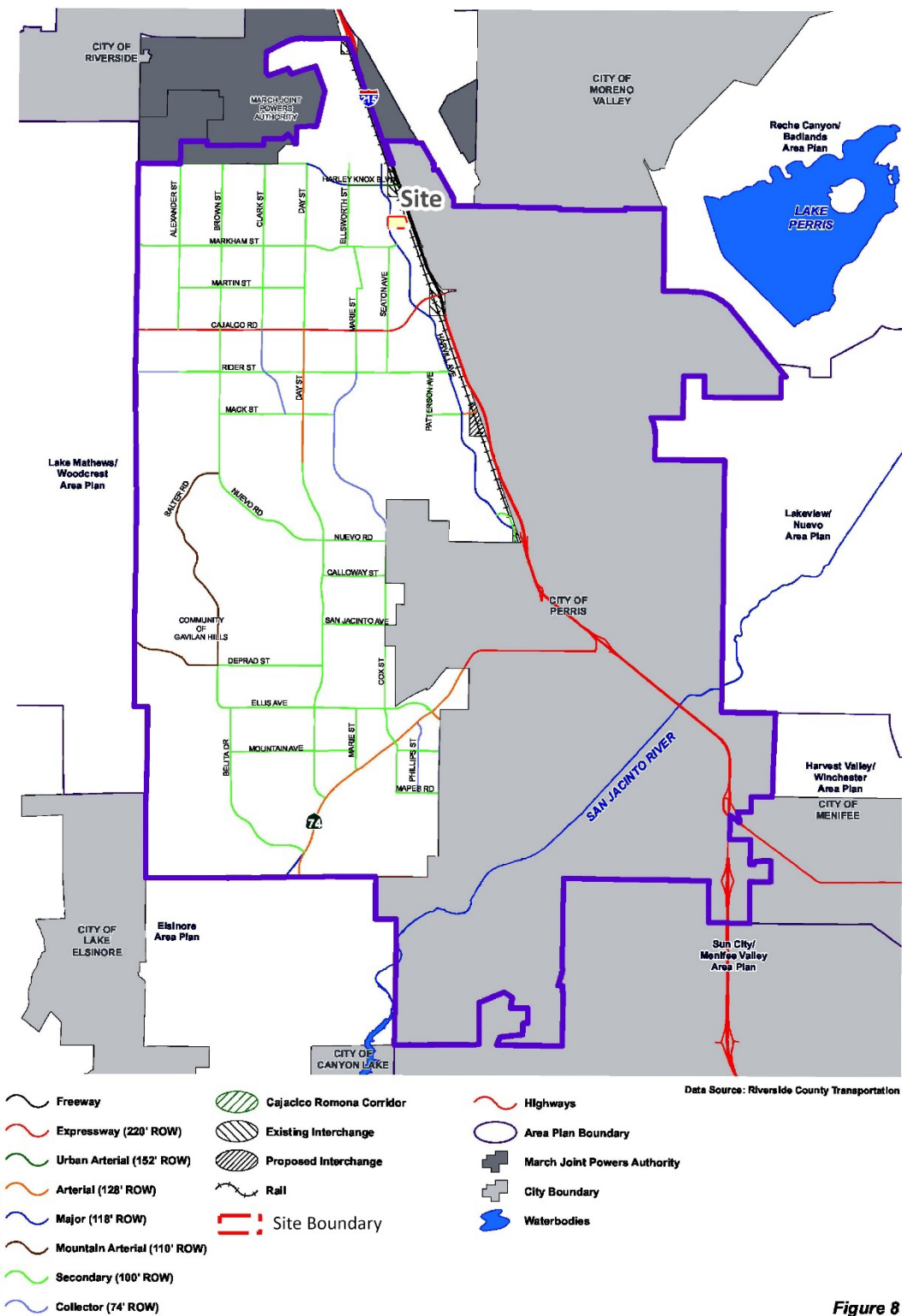
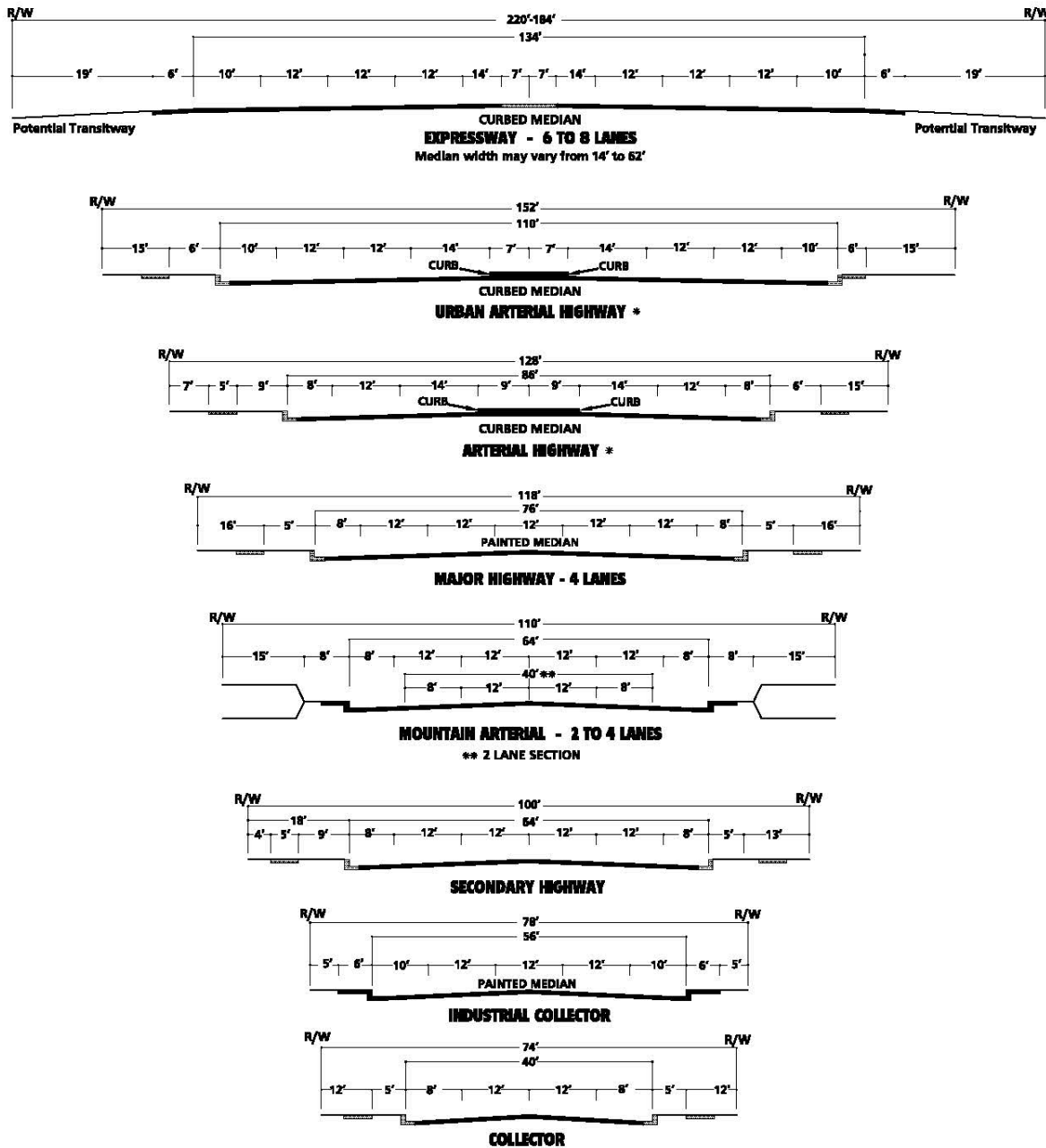

Figure 8

**EXHIBIT 3-3: COUNTY OF RIVERSIDE GENERAL PLAN ROADWAY CROSS-SECTIONS**



\* IMPROVEMENTS MAY BE RECONFIGURED TO ACCOMMODATE EXCLUSIVE TRANSIT LANES OR ALTERNATIVE LANE ARRANGEMENTS. ADDITIONAL RIGHT OF WAY MAY BE REQUIRED AT INTERSECTIONS TO ACCOMMODATE ULTIMATE IMPROVEMENTS FOR STATE HIGHWAYS. SHALL CONFORM TO CALTRANS DESIGN STANDARDS.

NOT TO SCALE

SOURCE: COUNTY OF RIVERSIDE  
 July 7, 2020

### 3.3 CITY OF PERRIS GENERAL PLAN CIRCULATION ELEMENT

Exhibits 3-4 and 3-5 show the City of Perris General Plan Circulation Element and roadway cross-sections, respectively.

### 3.4 BICYCLE & PEDESTRIAN FACILITIES

The County of Riverside and City of Perris bike networks are shown on Exhibit 3-6 and Exhibit 3-7, respectively. As shown on Exhibit 3-6, there is a planned Regional Trail (Urban/Suburban) trail proposed along Harvill Avenue south of the Project, a Community Trail along Harvill Avenue north of the Project and west of the Project along Martin Street, and a Class II (on-street, striped) bike lane along Ramona Expressway/Cajalco Expressway. Exhibit 3-8 illustrates the existing crosswalks throughout the study area. As shown on Exhibit 3-8, there are pedestrian facilities in place in the vicinity of the Project site on either side of Harvill Avenue near America's Tire Drive with the exception of America's Tire Drive along the north side of the roadway. Development of the proposed Project would connect to these existing pedestrian facilities to those to be constructed by the Project along its frontages on America's Tire Drive and Harvill Avenue.

### 3.5 TRANSIT SERVICE

The study area is currently served by Riverside Transit Agency (RTA) with bus service along the I-215 Freeway and Cajalco Expressway/Ramona Expressway. RTA Route 27 runs along the I-215 Freeway and stops at Perris High School (on Nuevo Road) and runs between the Perris Station Transit Center and the Galleria at Tyler in the City of Riverside. RTA Route 41 runs along Ramona/Cajalco Expressway and has existing bus stops to the west and east of Harvill Avenue, which is located approximately ¼ mile from the Project. There are currently no transit routes or stops along the Harvill Avenue corridor near the proposed Project. The transit services are illustrated on Exhibit 3-9. As shown, the closest existing transit route that could potentially serve the site is along Cajalco Expressway. Transit service is reviewed and updated by RTA periodically to address ridership, budget, and community demand needs. Changes in land use can affect these periodic adjustments which may lead to either enhanced or reduced service where appropriate.

### 3.6 TRUCK ROUTES

The County of Riverside's General Plan does not provide designated truck routes, and the City of Perris' truck routes are shown on Exhibit 3-10. Trucks are prohibited on certain County roadways through the Municipal Code through weight restrictions. Truck routes for the proposed Project have been determined based on discussions with County staff and takes into consideration the approved truck routes within the adjacent City of Perris. These truck routes serve both the proposed Project and future cumulative development projects throughout the study area. Sensitive land uses have also been taken into consideration as part of determining the best routes for future trucks.



EXHIBIT 3-4: CITY OF PERRIS GENERAL PLAN CIRCULATION ELEMENT

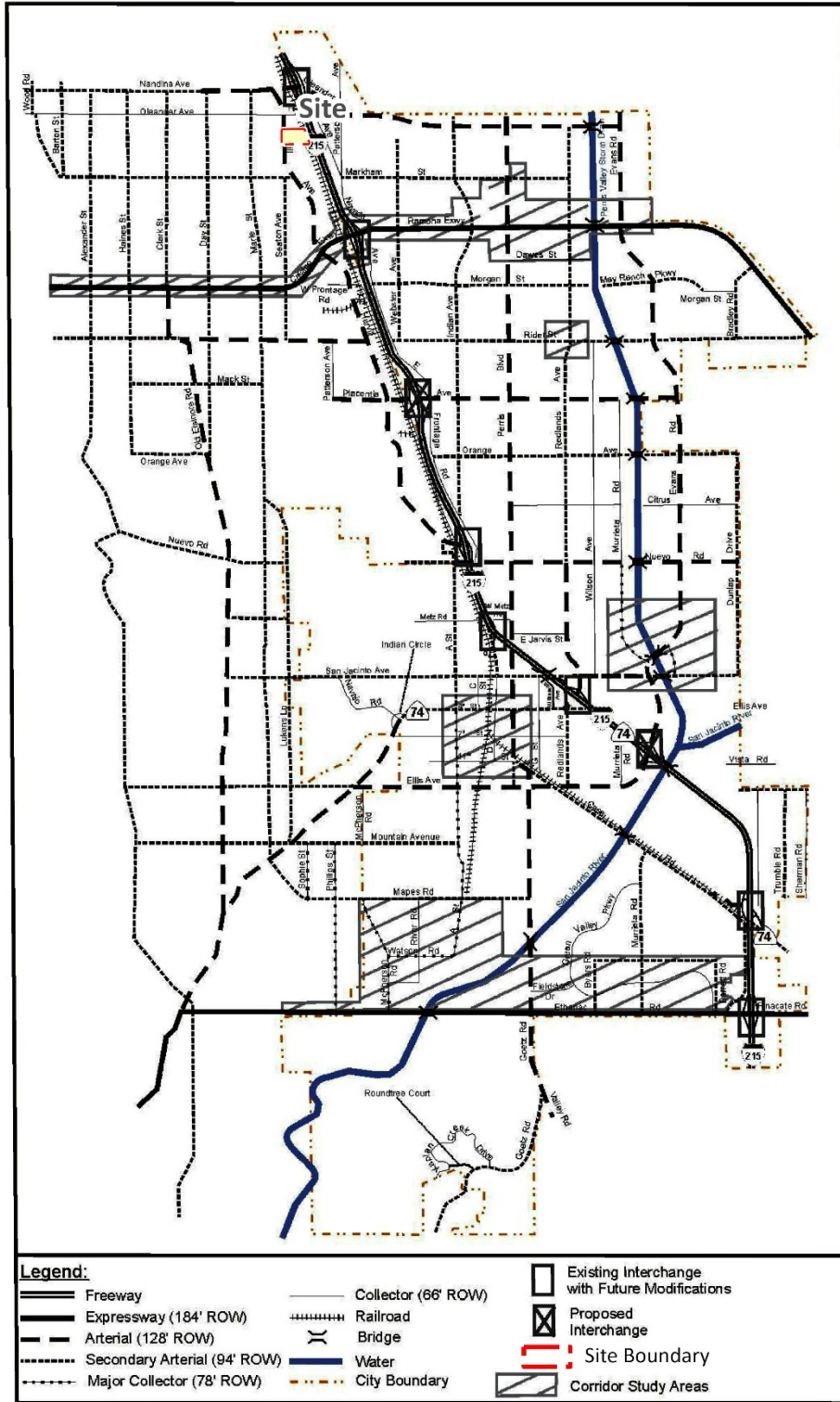

**EXHIBIT 3-5: CITY OF PERRIS GENERAL PLAN ROADWAY CROSS-SECTIONS**

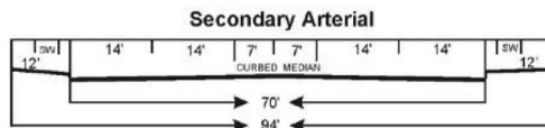
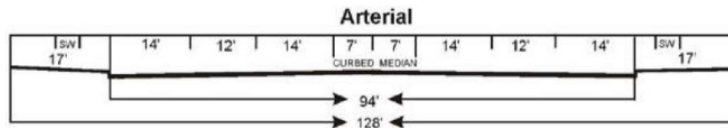
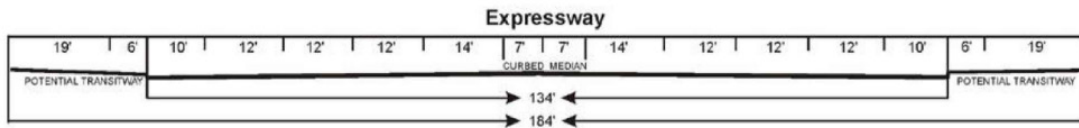

or

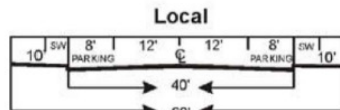
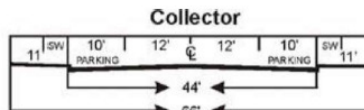
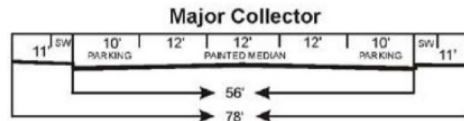
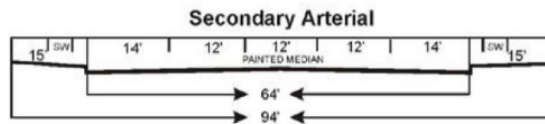

Specific details for each cross-section follow in Figures 4.1 A - 4.1 F

**Legend**

- SW Sidewalk or Trail (at least 4 feet)
- PARKING Parking or Bike Lane
- PAINTED MEDIAN Center Median and/or Continuous Left Turning Lane
- CURBED MEDIAN Landscaped Center Median

Source: City of Perris  
General Plan  
1-11-2022



EXHIBIT 3-6: COUNTY OF RIVERSIDE GENERAL PLAN BIKE NETWORK

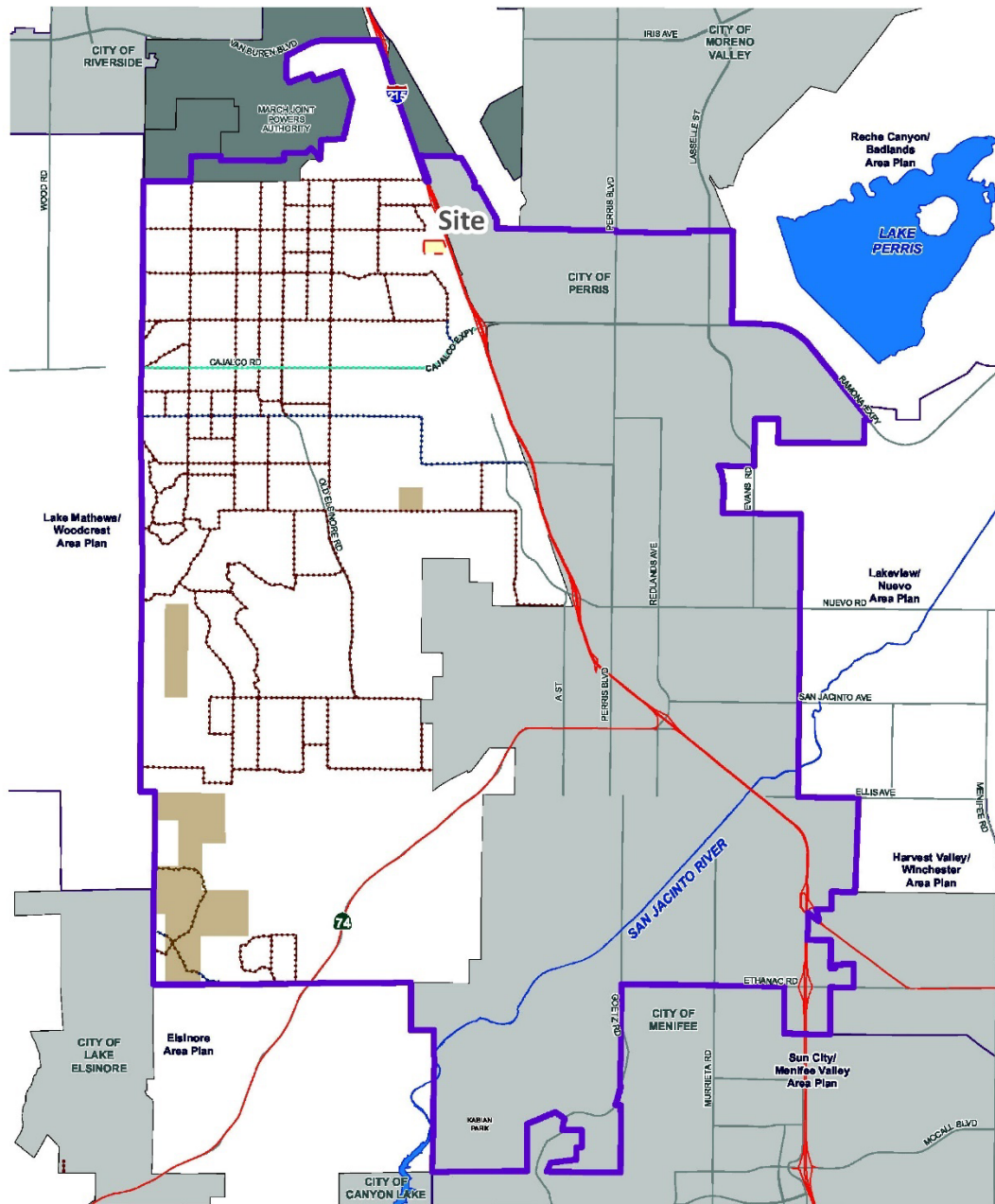

Data Source: Riverside County Parks

- Regional Trail: Urban/Suburban
- Community Trail
- Class II Bike Path
- Non-County Trail (Public and Quasi-Public Lands)
- Site Boundary
- Highways
- Area Plan Boundary
- March Joint Powers Authority
- City Boundary
- Waterbodies
- Bureau of Land Management (BLM) Lands

Note: Trails shown in open severity jurisdictions for future trail construction purposes only.  
 Data Source: Riverside County Regional Park and Open Space District, all boundaries from Riverside County GIS/Information Services Department, Riverside County Parks and Development Agency, and other local, state, and federal governmental agencies.  
 Note: Trails and planning maps are a graphic representation of the general location and character of existing and proposed trails and bikeways in the unincorporated area of the County. All questions regarding general information or technical information should be referred to the Riverside County Planning and Open Space District.  
 Note: Except for single regional trails, trails and bikeways systems located within cities are generally within city limits and are subject to city planning and development. All questions regarding general information or technical information should be referred to the appropriate local government agency. To a maximum extent possible, the appropriate local government agency should be contacted for all information about the city's existing, planned trails and bikeways systems.

Figure 9

EXHIBIT 3-7: CITY OF PERRIS BIKE PLAN



EXHIBIT 3-8: EXISTING PEDESTRIAN FACILITIES

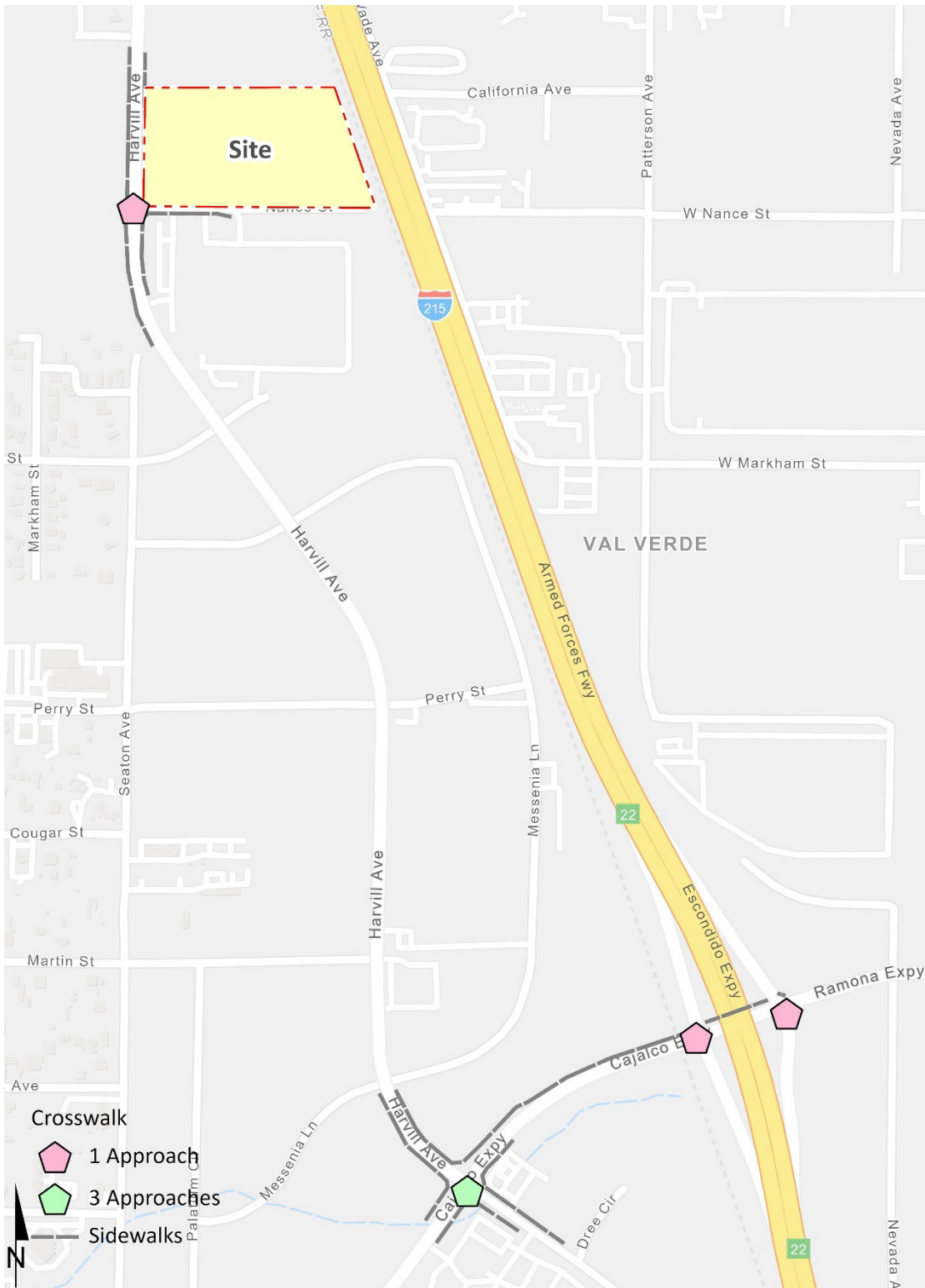



EXHIBIT 3-9: EXISTING TRANSIT ROUTES

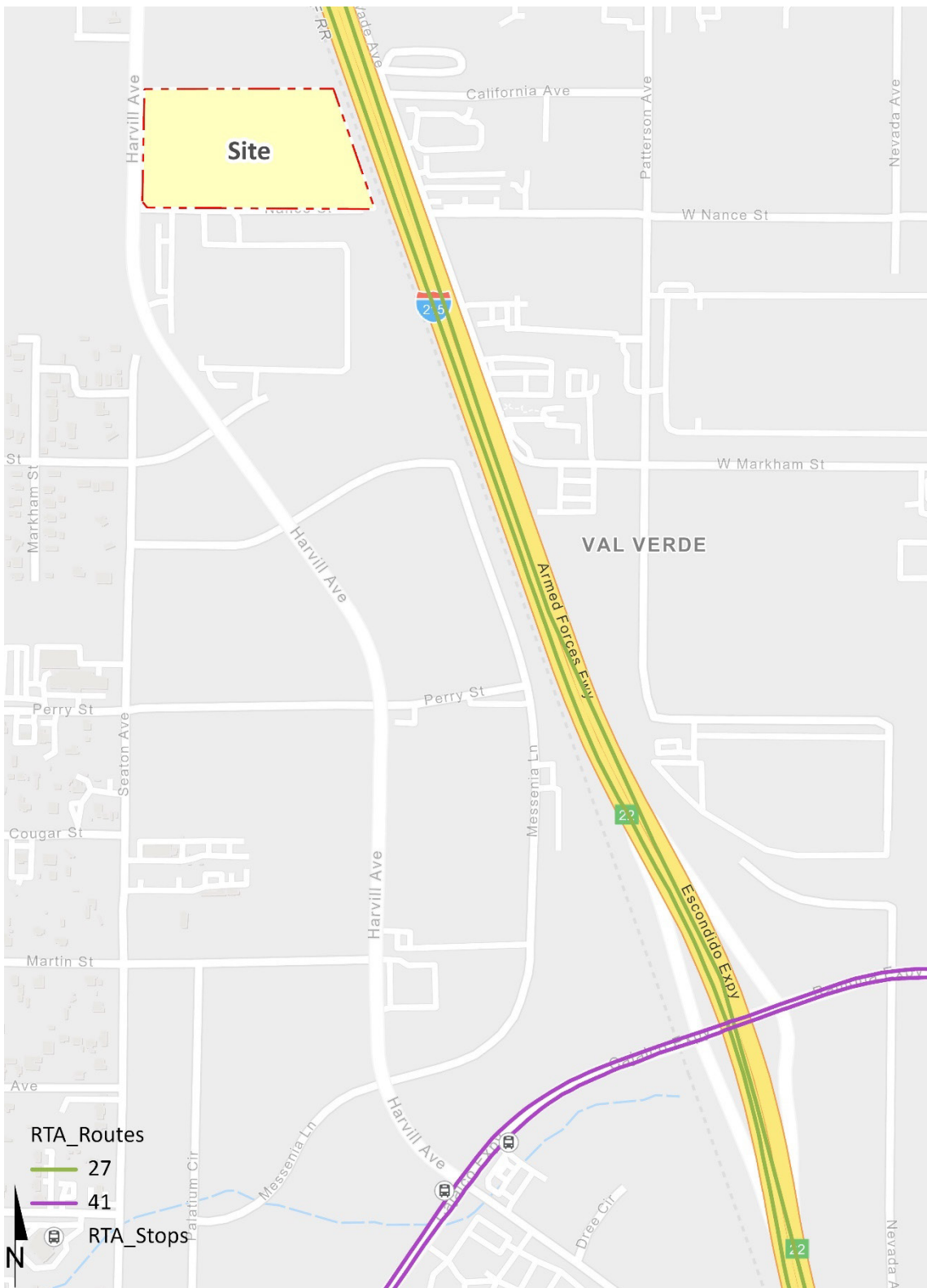
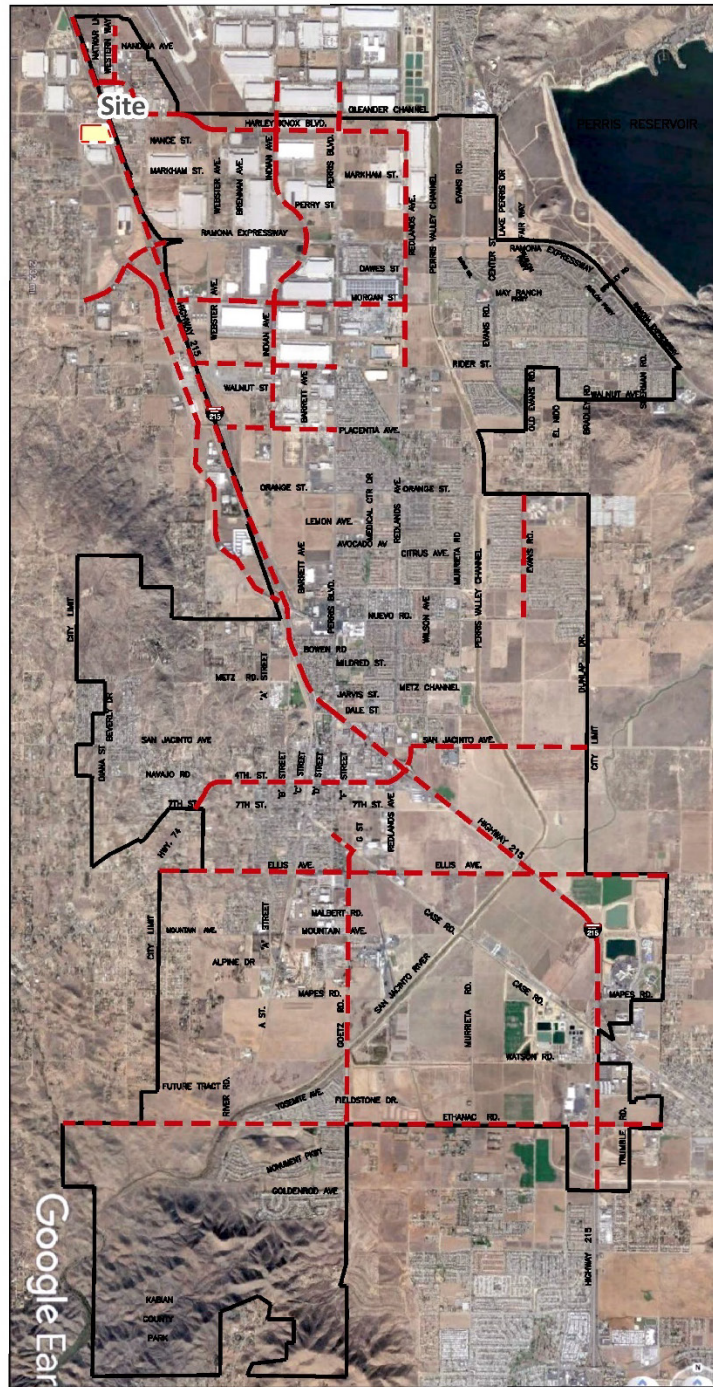

EXHIBIT 3-10: CITY OF PERRIS TRUCK ROUTES

**CITY OF PERRIS TRUCK ROUTES**  
 CITY COUNCIL APPROVED JANUARY 11TH, 2022 - EFFECTIVE FEBRUARY 10TH, 2022



**LEGEND:**

- TRUCK ROUTES
- PERRIS CITY LIMITS
- Site Boundary



### 3.7 EXISTING (2022) TRAFFIC COUNTS

The intersection LOS analysis is based on the traffic volumes observed during the peak hour conditions using traffic count data collected in January and February 2022 when local schools were in session and operating on normal bell schedules. The following peak hours were selected for analysis:

- Weekday AM Peak Hour (peak hour between 7:00 AM and 9:00 AM)
- Weekday PM Peak Hour (peak hour between 4:00 PM and 6:00 PM)

There were no observations made in the field that would indicate atypical traffic conditions on the count dates, such as construction activity or detour routes and near-by schools were in session and operating on normal schedules. The raw manual peak hour turning movement traffic count data sheets are included in Appendix 3.1.

Existing weekday ADT volumes on arterial highways throughout the study area are shown on Exhibit 3-11. Existing ADT volumes were based upon factored intersection peak hour counts collected by Urban Crossroads, Inc. using the following formula for each intersection leg:

$$\text{Weekday PM Peak Hour (Approach Volume + Exit Volume)} \times 14.29 = \text{Leg Volume}$$

A comparison of the PM peak hour and daily traffic volumes of various roadway segments within the study area indicated that the peak-to-daily relationship is approximately 7.0 percent. As such, the above equation utilizing a factor of 14.29 estimates the ADT volumes on the study area roadway segments assuming a peak-to-daily relationship of approximately 7.0 percent (i.e.,  $1/0.07 = 14.29$ ) and was assumed to sufficiently estimate ADT volumes for planning-level analyses. This factor is consistent with that used for other traffic studies within the study area. Existing weekday AM and weekday PM peak hour intersection volumes are shown on Exhibit 3-11.

Volumes reported on the exhibits are expressed in actual vehicles. However, consistent with the County's guidelines, the peak hour intersection operations analysis utilizes passenger car equivalent (PCE) volumes. PCEs allow the typical "real-world" mix of vehicle types to be represented as a single, standardized unit, such as the passenger car, to be used for the purposes of capacity and level of service analyses. The PCE factors are consistent with the recommended PCE factors in the County's Guidelines. PCE volumes can be found in Appendix 3.1.

**EXHIBIT 3-11: EXISTING (2022) TRAFFIC VOLUMES**

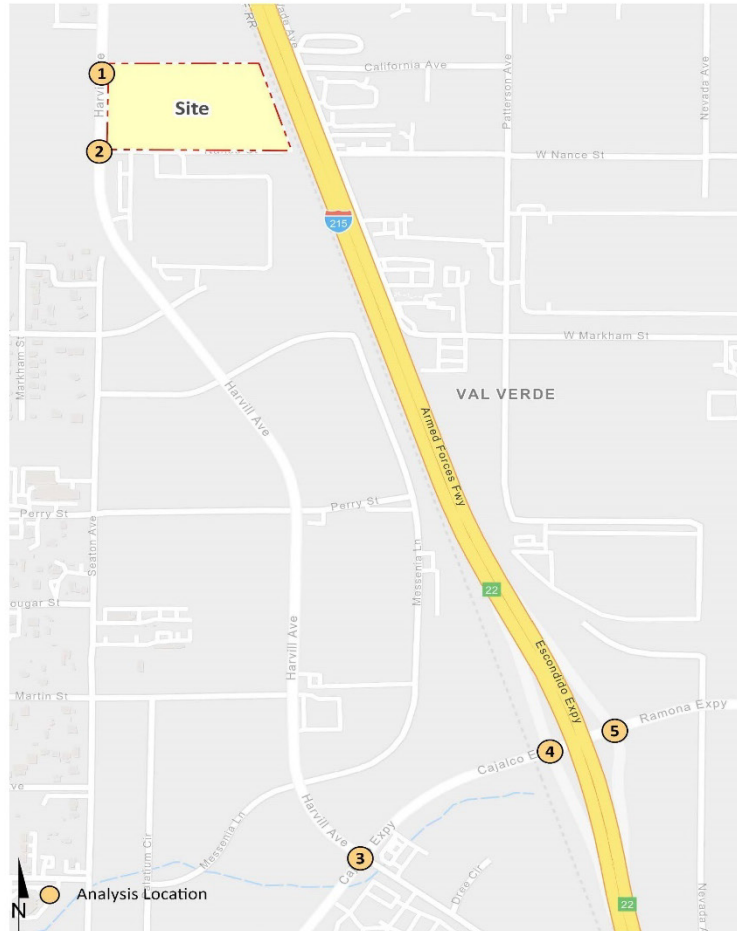

<b>1 Harvill Av. &amp; Driveway 1</b> 8,450 251(322) 410(339) 8,450		<b>2 Harvill Av. &amp; America's Tire Dr.</b> 8,450 248(322) 3(0) 0(6) 410(333) 0(1) 9,350		<b>3 Harvill Av. &amp; Cajalco Exwy.</b> 10,850 19(32) 102(200) 174(218) 37(22) 626(686) 48(200) 285(159) 328(140) 65(116) 27,050 13,100	
<b>4 I-215 SB Ramps &amp; Ramona Exwy.</b> 12,850 144(135) 1(4) 619(760) 943(821) 281(346) 650(820) 307(323) 39,250 9,600		<b>5 I-215 NB Ramps &amp; Ramona Exwy.</b> 9,800 599(583) 910(848) 100(100) 1169(1480) 314(319) 3(3) 552(425) 47,650 10,650			

##(##) AM(PM) Peak Hour Intersection Volumes  
 ## Average Daily Trips



### 3.8 INTERSECTION OPERATIONS ANALYSIS

Existing peak hour traffic operations have been evaluated for the study area intersections based on the analysis methodologies presented in Section 2.2 Intersection Capacity Analysis of this report. The intersection operations analysis results are summarized on Table 3-1, which indicates that all existing study area intersections are currently operating at acceptable LOS during the peak hours. The intersection operations analysis worksheets are included in Appendix 3.2 of this TA.

**TABLE 3-1: INTERSECTION ANALYSIS FOR EXISTING (2022) CONDITIONS**

# Intersection	Traffic Control <sup>2</sup>	Delay <sup>1</sup> (secs.)		Level of Service	
		AM	PM	AM	PM
1 Harvill Av. & Driveway 1		Future Intersection			
2 Harvill Av. & America's Tire Dr.	CSS	8.3	9.4	A	A
3 Harvill Av. & Cajalco Exwy.	TS	38.4	37.8	D	D
4 I-215 SB Ramps & Ramona Exwy.	TS	36.7	43.9	D	D
5 I-215 NB Ramps & Ramona Exwy.	TS	25.5	18.4	C	B

<sup>1</sup> Per the Highway Capacity Manual (6th Edition), overall average intersection delay and level of service are shown for intersections with a traffic signal or all way stop control. For intersections with cross street stop control, the delay and level of service for the worst individual movement (or movements sharing a single lane) are shown. HCM delay reported in seconds.

<sup>2</sup> TS = Traffic Signal; CSS = Cross-street Stop

### 3.9 TRAFFIC SIGNAL WARRANTS ANALYSIS

Traffic signal warrants for Existing traffic conditions are based on existing peak hour intersection turning volumes. There are no unsignalized study area intersections that currently warrant a traffic signal for Existing traffic conditions. Existing conditions traffic signal warrant analysis worksheets are provided in Appendix 3.3.

### 3.10 QUEUING ANALYSIS

A queuing analysis was performed for the off-ramps at the I-215 Freeway at Ramona Expressway interchange. Queuing analysis findings are presented in Table 3-2. It is important to note that off-ramp lengths are consistent with the measured distance between the intersection and the freeway mainline. As shown in Table 3-2, there are no movements that are currently experiencing queuing issues during the weekday AM or weekday PM peak 95<sup>th</sup> percentile traffic flows. Worksheets for Existing (2022) traffic conditions off-ramp queuing analysis are provided in Appendix 3.4.



**TABLE 3-2: PEAK HOUR QUEUING SUMMARY FOR EXISTING (2022) CONDITIONS**

Intersection	Movement	Available Stacking Distance (Feet)	95th Percentile Queue (Feet)		Acceptable? <sup>1</sup>	
			AM Peak Hour	PM Peak Hour	AM	PM
I-215 SB Ramps & Ramona Exwy.	SBL	530	445 <sup>2</sup>	468 <sup>2</sup>	Yes	Yes
	SBT	1,100	448 <sup>2</sup>	481 <sup>2</sup>	Yes	Yes
	SBR	530	138	78	Yes	Yes
I-215 NB Ramps & Ramona Exwy.	NBL	520	184	176	Yes	Yes
	NBT	1,120	187	181	Yes	Yes
	NBR	520	685 <sup>2,3</sup>	457 <sup>2</sup>	Yes	Yes

<sup>1</sup> Stacking Distance is acceptable if the required stacking distance is less than or equal to the stacking distance provided. An additional 25 feet of stacking which is assumed to be provided in the transition for turn pockets is reflected in the stacking distance shown on this table, where applicable.

<sup>2</sup> 95th percentile volume exceeds capacity, queue may be longer. Queue shown is maximum after two cycles.

<sup>3</sup> Although 95th percentile queue is anticipated to exceed the available storage for the turn lane, the adjacent through lane has sufficient storage to accommodate any spillover without spilling back and affecting the I-215 Freeway mainline.

## 4 PROJECTED FUTURE TRAFFIC

This section presents the traffic volumes estimated to be generated by the Project, as well as the Project's trip assignment onto the study area roadway network. The proposed Project building is 256,148 square feet of building space, however, in an effort to conduct a conservative analysis a 266,955 square foot warehouse building has been evaluated in order to account for any future minor revisions in building size. For the purposes of this TA, the building has been evaluated assuming high-cube short-term storage and transload warehouse use. Access to the Project site will be accommodated via Harvill Avenue and America's Tire Drive. Regional access to the Project site is available from the I-215 Freeway via the existing Harley Knox Boulevard and Ramona Expressway interchanges.

### 4.1 PROJECT TRIP GENERATION

#### 4.1.1 PROPOSED PROJECT TRIP GENERATION

Trip generation represents the amount of traffic which is both attracted to and produced by a development. Determining traffic generation for a specific project is therefore based upon forecasting the amount of traffic that is expected to be both attracted to and produced by the specific land uses being proposed for a given development. In order to develop the traffic characteristics of the proposed project, trip-generation statistics published in the ITE Trip Generation Manual (11<sup>th</sup> Edition, 2021) was used to calculate the trip generation. (2) The following trip generation rates and vehicle mix were utilized for calculating the trip generation for the proposed Project:

- ITE land use code 154 (High-Cube Transload and Short-Term Storage Warehouse) has been used to derive site specific trip generation estimates for the Project. High-cube transload/short-term storage warehouse data regarding the truck percentage and vehicle mix has also been obtained from the latest Trip Generation Manual. The SCAQMD recommended truck mix, by axle type for high-cube warehouses has been utilized for the 2-axle, 3-axle, and 4+-axle trucks: 2-Axle = 16.7%; 3-Axle = 20.7%; 4+-Axle = 62.6%.

PCE factors were applied to the trip generation rates for heavy trucks (large 2-axles, 3-axles, 4+-axles). PCEs allow the typical "real-world" mix of vehicle types to be represented as a single, standardized unit, such as the passenger car, to be used for the purposes of capacity and LOS analyses. The PCE factors are consistent with the recommended PCE factors In the County's Guidelines. Trip generation rates are summarized on Table 4-1 for actual vehicles and PCE.

**TABLE 4-1: TRIP GENERATION RATES**

Land Use <sup>1</sup>	Units <sup>2</sup>	ITE LU Code	AM Peak Hour			PM Peak Hour			Daily
			In	Out	Total	In	Out	Total	
<b>Actual Vehicle Trip Generation Rates</b>									
High-Cube Transload and Short-Term Storage	TSF	154	0.062	0.018	0.080	0.028	0.072	0.100	1.400
Passenger Cars			0.052	0.008	0.060	0.023	0.067	0.090	1.180
2-Axle Trucks			0.002	0.001	0.003	0.001	0.001	0.002	0.037
3-Axle Trucks			0.002	0.002	0.004	0.001	0.001	0.002	0.046
4+-Axle Trucks			0.006	0.007	0.013	0.003	0.003	0.006	0.138
<b>Passenger Car Equivalent (PCE) Trip Generation Rates<sup>4</sup></b>									
High-Cube Transload and Short-Term Storage	TSF	154	0.062	0.018	0.080	0.028	0.072	0.100	1.400
Passenger Cars			0.052	0.008	0.060	0.023	0.067	0.090	1.180
2-Axle Trucks (PCE = 1.5)			0.003	0.002	0.005	0.002	0.001	0.003	0.055
3-Axle Trucks (PCE = 2.0)			0.004	0.004	0.008	0.002	0.002	0.004	0.091
4+-Axle Trucks (PCE = 3.0)			0.018	0.020	0.038	0.009	0.010	0.019	0.413

<sup>1</sup> Trip Generation & Vehicle Mix Source: Institute of Transportation Engineers (ITE), Trip Generation Manual, Eleventh Edition (2021).

<sup>2</sup> TSF = thousand square feet

<sup>3</sup> Truck Mix: South Coast Air Quality Management District's (SCAQMD) recommended truck mix, by axle type.

Normalized % - Without Cold Storage: 16.7% 2-Axle trucks, 20.7% 3-Axle trucks, 62.6% 4-Axle trucks.

<sup>4</sup> PCE factors: 2-axle = 1.5; 3-axle = 2.0; 4+-axle = 3.0.

Per the County's Guidelines, peak hour intersection operations analyses are to utilize the PCE trip generation. The trip generation summary illustrating daily and peak hour trip generation estimates for the Project in actual vehicles are shown on Table 4-2. The proposed Project is anticipated to generate 378 two-way trip-ends per day with 23 AM peak hour trips and 26 PM peak hour trips (see Table 4-2, in actual vehicles). PCE based trip generation for the Project are also summarized on Table 4-2.

**TABLE 4-2: PROJECT TRIP GENERATION SUMMARY**

Land Use	Quantity Units <sup>1</sup>	AM Peak Hour			PM Peak Hour			Daily
		In	Out	Total	In	Out	Total	
<b>Actual Vehicles:</b>								
High-Cube Short-Term Storage/Transload	268.955 TSF							
Passenger Cars:		14	2	16	6	18	24	318
2-axle Trucks:		1	0	1	0	0	0	10
3-axle Trucks:		1	1	2	0	0	0	12
4+-axle Trucks:		2	2	4	1	1	2	38
Total Truck Trips (Actual Vehicles):		4	3	7	1	1	2	60
<b>Total Trips (Actual Vehicles)<sup>2</sup></b>		<b>18</b>	<b>5</b>	<b>23</b>	<b>7</b>	<b>19</b>	<b>26</b>	<b>378</b>
<b>Passenger Car Equivalent (PCE):</b>								
High-Cube Short-Term Storage/Transload	268.955 TSF							
Passenger Cars:		14	2	16	6	18	24	318
2-axle Trucks:		1	1	2	0	0	0	16
3-axle Trucks:		1	1	2	1	1	2	24
4+-axle Trucks:		5	5	10	2	3	5	112
Total Truck Trips (PCE):		7	7	14	3	4	7	152
<b>Total Trips (PCE)<sup>2</sup></b>		<b>21</b>	<b>9</b>	<b>30</b>	<b>9</b>	<b>22</b>	<b>31</b>	<b>470</b>

<sup>1</sup> TSF = thousand square feet

<sup>2</sup> Total Trips = Passenger Cars + Truck Trips.

## 4.2 PROJECT TRIP DISTRIBUTION

The Project trip distribution represents the directional orientation of traffic to and from the Project site. Trip distribution is the process of identifying the probable destinations, directions or traffic routes that will be utilized by Project traffic. The potential interaction between the planned land uses and surrounding regional access routes are considered, to identify the route where the Project traffic would distribute. In addition, truck routes for neighboring agencies have been taken into consideration in the development of the trip distribution patterns for heavy trucks. Exhibits 4-1 and 4-2 show the Project truck and passenger car trip distribution patterns, respectively. Note that the Project Truck distribution shows two alternatives that have been evaluated in this TA.

## 4.3 MODAL SPLIT

The potential for Project trips (non-truck) to be reduced by the use of public transit, walking or bicycling have not been included as part of the Project’s estimated trip generation. Essentially, the Project’s traffic projections are "conservative" in that these alternative travel modes would reduce the forecasted traffic volumes.

EXHIBIT 4-1: PROJECT (TRUCK) TRIP DISTRIBUTION



**EXHIBIT 4-2: PROJECT (PASSENGER CAR) TRIP DISTRIBUTION**

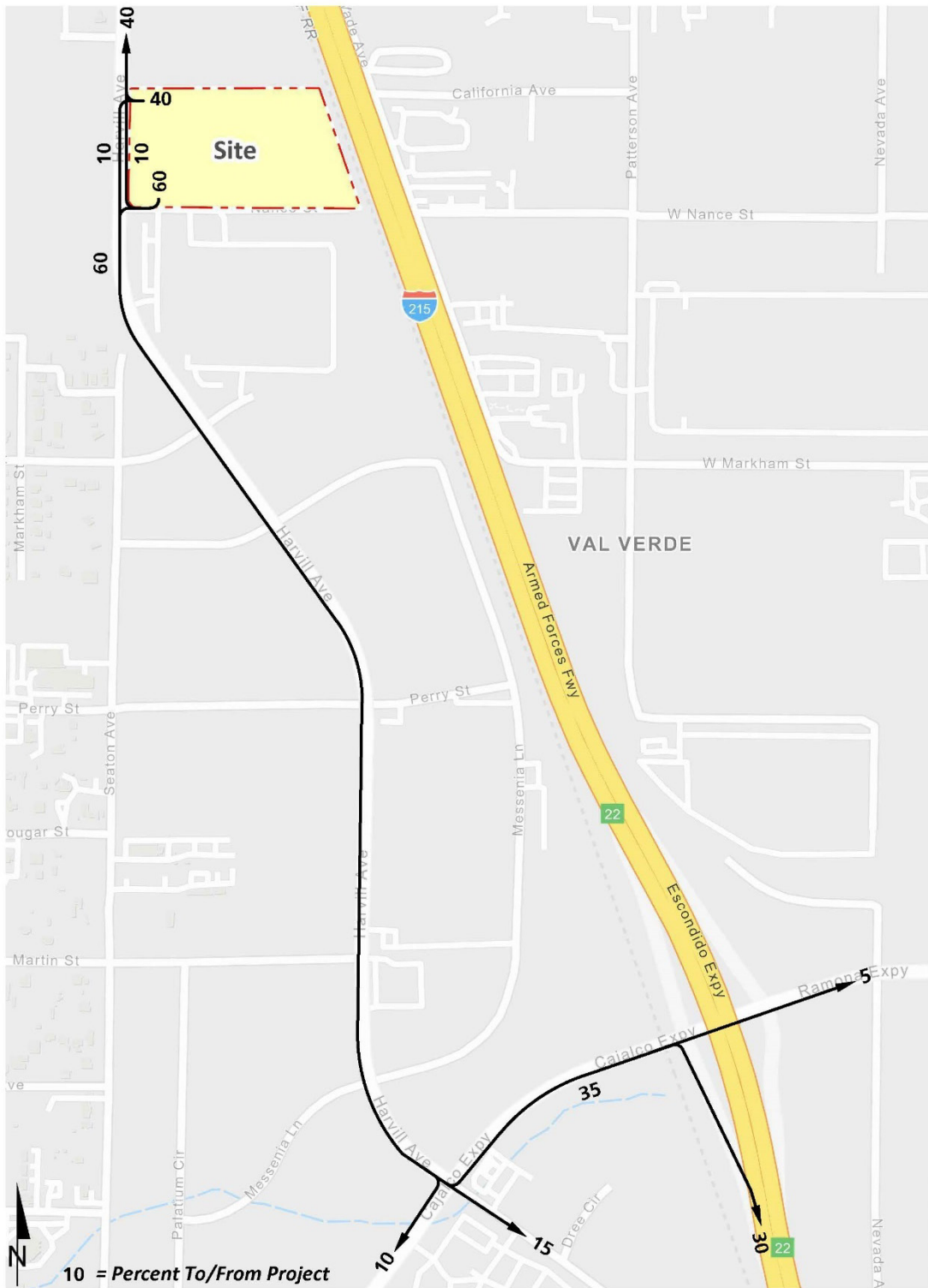

#### 4.4 PROJECT TRIP ASSIGNMENT

The assignment of traffic from the Project area to the adjoining roadway system is based upon the Project trip generation, trip distribution, and the arterial highway and local street system improvements that would be in place by the time of initial occupancy of the Project. Based on the identified Project traffic generation and trip distribution patterns, the Project only ADT and peak hour intersection turning movement volumes are shown on Exhibit 4-3.

#### 4.5 BACKGROUND TRAFFIC

Future year traffic forecasts have been based upon background (ambient) growth at 2% per year, compounded annually, for 2025 conditions. The total ambient growth is 6.12% for 2025 traffic conditions (compounded growth of 2 percent per year over 3 years or  $1.02^{3\text{years}}$ ). The ambient growth factor is intended to approximate regional traffic growth. This ambient growth rate is added to existing traffic volumes to account for area-wide growth not reflected by cumulative development projects. Ambient growth has been added to daily and peak hour traffic volumes on surrounding roadways, in addition to traffic generated by the development of future projects that have been approved but not yet built and/or for which development applications have been filed and are under consideration by governing agencies.

The currently adopted Southern California Association of Governments (SCAG) 2020 Regional Transportation Plan/Sustainable Communities Strategy (RTP/SCS) growth forecasts for the County of Riverside identifies projected growth in population of 370,500 in 2016 to 525,600 in 2045, or a 41.9 percent increase over the 29-year period. (6) The change in population equates to roughly a 1.21 percent growth rate, compounded annually. Similarly, growth over the same 29-year period in households is projected to increase by 59.2 percent, or 1.62 percent annual growth rate. Finally, growth in employment over the same 29-year period is projected to increase by 83.4 percent, or a 2.11 percent annual growth rate. This results in an average of 1.65 percent annual growth rate. As such, the 2.0 percent per year ambient growth rate utilized in this TA would appear to conservatively estimate annual traffic growth and overstate as opposed to understate future traffic forecasts.

EXHIBIT 4-3: PROJECT ONLY TRAFFIC VOLUMES

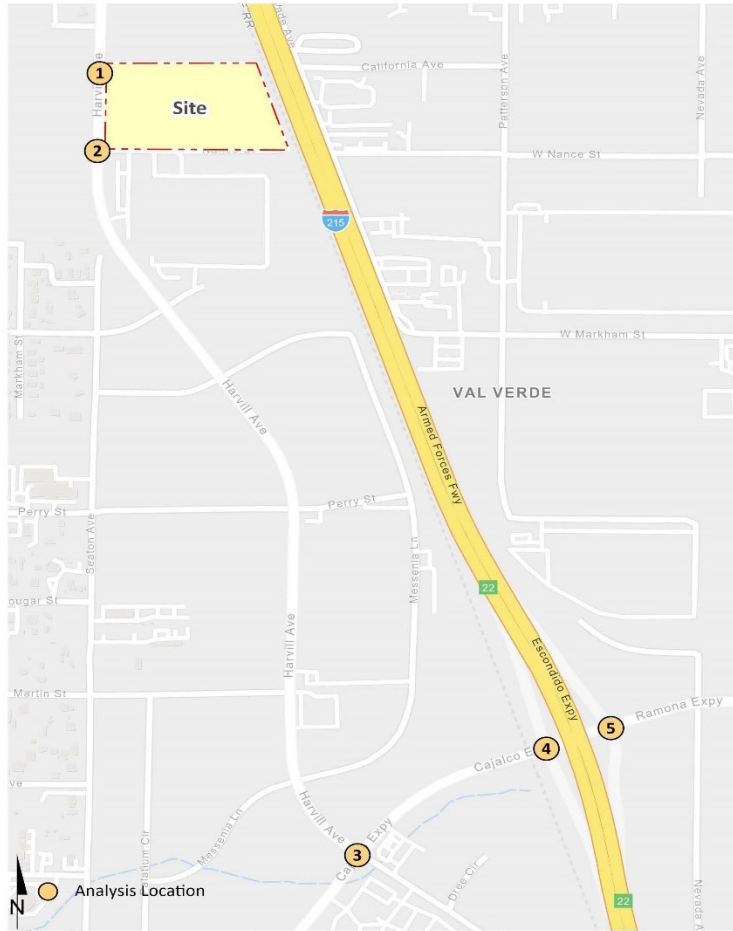

1	Harvill Av. & Driveway 1	2	Harvill Av. & America's Tire Dr.	3	Harvill Av. & Cajalco Expy.																											
150	<table border="1"> <tr> <td>← 4(1)</td> <td>↙ 4(2)</td> <td>↑ 1(5)</td> </tr> <tr> <td></td> <td>↑ 0(2)</td> <td>↘ 2(3)</td> </tr> <tr> <td></td> <td>↘ 1(1)</td> <td>↖ 1(1)</td> </tr> </table>	← 4(1)	↙ 4(2)	↑ 1(5)		↑ 0(2)	↘ 2(3)		↘ 1(1)	↖ 1(1)	150	<table border="1"> <tr> <td>← 0(2)</td> <td>↙ 4(1)</td> <td>↑ 2(3)</td> </tr> <tr> <td></td> <td>↑ 2(9)</td> <td>↘ 1(1)</td> </tr> <tr> <td></td> <td>↘ 8(3)</td> <td>↖ 2(1)</td> </tr> </table>	← 0(2)	↙ 4(1)	↑ 2(3)		↑ 2(9)	↘ 1(1)		↘ 8(3)	↖ 2(1)	250	<table border="1"> <tr> <td>↘ 0(2)</td> <td>↙ 0(3)</td> <td>↖ 1(7)</td> </tr> <tr> <td></td> <td>↘ 1(1)</td> <td>↖ 6(2)</td> </tr> <tr> <td></td> <td>↘ 2(1)</td> <td></td> </tr> </table>	↘ 0(2)	↙ 0(3)	↖ 1(7)		↘ 1(1)	↖ 6(2)		↘ 2(1)	
← 4(1)	↙ 4(2)	↑ 1(5)																														
	↑ 0(2)	↘ 2(3)																														
	↘ 1(1)	↖ 1(1)																														
← 0(2)	↙ 4(1)	↑ 2(3)																														
	↑ 2(9)	↘ 1(1)																														
	↘ 8(3)	↖ 2(1)																														
↘ 0(2)	↙ 0(3)	↖ 1(7)																														
	↘ 1(1)	↖ 6(2)																														
	↘ 2(1)																															
		100		200	Nominal																											
					Nominal																											
4	I-215 SB Ramps & Ramona Expy.	5	I-215 NB Ramps & Ramona Expy.																													
	<table border="1"> <tr> <td>← 6(2)</td> <td></td> </tr> <tr> <td>0(1) →</td> <td></td> </tr> <tr> <td>1(6) ↘</td> <td></td> </tr> </table>	← 6(2)		0(1) →		1(6) ↘		Nominal	<table border="1"> <tr> <td>← 1(0)</td> <td></td> </tr> <tr> <td>0(1) →</td> <td></td> </tr> <tr> <td></td> <td>↘ 5(2)</td> </tr> </table>	← 1(0)		0(1) →			↘ 5(2)	Nominal	Nominal															
← 6(2)																																
0(1) →																																
1(6) ↘																																
← 1(0)																																
0(1) →																																
	↘ 5(2)																															
150		Nominal		Nominal																												

##(##) AM(PM) Peak Hour Intersection Volumes  
 ## Average Daily Trips



## 4.6 CUMULATIVE DEVELOPMENT TRAFFIC

A cumulative project list was developed for the purposes of this analysis through consultation with planning and engineering staff from the County of Riverside. The cumulative project list includes known and foreseeable projects that are anticipated to contribute traffic to the study area intersections.

Where applicable, cumulative projects anticipated to contribute measurable traffic (i.e., 50 or more peak hour trips) to study area intersections have been manually added to the study area network to generate EAPC forecasts. In other words, this list of cumulative development projects has been reviewed to determine which projects would likely contribute measurable traffic through the study area intersections (e.g., those cumulative projects in close proximity to the proposed Project). For the purposes of this analysis, the cumulative projects that were determined to affect one or more of the study area intersections are shown on Exhibit 4-4, listed in Table 4-3, and have been considered for inclusion. Any additional traffic generated by other projects not on the cumulative projects list is likely accounted for through background ambient growth factors that have been applied to the peak hour volumes at study area intersections as discussed in Section 4.5 Background Traffic. Cumulative development projects shown in Exhibit 4-4 and listed in Table 4-3. Cumulative Only ADT and peak hour intersection turning movement volumes are shown on Exhibit 4-5.

## 4.7 NEAR-TERM TRAFFIC CONDITIONS

The “buildup” approach combines existing traffic counts with a background ambient growth factor to forecast EAP (2025) and EAPC (2025) traffic conditions. An ambient growth factor accounts for background (area-wide) traffic increases that occur over time up to the year 2025 from the year 2022. Traffic volumes generated by the Project are then added to assess the near-term traffic conditions. The 2025 roadway network is similar to the Existing conditions roadway network, with the exception of future driveways proposed to be developed by the Project. The near-term traffic analysis includes the following traffic conditions, with the various traffic components:

- Existing Plus Ambient Growth Plus Project (2025)
  - Existing 2022 counts
  - Ambient growth traffic (6.12%)
  - Project traffic
- Existing Plus Ambient Growth Plus Project Plus Cumulative (2025)
  - Existing 2022 counts
  - Ambient growth traffic (6.12%)
  - Cumulative Development traffic
  - Project traffic

EXHIBIT 4-4: CUMULATIVE DEVELOPMENT LOCATION MAP

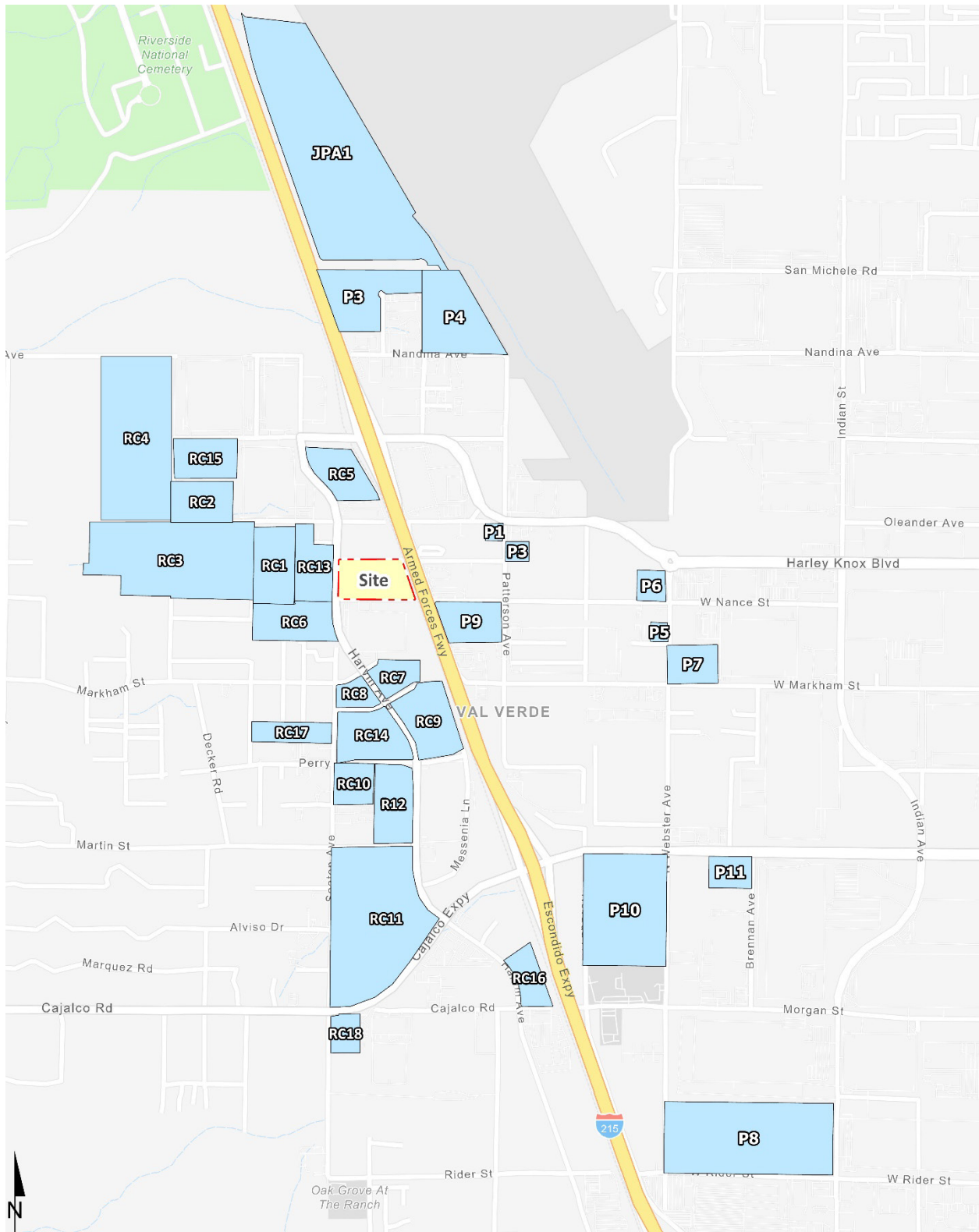

**EXHIBIT 4-5: CUMULATIVE ONLY TRAFFIC VOLUMES**

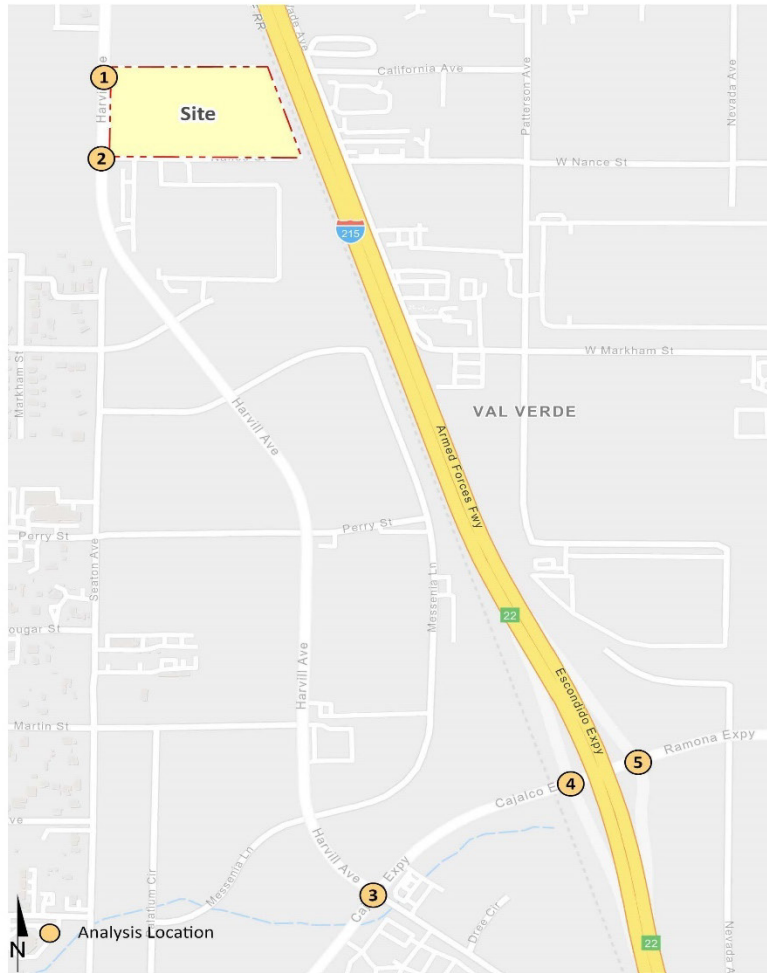

1	Harvill Av. & Driveway 1	2	Harvill Av. & America's Tire Dr.	3	Harvill Av. & Cajalco Exwy.
15,650		15,700	350	15,800	24,850
2(1) ↓ 410(826) 1(4) → 1(4) ↓ 5(2) → 772(529) →		41(16) ↓ 370(814) 13(41) → 6(21) ↓ 19(8) → 764(490) →		53(131) ↓ 100(88) ↓ 217(667) ↑ 621(270) ↑ 412(253) ↓ 461(205) ↑ 133(96) → 120(471) → 159(71) ↓ 53(166) → 69(116) ↑ 156(454) ↑	
150		15,700	1,850	15,550	9,900
4	I-215 SB Ramps & Ramona Exwy.	5	I-215 NB Ramps & Ramona Exwy.		
17,000	22,050	13,550	23,500		
610(268) ↓ 891(1144) ← 894(490) ↑ 235(420) 323(984) → 173(606) ↓		191(595) → 1022(1534) → 559(286) → 218(158) →	↑ 836(1065) ← 570(624)		
24,850	9,250	22,050	8,650		

##(##) AM(PM) Peak Hour Intersection Volumes  
 ## Average Daily Trips

**TABLE 4-7: CUMULATIVE DEVELOPMENT LAND USE SUMMARY**

No.	Project Name / Case Number	Land Use	Quantity	Units <sup>1</sup>
RC1	Majestic Freeway Business Center - Building 20	High-Cube Warehouse	426.821	TSF
RC2	Majestic Freeway Business Center - Building 21,22	Warehousing	241.059	TSF
RC3	Knox Logistics Center	High-Cube Warehouse	1,259.410	TSF
RC4	Oleander Business Park	High-Cube Warehouse	680.000	TSF
RC5	PPT190031	High-Cube Warehouse	418.000	TSF
RC6	Majestic Freeway Business Center - Building 19	Warehousing	364.560	TSF
RC7	Majestic Freeway Business Center - Building 12	Warehousing	154.751	TSF
RC8	Majestic Freeway Business Center - Building 15	Warehousing	90.279	TSF
RC9	Majestic Freeway Business Center - Building 11	High-Cube Warehouse	391.045	TSF
RC10	PPT180025: Seaton Commerce Center	High-Cube Warehouse	210.800	TSF
RC11	Majestic Freeway Business Center - Buildings 1, 3 & 4	Warehousing	48.930	TSF
		High-Cube Warehouse	1,195.740	TSF
RC12	Majestic Freeway Business Center - Building 13	High-Cube Warehouse	322.997	TSF
RC13	Majestic Freeway Business Center - Building 18	High-Cube Warehouse	368.648	TSF
RC14	Majestic Freeway Business Center - Building 14A/B	Warehousing	354.583	TSF
RC15	PPT210130	Warehousing	239.308	TSF
RC16	Harvill & Cajalco Warehouse	General Light Industrial	99.770	TSF
		Truck Trailer Yard	133	Spaces
RC17	PPT210022	General Light Industrial	98.940	TSF
RC18	PPT210133	Warehousing	350.481	TSF
P1	Canyon Steel (CS)	Industrial	25.000	TSF
P2	First March Logistics	Warehousing	589.971	TSF
P3	Duke - Patterson at Nance	High-Cube Warehouse	580.000	TSF
P4	Western Industrial (DRP19-00003)	High-Cube Warehouse	250.000	TSF
P5	Marijuana Manufacturing (MM)	Industrial	1.000	TSF
P6	AAA	Industrial	2.000	TSF
P7	Integra Expansion / MMOD 17-05075	High-Cube Warehouse	273.000	TSF
P8	Rados / DPR 07-0119	High-Cube Warehouse	1,200.000	TSF
P9	Patterson Commerce Center	High-Cube Fulfillment	224.247	TSF
		High-Cube Cold Storage	39.573	TSF
P10	Ramona Gateway Commerce Center	High-Cube Fulfillment	902.713	TSF
		High-Cube Cold Storage	47.511	TSF
		Fast-Food Restaurant w/	16.500	TSF
		Fast-Food Restaurant w/	10.200	TSF
		Coffee Shop w/ DT	2.400	TSF
		Automated Car Wash	1.000	Tunnel
		Gas Station w/ Market	16.000	VFP
P11	Ramona & Brennan	Warehousing	162.871	TSF
JPA1	VIP 215	High-Cube Warehouse	2,219.850	TSF

<sup>1</sup> TSF = Thousand Square Feet; VFP = Vehicle Fueling Positions

This page intentionally left blank

## 5 EAP (2025) TRAFFIC CONDITIONS

This section discusses the traffic forecasts for EAP (2025) conditions and the resulting intersection operations, traffic signal warrant, and queuing analyses.

### 5.1 ROADWAY IMPROVEMENTS

The lane configurations and traffic controls assumed to be in place for EAP (2025) conditions are consistent with those shown previously on Exhibit 3-1, with the exception of the following:

- Project driveways and those facilities assumed to be constructed by the Project to provide site access are also assumed to be in place for EAP conditions only (e.g., intersection and roadway improvements at the Project's frontage and driveways).
- The I-215 Freeway at Placentia Avenue interchange which is anticipated to be completed and open in Fall of 2022 has been assumed to be completed with improvements in place for EAP (2025) traffic conditions.

### 5.2 EAP (2025) TRAFFIC VOLUME FORECASTS

This scenario includes Existing (2022) traffic volumes plus an ambient growth factor of 6.12% and the addition of Project traffic. The weekday ADT volumes and peak hour volumes which can be expected for EAP (2025) traffic conditions are shown on Exhibit 5-1.

### 5.3 INTERSECTION OPERATIONS ANALYSIS

EAP (2025) peak hour traffic operations have been evaluated for the study area intersections based on the analysis methodologies presented in Section 2 Methodologies of this TA. The intersection analysis results are summarized on Table 5-1 for EAP traffic conditions, which indicate that all of the study area intersections are anticipated to continue to operate at an acceptable LOS under EAP traffic conditions. Intersection operations improve at the I-215 Freeway and Ramona Expressway interchange for EAP traffic conditions as there are reductions to the baseline traffic volumes with the opening of the I-215 Freeway and Placentia Avenue interchange. The intersection operations analysis worksheets for EAP traffic conditions are included in Appendix 5.1 of this TA.

EXHIBIT 5-1: EAP (2025) TRAFFIC VOLUMES

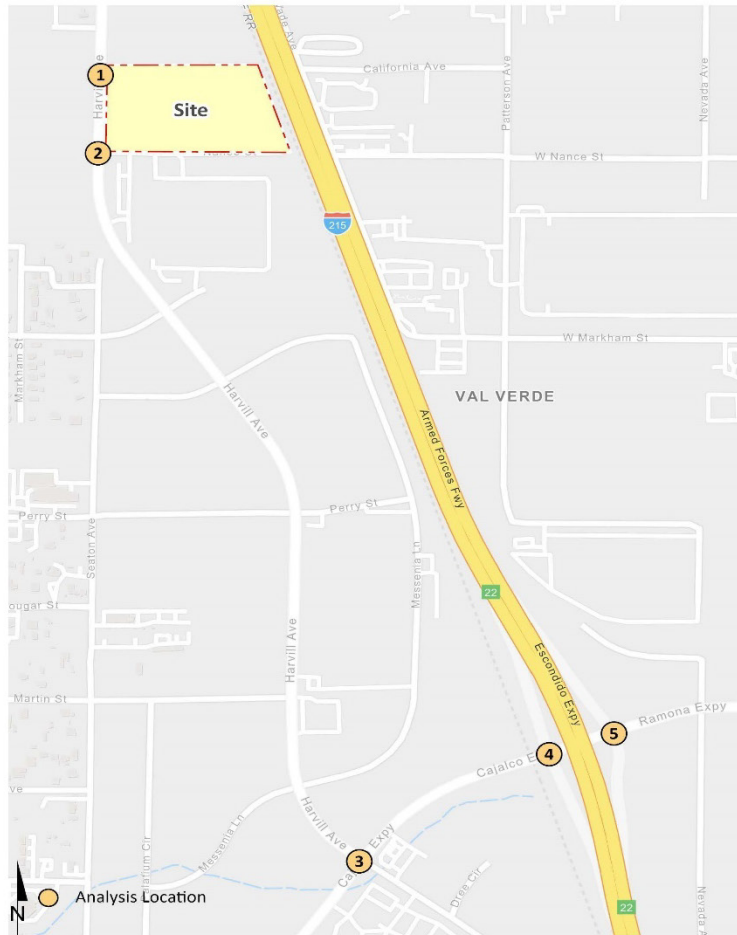

<p><b>1</b> Harvill Av. &amp; Driveway 1</p> <table border="1"> <tr> <td>9,150</td> <td>150</td> </tr> <tr> <td>                     ← 470(643)                      ↓ 4(2)                      ↑ 1(5)                      ↓ 0(2)                 </td> <td>                     ↑ 737(563)                      ↓ 1(1)                 </td> </tr> <tr> <td>9,100</td> <td>9,100</td> </tr> </table>	9,150	150	← 470(643) ↓ 4(2) ↑ 1(5) ↓ 0(2)	↑ 737(563) ↓ 1(1)	9,100	9,100	<p><b>2</b> Harvill Av. &amp; America's Tire Dr.</p> <table border="1"> <tr> <td>9,100</td> <td>350</td> </tr> <tr> <td>                     ← 253(344)                      ↓ 7(1)                      ↑ 2(9)                      ↓ 2(9)                 </td> <td>                     ↑ 436(354)                      ↓ 8(4)                 </td> </tr> <tr> <td>10,150</td> <td>10,150</td> </tr> </table>	9,100	350	← 253(344) ↓ 7(1) ↑ 2(9) ↓ 2(9)	↑ 436(354) ↓ 8(4)	10,150	10,150	<p><b>3</b> Harvill Av. &amp; Cajalco Exwy.</p> <table border="1"> <tr> <td>11,750</td> <td>28,800</td> </tr> <tr> <td>                     ↓ 20(36)                      ↓ 108(215)                      ↓ 186(238)                 </td> <td>                     ↑ 106(188)                      ↑ 666(634)                      ↓ 143(107)                 </td> </tr> <tr> <td>                     40(24) ↓                      664(728) →                      51(212) ↓                 </td> <td>                     ↑ 302(169)                      ↑ 350(150)                      ↑ 69(123)                 </td> </tr> <tr> <td>10,150</td> <td>13,950</td> </tr> <tr> <td>25,750</td> <td>25,750</td> </tr> </table>	11,750	28,800	↓ 20(36) ↓ 108(215) ↓ 186(238)	↑ 106(188) ↑ 666(634) ↓ 143(107)	40(24) ↓ 664(728) → 51(212) ↓	↑ 302(169) ↑ 350(150) ↑ 69(123)	10,150	13,950	25,750	25,750
9,150	150																							
← 470(643) ↓ 4(2) ↑ 1(5) ↓ 0(2)	↑ 737(563) ↓ 1(1)																							
9,100	9,100																							
9,100	350																							
← 253(344) ↓ 7(1) ↑ 2(9) ↓ 2(9)	↑ 436(354) ↓ 8(4)																							
10,150	10,150																							
11,750	28,800																							
↓ 20(36) ↓ 108(215) ↓ 186(238)	↑ 106(188) ↑ 666(634) ↓ 143(107)																							
40(24) ↓ 664(728) → 51(212) ↓	↑ 302(169) ↑ 350(150) ↑ 69(123)																							
10,150	13,950																							
25,750	25,750																							
<p><b>4</b> I-215 SB Ramps &amp; Ramona Exwy.</p> <table border="1"> <tr> <td>10,250</td> <td>28,200</td> </tr> <tr> <td>                     ↓ 115(107)                      ↓ 1(4)                      ↓ 584(715)                 </td> <td>                     ↑ 808(669)                      ↓ 241(303)                 </td> </tr> <tr> <td>                     445(575) →                      245(263) ↓                 </td> <td></td> </tr> <tr> <td>20,900</td> <td>7,700</td> </tr> <tr> <td>20,900</td> <td>32,400</td> </tr> </table>	10,250	28,200	↓ 115(107) ↓ 1(4) ↓ 584(715)	↑ 808(669) ↓ 241(303)	445(575) → 245(263) ↓		20,900	7,700	20,900	32,400	<p><b>5</b> I-215 NB Ramps &amp; Ramona Exwy.</p> <table border="1"> <tr> <td>7,800</td> <td>39,050</td> </tr> <tr> <td></td> <td>                     ↑ 477(464)                      ↓ 796(718)                 </td> </tr> <tr> <td>                     80(80) ↓                      952(1213) →                 </td> <td>                     ↑ 255(256)                      ↑ 3(3)                      ↑ 439(338)                 </td> </tr> <tr> <td>7,700</td> <td>8,550</td> </tr> <tr> <td>32,400</td> <td>32,400</td> </tr> </table>	7,800	39,050		↑ 477(464) ↓ 796(718)	80(80) ↓ 952(1213) →	↑ 255(256) ↑ 3(3) ↑ 439(338)	7,700	8,550	32,400	32,400			
10,250	28,200																							
↓ 115(107) ↓ 1(4) ↓ 584(715)	↑ 808(669) ↓ 241(303)																							
445(575) → 245(263) ↓																								
20,900	7,700																							
20,900	32,400																							
7,800	39,050																							
	↑ 477(464) ↓ 796(718)																							
80(80) ↓ 952(1213) →	↑ 255(256) ↑ 3(3) ↑ 439(338)																							
7,700	8,550																							
32,400	32,400																							

##(##) AM(PM) Peak Hour Intersection Volumes

## Average Daily Trips

**TABLE 5-1: INTERSECTION ANALYSIS FOR EAP (2025) CONDITIONS**

# Intersection	Traffic Control <sup>2</sup>	Existing (2022)				EAP (2025)			
		Delay <sup>1</sup> (secs.)		Level of Service		Delay <sup>1</sup> (secs.)		Level of Service	
		AM	PM	AM	PM	AM	PM	AM	PM
1 Harvill Av. & Driveway 1	<b>CSS</b>	Future Intersection				11.2	11.7	A	B
2 Harvill Av. & America's Tire Dr.	CSS	8.3	9.4	A	A	12.7	12.3	B	B
3 Harvill Av. & Cajalco Exwy.	TS	38.4	37.8	D	D	40.1	39.5	D	D
4 I-215 SB Ramps & Ramona Exwy.	TS	36.7	43.9	D	D	33.6	35.4	C	D
5 I-215 NB Ramps & Ramona Exwy.	TS	25.5	18.4	C	B	18.8	15.3	B	B

<sup>1</sup> Per the Highway Capacity Manual (6th Edition), overall average intersection delay and level of service are shown for intersections with a traffic signal or all way stop control. For intersections with cross street stop control, the delay and level of service for the worst individual movement (or movements sharing a single lane) are shown. HCM delay reported in seconds.

<sup>2</sup> TS = Traffic Signal; CSS = Cross-street Stop; **CSS** = Improvement

### 5.4 TRAFFIC SIGNAL WARRANTS ANALYSIS

The traffic signal warrant analysis for EAP (2025) traffic conditions are based on the peak hour volumes or planning level ADT volume-based traffic signal warrants. No study area intersections are anticipated to meet either peak hour volume or ADT volume-based warrants with the addition of Project traffic (see Appendix 5.2).

### 5.5 QUEUING ANALYSIS

Queuing analysis findings for EAP (2025) are presented on Table 5-2. As shown on Table 5-2, there are no movements that are anticipated to experience queuing issues during the weekday AM or weekday PM peak 95<sup>th</sup> percentile traffic flows with the addition of Project traffic. Worksheets for EAP (2025) traffic conditions queuing analysis are provided in Appendix 5.3.



**TABLE 5-2: PEAK HOUR QUEUING SUMMARY FOR EAP (2025) CONDITIONS**

Intersection	Movement	Available Stacking Distance (Feet)	Existing (2022)				EAP (2025)			
			95th Percentile Queue (Feet)		Acceptable? <sup>1</sup>		95th Percentile Queue (Feet)		Acceptable? <sup>1</sup>	
			AM Peak	PM Peak	AM	PM	AM Peak	PM Peak	AM	PM
I-215 SB Ramps & Ramona Exwy.	SBL	530	445 <sup>2</sup>	468 <sup>2</sup>	Yes	Yes	468 <sup>2</sup>	424 <sup>2</sup>	Yes	Yes
	SBT	1,100	448 <sup>2</sup>	481 <sup>2</sup>	Yes	Yes	469 <sup>2</sup>	437 <sup>2</sup>	Yes	Yes
	SBR	530	138	78	Yes	Yes	76	46	Yes	Yes
I-215 NB Ramps & Ramona Exwy.	NBL	520	184	176	Yes	Yes	152	147	Yes	Yes
	NBT	1,120	187	181	Yes	Yes	151	144	Yes	Yes
	NBR	520	685 <sup>2,3</sup>	457 <sup>2</sup>	Yes	Yes	478 <sup>2</sup>	302	Yes	Yes

<sup>1</sup> Stacking Distance is acceptable if the required stacking distance is less than or equal to the stacking distance provided. An additional 25 feet of stacking which is assumed to be provided in the transition for turn pockets is reflected in the stacking distance shown on this table, where applicable.

<sup>2</sup> 95th percentile volume exceeds capacity, queue may be longer. Queue shown is maximum after two cycles.

<sup>3</sup> Although 95th percentile queue is anticipated to exceed the available storage for the turn lane, the adjacent through lane has sufficient storage to accommodate any spillover without spilling back and affecting the I-215 Freeway mainline.

## 5.6 PROJECT DEFICIENCIES AND RECOMMENDED IMPROVEMENTS

The study area intersections are anticipated to operate at an acceptable LOS with the addition of Project traffic. As such, no additional improvements aside from those that are needed to facilitate site access have been recommended. As shown previously in Table 5-2, there are no movements that are anticipated to experience queuing issues during the weekday AM or weekday PM peak 95<sup>th</sup> percentile traffic flows for EAP (2025) traffic conditions. As such, no improvements have been identified for the off-ramps.

## 6 EAPC (2025) TRAFFIC CONDITIONS

This section discusses the traffic forecasts for EAPC (2025) conditions and the resulting intersection operations, traffic signal warrant, and queuing analyses.

### 6.1 ROADWAY IMPROVEMENTS

The lane configurations and traffic controls assumed to be in place for EAPC (2025) conditions are consistent with those shown previously on Exhibit 3-1, with the exception of the following:

- Project driveways and those facilities assumed to be constructed by the Project to provide site access are also assumed to be in place for EAPC (2025) conditions only (e.g., intersection and roadway improvements at the Project's frontage and driveways).
- Driveways and those facilities assumed to be constructed by cumulative developments to provide site access are also assumed to be in place for EAPC (2025) conditions only (e.g., intersection and roadway improvements along the cumulative development's frontages).
- The I-215 Freeway at Placentia Avenue interchange which is anticipated to be completed and open in Fall of 2022 has been assumed to be completed with improvements in place for EAPC (2025) traffic conditions.

### 6.2 EAPC (2025) TRAFFIC VOLUME FORECASTS

This scenario includes Existing (2022) traffic volumes plus an ambient growth factor of 6.12%, traffic from pending and approved cumulative development projects, and the addition of Project traffic. The weekday ADT volumes and peak hour volumes which can be expected for EAPC (2025) traffic conditions are shown on Exhibit 6-1.

### 6.3 INTERSECTION OPERATIONS ANALYSIS

LOS calculations were conducted for the study intersections to evaluate their operations under EAPC (2025) conditions with roadway and intersection geometrics consistent with Section 6.1 Roadway Improvements. As shown on Table 6-1, the study area intersections are anticipated to operate at an acceptable LOS under EAPC (2025) traffic conditions with the exception of the following intersections:

- Harvill Av. & Cajalco Exwy. (#3) – LOS F AM and PM peak hours
- I-215 SB Ramps & Ramona Exwy. (#4) – LOS F AM and PM peak hours
- I-215 NB Ramps & Ramona Exwy. (#5) – LOS F AM and PM peak hours

The intersection operations analysis worksheets for EAPC (2025) traffic conditions are included in Appendix 6.1 of this TA.

**EXHIBIT 6-1: EAPC (2025) TRAFFIC VOLUMES**

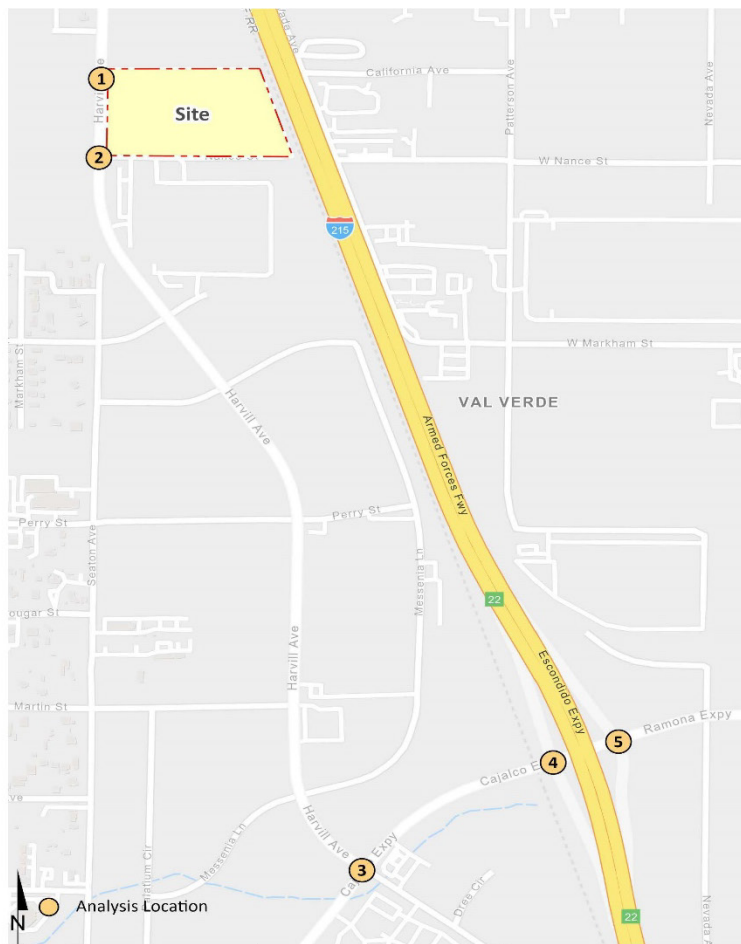

1 Harvill Av. & Driveway 1		2 Harvill Av. & America's Tire Dr.		3 Harvill Av. & Cajalco Exwy.	
24,850	150	24,800	700	27,550	53,700
↓ 2(1) ← 881(1469) ↘ 4(2)	↑ 1(5) ↗ 0(2)	↓ 41(16) ← 633(1158) ↘ 7(1)	↑ 2(9) ↗ 2(9)	↓ 73(167) ← 209(303) ↘ 403(905)	↑ 727(458) ↗ 1078(887) ↘ 604(313)
↑ 1(4) → 1(4)	↖ 5(2) ↑ 1510(1092) ↗ 1(1)	↑ 13(41) → 6(21)	↑ 19(8) → 1201(844) ↘ 8(4)	↑ 173(121) → 784(1199) ↓ 210(284)	↖ 355(335) ↑ 420(265) ↗ 225(577)
150	24,800	1,850	25,700	35,650	28,300
4 I-215 SB Ramps & Ramona Exwy.		5 I-215 NB Ramps & Ramona Exwy.			
27,200	50,250	21,350	62,550		
↓ 724(376) ← 1(4) ↘ 1508(1860)	← 1703(1155) ↗ 475(727)	↑ 1313(1529) ← 1365(1342)			
↑ 735(1558) → 418(869)		↑ 271(675) → 1975(2747)	↑ 814(542) ↘ 3(3) ↑ 657(496)		
45,750	17,000	54,450	17,200		

##(##) AM(PM) Peak Hour Intersection Volumes

## Average Daily Trips

**TABLE 6-1: INTERSECTION ANALYSIS FOR EAPC (2025) CONDITIONS**

# Intersection	Traffic Control <sup>2</sup>	EAPC (2025)			
		Delay <sup>1</sup> (secs.)		Level of Service	
		AM	PM	AM	PM
1 Harvill Av. & Driveway 1	<b>CSS</b>	16.9	17.4	C	C
2 Harvill Av. & America's Tire Dr.	CSS	26.8	22.2	D	C
3 Harvill Av. & Cajalco Exwy.	TS	<b>153.8</b>	<b>&gt;200.0</b>	<b>F</b>	<b>F</b>
4 I-215 SB Ramps & Ramona Exwy.	TS	<b>183.5</b>	<b>&gt;200.0</b>	<b>F</b>	<b>F</b>
5 I-215 NB Ramps & Ramona Exwy.	TS	<b>&gt;200.0</b>	<b>&gt;200.0</b>	<b>F</b>	<b>F</b>

\* **BOLD** = Level of Service (LOS) does not meet the applicable jurisdictional requirements (i.e., unacceptable L

<sup>1</sup> Per the Highway Capacity Manual (6th Edition), overall average intersection delay and level of service are shown for intersections with a traffic signal or all way stop control. For intersections with cross street stop control, the delay and level of service for the worst individual movement (or movements sharing a single lane) are shown. HCM delay reported in seconds.

<sup>2</sup> TS = Traffic Signal; CSS = Cross-street Stop; **CSS** = Improvement

### 6.4 TRAFFIC SIGNAL WARRANTS ANALYSIS

The traffic signal warrant analysis for EAPC (2025) traffic conditions are based on the peak hour volumes or planning level ADT volume-based traffic signal warrants. There are no study area intersections anticipated to meet peak hour or planning level (ADT) warrant for EAPC (2025) traffic conditions (see Appendix 6.2).

### 6.5 QUEUING ANALYSIS

Queuing analysis findings for EAPC (2025) are presented on Table 6-2. As shown on Table 6-2, there are no movements that are anticipated to experience queuing issues during the weekday AM or weekday PM peak 95<sup>th</sup> percentile traffic flows with the addition of Project traffic, with the exception of the following movements:

- I-215 SB Ramps & Ramona Exwy. (#4): Southbound Left (AM and PM peak hours, Southbound Left-Through (AM and PM peak hours), and Southbound Right (AM peak hour only)
- I-215 NB Ramps & Ramona Exwy. (#5): Northbound Right (AM peak hour only)

Worksheets for EAPC (2025) traffic conditions queuing analysis are provided in Appendix 6.3.

**TABLE 6-2: PEAK HOUR QUEUING SUMMARY FOR EAPC (2025) CONDITIONS**

Intersection	Movement	Available Stacking Distance	95th Percentile Queue (Feet)		Acceptable? <sup>1</sup>	
			AM Peak	PM Peak	AM	PM
I-215 SB Ramps & Ramona Exwy.	SBL	530	1,302 <sup>2</sup>	1,412 <sup>2</sup>	<b>No</b>	<b>No</b>
	SBT	1,100	1,304 <sup>2</sup>	1,426 <sup>2</sup>	<b>No</b>	<b>No</b>
	SBR	530	934 <sup>2</sup>	335	<b>No</b>	Yes
I-215 NB Ramps & Ramona Exwy.	NBL	520	418	271	Yes	Yes
	NBT	1,120	425 <sup>2</sup>	275	Yes	Yes
	NBR	520	993 <sup>2,3</sup>	616 <sup>2,3</sup>	<b>No</b>	Yes

<sup>1</sup> Stacking Distance is acceptable if the required stacking distance is less than or equal to the stacking distance provided. An additional 25 feet of stacking which is assumed to be provided in the transition for turn pockets is reflected in the stacking distance shown on this table, where applicable.

<sup>2</sup> 95th percentile volume exceeds capacity, queue may be longer. Queue shown is maximum after two cycles.

<sup>3</sup> Although 95th percentile queue is anticipated to exceed the available storage for the turn lane, the adjacent through lane has sufficient storage to accommodate any spillover without spilling back and affecting the I-215 Freeway mainline.

## 6.6 NEAR-TERM DEFICIENCIES AND RECOMMENDED IMPROVEMENTS

This section provides a summary of Project deficiencies and recommended improvements. Based on the County of Riverside deficiency criteria discussed in Section 2.6 Deficiency Criteria, roadway intersections were found to be deficient. Improvements necessary to improve project-related traffic deficiencies are shown in Table 6-3. Table 6-3 indicates the physical improvements needed to address LOS deficiencies at each of the study area intersections under EAPC (2025) traffic conditions. The improvements have been identified to improve the EAPC (2025) deficiencies back to acceptable levels. Intersection analysis worksheets for EAPC (2025) traffic conditions, with improvements, are provided in Appendix 6.4.

**TABLE 6-3: INTERSECTION ANALYSIS FOR EAPC (2025) CONDITIONS WITH IMPROVEMENTS**

# Intersection	Traffic Control <sup>3</sup>	Intersection Approach Lanes <sup>1</sup>												Delay <sup>2</sup> (secs.)		Level of Service		
		Northbound			Southbound			Eastbound			Westbound			AM	PM	AM	PM	
		L	T	R	L	T	R	L	T	R	L	T	R					
3 Harvill Av. & Cajalco Exwy.																		
- Without Improvement:	TS	2	2	0	2	2	0	1	2	1	2	2	1>	<b>153.8</b>	<b>&gt;200.0</b>	<b>F</b>	<b>F</b>	
- With Improvements	TS	2	2	0	2	2	0	1	<b>3</b>	1	2	<b>3</b>	1	53.4	54.1	D	D	
4 I-215 SB Ramps & Ramona Exwy.																		
- Without Improvement:	TS	0	0	0	1	1	1	0	2	0	1	2	0	<b>183.5</b>	<b>&gt;200.0</b>	<b>F</b>	<b>F</b>	
- With Improvements	TS	0	0	0	<b>2</b>	1	1	0	<b>3</b>	<b>1</b>	<b>2</b>	<b>3</b>	0	35.8	54.6	D	D	
5 I-215 NB Ramps & Ramona Exwy.																		
- Without Improvement:	TS	1	1	1	0	0	0	1	2	0	0	2	1	<b>&gt;200.0</b>	<b>&gt;200.0</b>	<b>F</b>	<b>F</b>	
- With Improvements	TS	1	1	1	0	0	0	<b>2</b>	<b>3</b>	0	0	<b>3</b>	<b>1&gt;&gt;</b>	36.4	33.3	D	C	

**LOS** = LOS does not meet the applicable jurisdictional requirements (i.e., unacceptable LOS).

<sup>1</sup> When a right turn is designated, the lane can either be striped or unstriped. To function as a right turn lane there must be sufficient width for right turning vehicles to travel outside the through lanes.

L = Left; T = Through; R = Right; > = Right-Turn Overlap Phasing; >> = Free Right Turn Lane; **1** = Improvement

<sup>2</sup> Per the Highway Capacity Manual 6th Edition, overall average intersection delay and level of service are shown for intersections with a traffic signal or all-way stop control. For intersections with cross street stop control, the delay and level of service for the worst individual movement (or movements sharing a single lane) are shown.

<sup>3</sup> TS = Traffic Signal

With the proposed intersection improvements at the I-215 Southbound Ramps and Ramona Expressway, the peak hour queues are also anticipated to improve (see Table 6-4). The I-215 Southbound Ramps also require southbound left turn storage of 700-feet to accommodate the anticipated future peak hour queues.

**TABLE 6-4: PEAK HOUR QUEUING SUMMARY FOR EAPC (2025) CONDITIONS WITH IMPROVEMENTS**

Intersection	Movement	Available Stacking Distance	95th Percentile Queue (Feet)		Acceptable? <sup>1</sup>	
			AM Peak	PM Peak	AM	PM
I-215 SB Ramps & Ramona Exwy.	SBL	<b>700</b>	429	696 <sup>2,3</sup>	Yes	Yes
	SBT	1,100	482	789 <sup>2</sup>	Yes	Yes
	SBR	530	804 <sup>2,3</sup>	350	Yes	Yes
I-215 NB Ramps & Ramona Exwy.	NBL	520	390	313	Yes	Yes
	NBT	1,120	393 <sup>2</sup>	317	Yes	Yes
	NBR	520	930 <sup>2,3</sup>	696 <sup>2,3</sup>	Yes	Yes

<sup>1</sup> Stacking Distance is acceptable if the required stacking distance is less than or equal to the stacking distance provided. An additional 25 feet of stacking which is assumed to be provided in the transition for turn pockets is reflected in the stacking distance shown on this table, where applicable.

<sup>2</sup> 95th percentile volume exceeds capacity, queue may be longer. Queue shown is maximum after two cycles.

<sup>3</sup> Although 95th percentile queue is anticipated to exceed the available storage for the turn lane, the adjacent through lane has sufficient storage to accommodate any spillover without spilling back and affecting the I-215 Freeway mainline.

This page intentionally left blank

## 7 LOCAL AND REGIONAL FUNDING MECHANISMS

Transportation improvements within the County of Riverside are funded through a combination of improvements constructed by the Project, development impact fee programs. Fee programs applicable to the Project are described below.

### 7.1 RIVERSIDE COUNTY TRANSPORTATION UNIFORM MITIGATION FEE (TUMF)

The TUMF program is administered by the WRCOG based upon a regional Nexus Study most recently updated in 2016 to address major changes in right of way acquisition and improvement cost factors. (7) This regional program was put into place to ensure that development pays its fair share, and that funding is in place for construction of facilities needed to maintain the requisite level of service and critical to mobility in the region. TUMF is a truly regional mitigation fee program and is imposed and implemented in every jurisdiction in Western Riverside County.

### 7.2 RIVERSIDE COUNTY DEVELOPMENT IMPACT FEE (DIF) PROGRAM

The Project is located within the County's Mead Valley Area Plan and therefore will be subject to County of Riverside DIF in an effort by the County to address development throughout its unincorporated area. The DIF program consists of two separate transportation components: the Roads, Bridges and Major Improvements component and the Traffic Signals component. Eligible facilities for funding by the County DIF program are identified on the County's Public Needs List, which currently extends through the year 2020. (8) A comprehensive review of the DIF program is now planned in order to update the nexus study. This will result in development of a revised "needs list" extending the program time horizon from 2010 to 2030.

The cost of signaling DIF network intersections is identified under the Traffic Signals component of the DIF program. County staff generally defines DIF eligible intersections as those consisting of two intersecting general plan roadways. If the intersection meets this requirement, it is potentially eligible for up to \$235,000 of credit, which is subject to negotiations with the County.

### 7.3 MEASURE A

Measure A, Riverside County's half-cent sales tax for transportation, was adopted by voters in 1988 and extended in 2002. It will continue to fund transportation improvements through 2038. Measure A funds a wide variety of transportation projects and services throughout the County. Riverside County Transportation Commission (RCTC) is responsible for administering the program. Measure A dollars are spent in accordance with a voter-approved expenditure plan that was adopted as part of the 1988 election.



## 7.4 FAIR SHARE CONTRIBUTION

Project improvements may include a combination of fee payments to established programs, construction of specific improvements, payment of a fair share contribution toward future improvements or a combination of these approaches. Improvements constructed by development may be eligible for a fee credit or reimbursement through the program where appropriate. When off-site improvements are identified with a minor share of responsibility assigned to proposed development, the approving jurisdiction may elect to collect a fair share contribution or require the development to construct improvements. Detailed fair share calculations, for each peak hour, have been provided in Table 7-1 for the applicable deficient study area intersections. These fees are collected with the proceeds solely used as part of a funding mechanism aimed at ensuring that regional highways and arterial expansions keep pace with the projected population increases.

**TABLE 7-1: PROJECT FAIR SHARE CALCULATIONS**

#	Intersection	Project			Net New Traffic	Project % of New Traffic	
		Existing	Only	EAPC			
3	Harvill Av. & Cajalco Exwy.	AM:	2,761	12	5,569	2,808	0.4%
		PM:	2,811	17	5,976	3,165	<b>0.5%</b>
4	I-215 SB Ramps & Ramona Exwy.	AM:	3,599	9	6,308	2,709	<b>0.3%</b>
		PM:	3,586	10	7,032	3,446	0.3%
5	I-215 NB Ramps & Ramona Exwy.	AM:	4,379	7	7,345	2,966	<b>0.2%</b>
		PM:	4,164	4	8,001	3,837	0.1%

**BOLD** = Denotes highest fair share percentage.

<sup>1</sup> Although the intersection operates at an acceptable LOS under EAPC traffic conditions, fair share calculations have been provided as the intersection meets peak hour warrants for a traffic signal under EAPC traffic conditions.

## 8 REFERENCES

1. **County of Riverside Transportation Department.** Transportation Analysis Guidelines for Level of Service and Vehicle Miles Traveled. County of Riverside : s.n., December 2020.
2. **Institute of Transportation Engineers.** Trip Generation Manual. 11th Edition. 2021.
3. **VRPA Technologies, Inc. for Riverside County Transportation Commission.** Riverside County Long Range Transportation Study. County of Riverside : VRPA Technologies, Inc., December 2019.
4. **Transportation Research Board.** Highway Capacity Manual (HCM). 6th Edition. s.l. : National Academy of Sciences, 2016.
5. **California Department of Transportation.** California Manual on Uniform Traffic Control Devices (CA MUTCD). [book auth.] California Department of Transportation. California Manual on Uniform Traffic Control Devices (CA MUTCD). 2014, Updated March 30, 2021 (Revision 6).
6. **Southern California Association of Governments (SCAG).** 2020 Regional Transportation Plan / Sustainable Communities Strategy. Adopted September 2020.
7. **Western Riverside Council of Governments.** TUMF Nexus Study, 2016 Program Update. July 2017.
8. **Willdan Financial Services.** County of Riverside Development Impact Fee Study Update. County of Riverside : s.n., 2013.

This page intentionally left blank

## **APPENDIX 1.1: APPROVED TRAFFIC STUDY SCOPING AGREEMENT**

This Page Intentionally Left Blank

**EXHIBIT B**

**SCOPING AGREEMENT FOR TRAFFIC IMPACT STUDY**

This letter acknowledges the Riverside County Transportation Department requirements for traffic impact analysis of the following project. The analysis must follow the Riverside County Transportation Department Traffic Study Guidelines dated April 2008.

Case No. PPT220015

Related Cases-

    SP No. 341

    EIR No. 466

    GPA No. \_\_\_\_\_

    CZ No. \_\_\_\_\_

Project Name: Majestic Freeway Business Center Specific Plan - Building 14A/14B

Project Address: Southwest corner of Harvill Av. & Commerce Center Dr.

Project Description: Building 14A = 210,655 square feet of warehousing use, Building 14B = 143,928 square feet of warehousing use (total of 354,583 square feet)

	<u>Consultant</u>		<u>Developer - Representative</u>
Name:	<u>Urban Crossroads Inc. - Charlene So</u>		<u>T&amp;B Planning</u>
Address:	<u>1133 Camelback St. #8329</u>		<u>3200 El Caminio Real, Suite 100</u>
	<u>Newport Beach, CA 92658</u>		<u>Irvine, CA 92602</u>
Telephone:	<u>949-861-0177</u>		_____
Fax:	_____		_____

**A. Trip Generation Source:** ITE Trip Generation Manual, 11th Edition (2021)

Current GP Land Use	<u>SP</u>	Proposed Land Use	<u>SP</u>
Current Zoning	<u>SP</u>	Proposed Zoning	<u>SP</u>

	Current Trip Generation			Proposed Trip Generation			
	<u>In</u>	<u>Out</u>	<u>Total</u>	<u>In</u>	<u>Out</u>	<u>Total</u>	
AM Trips	_____	_____	_____	<u>52</u>	<u>20</u>	<u>72</u>	(PCE)
PM Trips	_____	_____	_____	<u>27</u>	<u>53</u>	<u>80</u>	(PCE)

Internal Trip Allowance	<input type="checkbox"/> Yes	<input checked="" type="checkbox"/> No	( <u>0</u> % Trip Discount)
Pass-By Trip Allowance	<input type="checkbox"/> Yes	<input checked="" type="checkbox"/> No	( <u>0</u> % Trip Discount)

A passby trip discount of 25% is allowed for appropriate land uses. The passby trips at adjacent study area intersections and project driveways shall be indicated on a report figure.

**B. Trip Geographic Distribution:** (see distribution exhibits - varies)

N varies %      S varies %      E varies %      W varies %

**C. Background Traffic**

Project Build-out Year: 2025      Annual Ambient Growth Rate: 2 %

Phase Year(s) N/A

Other area Projects to be analyzed: County to provide updated list

Model/Forecast Methodology: Not Applicable



**D. Study Intersections:** (NOTE: Subject to revision after other projects, trip generation and distribution are determined, or comments form other agencies). (See Exhibit 1)

- |                                      |           |
|--------------------------------------|-----------|
| 1. Driveway 1 & Commerce Center Dr.  | 13. _____ |
| 2. Dirveway 2 & Commerce Center Dr.  | 14. _____ |
| 3. Driveway 3 & Perry St.            | 15. _____ |
| 4. Driveway 4 & Perry St.            | 16. _____ |
| 5. Harvill Av. & Commerce Center Dr. | 17. _____ |
| 6. Harvill Av. & Driveway 5          | 18. _____ |
| 7. Harvill Av. & Perry St.           | 19. _____ |
| 8. Harvill Av. & Cajalco Exwy.       | 20. _____ |
| 9. I-215 SB Ramps & Ramona Exwy.     | 21. _____ |
| 10. I-215 NB Ramps & Ramona Exwy.    | 22. _____ |
| 11. _____                            | 23. _____ |
| 12. _____                            | 24. _____ |

**E. Study Roadway Segments:** (NOTE: Subject to revision after other projects, trip generation and distribution are determined, or comments form other agencies).

1. \_\_\_\_\_ 2. \_\_\_\_\_

**F. Other Jurisdictional Impacts**

Is this project within a City's Sphere of influence or one mile radius of City boundaries?  Yes  No

If so, name of City jurisdiction: City of Perris, Caltrans (I-215 Freeway)

**G. Site Plan** (please attach reduced copy)

**H. Specific issues to be addressed in the Study (in addition to the standard analysis described in the Guideline)** (To be filled out by Transportation Department)

(NOTE: If the traffic study states that "a traffic signal is warranted" (or "a traffic signal appears to be warranted", or similar statement) at an existing unsignalized intersection under existing conditions, 8-hour approach traffic volume information must be submitted in addition to the peak hourly turning movement counts for that intersection.

Fair share percentages and rough order of magnitude fair share costs will be calculated for intersections not analyzed in this traffic study, but identified in the project conditions of approval.

**I. Existing Conditions**

Traffic count data must be new or recent. Provide traffic count dates if using other than new counts.

Date of counts: Traffic counts conducted in February 2022

**\*NOTE\* Traffic Study Submittal Form and appropriate fee must be submitted with, or prior to submittal of this form. Transportation Department staff will not process the Scoping Agreement prior to receipt of the fee.**

Recommended by:

Charlene S 3/4/2022  
 Consultant's Representative Date

Approved Scoping Agreement:

Eva Comarubias 08/10/2022  
 Riverside County Transportation Department Date

Scoping Agreement Revised on 8/8/2022



August 9, 2022

Mr. Kevin Tsang  
County of Riverside, Transportation Department  
4080 Lemon Street, 8th Floor  
Riverside, CA 92501

**SUBJECT: BUILDING 14A AND 14B OF THE MAJESTIC FREEWAY BUSINESS CENTER SPECIFIC PLAN  
TRAFFIC IMPACT ANALYSIS SCOPING AGREEMENT (REVISED)**

Dear Mr. Kevin Tsang:

The firm of Urban Crossroads, Inc. is pleased to submit this scoping letter regarding the traffic impact analysis for Building 14A and 14B of the Majestic Freeway Business Center Specific Plan (**Project**), which is located on the southwest corner of Harvill Avenue and Commerce Center Drive in the County of Riverside. This letter describes the proposed Project trip generation, trip distribution, and analysis methodology, which have been used to establish the draft proposed Project study area and analysis locations.

## **PROJECT DESCRIPTION**

A preliminary site use plan for the proposed Project is shown on Exhibit 1. Exhibit 2 depicts the location of the proposed project in relation to the existing roadway network. The Project is anticipated to have an Opening Year of 2025. Access to the Project site will be provided via Commerce Center Drive, Perry Street, and Harvill Avenue. The proposed Project consists of two buildings totaling 354,583 square feet of warehousing use (210,655 square feet for Building 14A and 143,928 square feet for Building 14B).



**EXHIBIT 1: PRELIMINARY SITE PLAN**

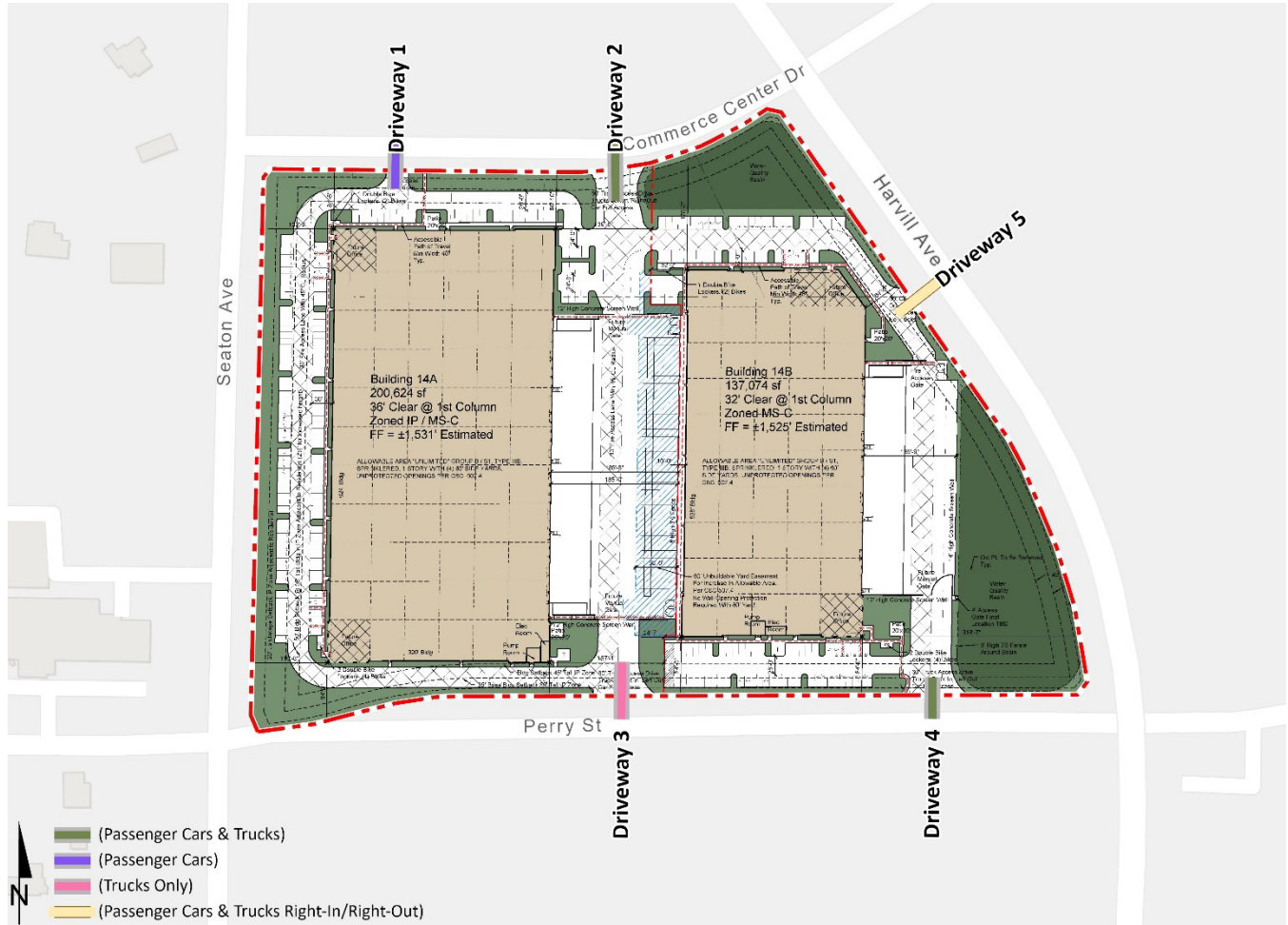

**EXHIBIT 2: STUDY AREA**



## TRIP GENERATION

Trip generation represents the amount of traffic that is attracted and produced by a development and is based upon the specific land uses planned for a given project. In order to develop the traffic characteristics of the proposed project, trip-generation statistics published in the Institute of Transportation Engineers (ITE) Trip Generation Manual (11<sup>th</sup> Edition, 2021) for the proposed land use was used. Trip generation rates for the Project are shown in Table 1 for both passenger car equivalent (PCE) and actual vehicles. The trip generation summary illustrating daily and peak hour trip generation estimates for the proposed Project in actual vehicles and PCE are shown in Table 2. The following ITE land use code and vehicle mix has been utilized:

- ITE land use code 150 (Warehousing) has been used to derive site specific trip generation estimates for the Project (both Buildings 14A and 14B). A warehouse is primarily devoted to the storage of materials but may also include office and maintenance areas. The vehicle mix has been obtained from the latest Trip Generation Manual. The truck percentages were further broken down by axle type per the following SCAQMD recommended truck mix: 2-Axle = 16.7%; 3-Axle = 20.7%; 4+-Axle = 62.6%.

**TABLE 1: TRIP GENERATION RATES**

Land Use <sup>1</sup>	Units <sup>2</sup>	ITE LU Code	AM Peak Hour			PM Peak Hour			Daily
			In	Out	Total	In	Out	Total	
<b>Actual Vehicle Trip Generation Rates</b>									
Warehousing <sup>3</sup>	TSF	150	0.131	0.039	0.170	0.050	0.130	0.180	1.710
Passenger Cars			0.116	0.034	0.150	0.042	0.108	0.150	1.110
2-Axle Trucks			0.002	0.001	0.003	0.003	0.002	0.005	0.100
3-Axle Trucks			0.002	0.002	0.004	0.003	0.003	0.006	0.124
4+-Axle Trucks			0.007	0.006	0.013	0.010	0.009	0.019	0.376
<b>Passenger Car Equivalent (PCE) Trip Generation Rates<sup>4</sup></b>									
Warehousing <sup>3</sup>	TSF	150	0.131	0.039	0.170	0.050	0.130	0.180	1.710
Passenger Cars			0.116	0.034	0.150	0.042	0.108	0.150	1.110
2-Axle Trucks (PCE = 1.5)			0.003	0.002	0.005	0.005	0.003	0.008	0.150
3-Axle Trucks (PCE = 2.0)			0.004	0.004	0.008	0.006	0.006	0.012	0.248
4+-Axle Trucks (PCE = 3.0)			0.021	0.017	0.038	0.030	0.026	0.056	1.127

<sup>1</sup> Trip Generation & Vehicle Mix Source: Institute of Transportation Engineers (ITE), Trip Generation Manual, Eleventh Edition (2021).

<sup>2</sup> TSF = thousand square feet

<sup>3</sup> Truck Mix: South Coast Air Quality Management District's (SCAQMD) recommended truck mix, by axle type.  
 Normalized % - Without Cold Storage: 16.7% 2-Axle trucks, 20.7% 3-Axle trucks, 62.6% 4-Axle trucks.

<sup>4</sup> PCE factors: 2-axle = 1.5; 3-axle = 2.0; 4+-axle = 3.0.

Finally, PCE factors were applied to the trip generation rates for heavy trucks (large 2-axes, 3-axes, 4+-axes). PCEs allow the typical “real-world” mix of vehicle types to be represented as a single, standardized unit, such as the passenger car, to be used for the purposes of capacity and level of service analyses. The PCE factors are consistent with the recommended PCE factors in the latest County Guidelines.

As shown on Table 2, the proposed Project is anticipated to generate a net total of 608 two-way trips per day with 61 AM peak hour trips and 64 PM peak hour trips (actual vehicles). The operations analyses for the Traffic Study will utilize the PCE trip generation consistent with the County Guidelines and other traffic studies prepared in the County of Riverside.

**TABLE 2: PROJECT TRIP GENERATION**

Land Use	Quantity Units <sup>1</sup>	AM Peak Hour			PM Peak Hour			Daily
		In	Out	Total	In	Out	Total	
<b>Actual Vehicles:</b>								
Warehousing (Buildings 14A + 14B)	354.583 TSF							
Passenger Cars:		43	11	54	12	41	53	394
2-axle Trucks:		1	0	1	1	1	2	36
3-axle Trucks:		1	1	2	1	1	2	44
4+-axle Trucks:		2	2	4	4	3	7	134
Total Truck Trips (Actual Vehicles):		4	3	7	6	5	11	214
<b>Total Trips (Actual Vehicles)<sup>2</sup></b>		<b>47</b>	<b>14</b>	<b>61</b>	<b>18</b>	<b>46</b>	<b>64</b>	<b>608</b>
<b>Passenger Car Equivalent (PCE):</b>								
Warehousing (Buildings 14A + 14B)	354.583 TSF							
Passenger Cars:		43	11	54	12	41	53	394
2-axle Trucks:		1	1	2	2	1	3	54
3-axle Trucks:		1	2	3	2	2	4	88
4+-axle Trucks:		7	6	13	11	9	20	400
Total Truck Trips (PCE):		9	9	18	15	12	27	542
<b>Total Trips (PCE)<sup>2</sup></b>		<b>52</b>	<b>20</b>	<b>72</b>	<b>27</b>	<b>53</b>	<b>80</b>	<b>936</b>

<sup>1</sup> TSF = thousand square feet

<sup>2</sup> Total Trips = Passenger Cars + Truck Trips.

## TRIP DISTRIBUTION

The Project trip distribution represents the directional orientation of traffic to and from the Project site. Trip distribution is the process of identifying the probable destinations, directions or traffic routes that will be utilized by Project traffic. The potential interaction between the planned land uses and surrounding regional access routes are considered, to identify the route where the Project traffic would distribute. Exhibit 3 illustrates the truck trip distribution patterns for the Project and Exhibit 4 illustrates the passenger car trip distribution patterns. Project passenger car and truck trip distribution patterns have been developed to be consistent with existing driveway and intersection counts conducted for locations along the Harvill Avenue corridor.

### EXHIBIT 3: PROJECT (TRUCK) TRIP DISTRIBUTION



**EXHIBIT 4: PROJECT (PASSENGER CAR) TRIP DISTRIBUTION**

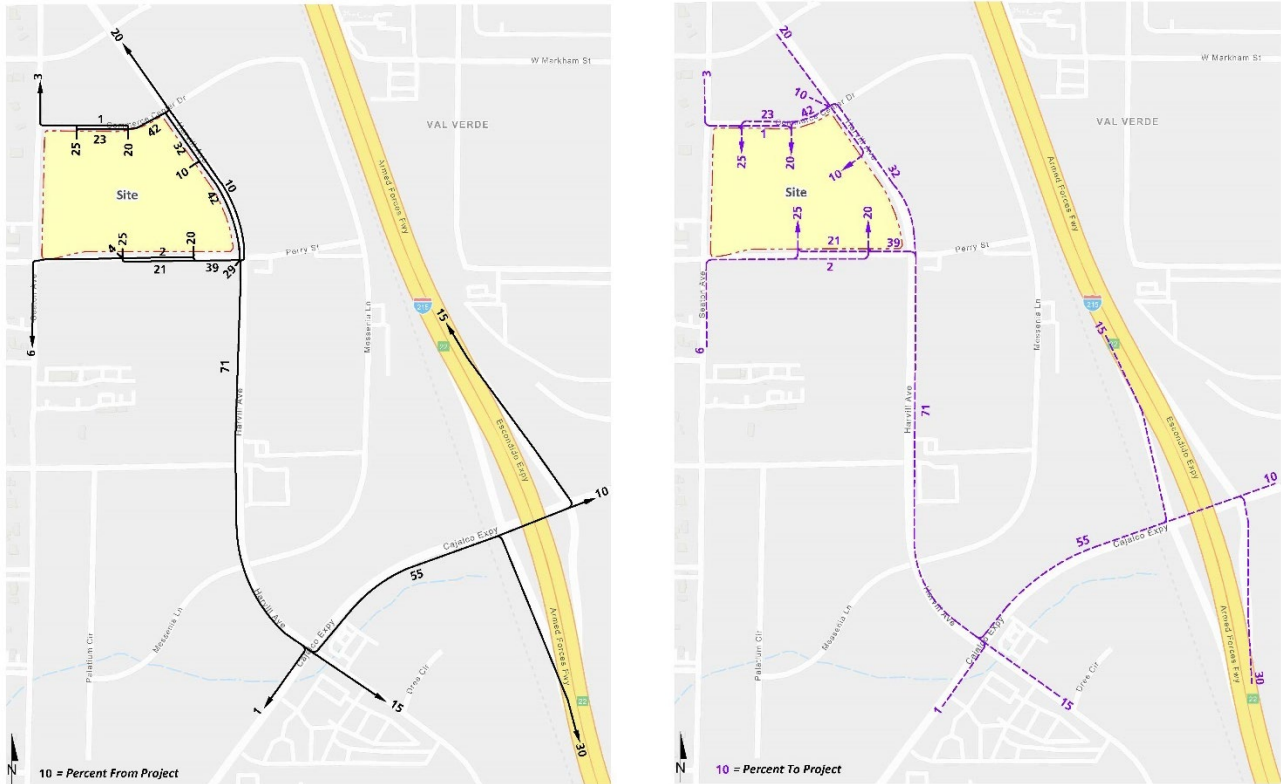

**ANALYSIS SCENARIOS**

Consistent with the County Guidelines, intersection analysis will be provided for the following analysis scenarios:

- Existing (2022) Conditions
- Existing plus Ambient Growth plus Project (EAP) Conditions
- Existing plus Ambient Growth plus Project plus Cumulative (EAPC) Conditions

All study area intersections will be evaluated using the Highway Capacity Manual (HCM) 6<sup>th</sup> Edition analysis methodology.

**CUMULATIVE PROJECTS**

A preliminary list of cumulative projects is provided in Table 3 and are shown on Exhibit 5. These cumulative projects are based on information collected from the County of Riverside.

**TABLE 3: CUMULATIVE DEVELOPMENT LAND USE SUMMARY**

No.	Project Name / Case Number	Land Use	Quantity Units <sup>1</sup>	Location
<b>Riverside County:</b>				
RC1	Majestic Freeway Business Center - Building 20	High-Cube Warehouse	426.821 TSF	S OF OLEANDER AV. AND W OF HARVILL AV.
RC2	Majestic Freeway Business Center - Building 21,22	Warehousing	241.059 TSF	NEC OF DECKER RD. & OLD OLEANDER AVE.
RC3	Knox Logistics Center	High-Cube Warehouse	1,259.410 TSF	NWC OF DECKER RD. & OLD OLEANDER AVE.
RC4	Oleander Business Park	High-Cube Warehouse	680.000 TSF	NWC OF DECKER RD. & HARLEY KNOX BLVD.
RC5	PPT190031	High-Cube Warehouse	418.000 TSF	SEC OF HARVILL AV. & HARLEY KNOX BL.
RC6	Majestic Freeway Business Center - Building 19	Warehousing	364.560 TSF	SWC OF HARVILL AVE. & OLD OLEANDER AVE.
RC7	Majestic Freeway Business Center - Building 12	Warehousing	154.751 TSF	NEC OF HARVILL AVE. & COMMERCE CENTER DR.
RC8	Majestic Freeway Business Center - Building 15	Warehousing	90.279 TSF	NWC OF HARVILL AVE. & COMMERCE CENTER DR.
RC9	Majestic Freeway Business Center - Building 11	High-Cube Warehouse	391.045 TSF	NEC OF HARVILL AVE. & PERRY ST.
RC10	PPT180025: Seaton Commerce Center	High-Cube Warehouse	210.800 TSF	SEC OF SEATON AV. & PERRY ST.
RC11	Majestic Freeway Business Center - Buildings 1, 3 & 4	Warehousing	48.930 TSF	NWC OF HARVILL AVE. & CAJALCO RD.
		High-Cube Warehouse	1,195.740 TSF	
RC12	Majestic Freeway Business Center - Building 18	High-Cube Warehouse	333.648 TSF	SWC OF HARVILL AVE. & PEREGRINE WY.
RC13	Majestic Freeway Business Center - Building 17	High-Cube Warehouse	268.955 TSF	NEC OF HARVILL AVE. & AMERICA'S TIRE DR.
RC14	Majestic Freeway Business Center - Building 13	High-Cube Warehouse	322.997 TSF	SWC OF HARVILL AVE. & PERRY ST.
RC15	PPT210130	Warehousing	239.308 TSF	SEC OF DECKER RD. & HARLEY KNOX BL.
RC16	Harvill & Cajalco Warehouse	General Light Industrial	99.770 TSF	NEC OF HARVILL AV. & CAJALCO RD.
		Truck Trailer Yard	133 Spaces	

<sup>1</sup> TSF = Thousand Square Feet

**TRAFFIC COUNTS**

Traffic counts (classified by vehicle type) were conducted in February 2022 when local schools were in session and operating on a typical bell schedule.



**EXHIBIT 5: CUMULATIVE DEVELOPMENT LOCATION MAP**

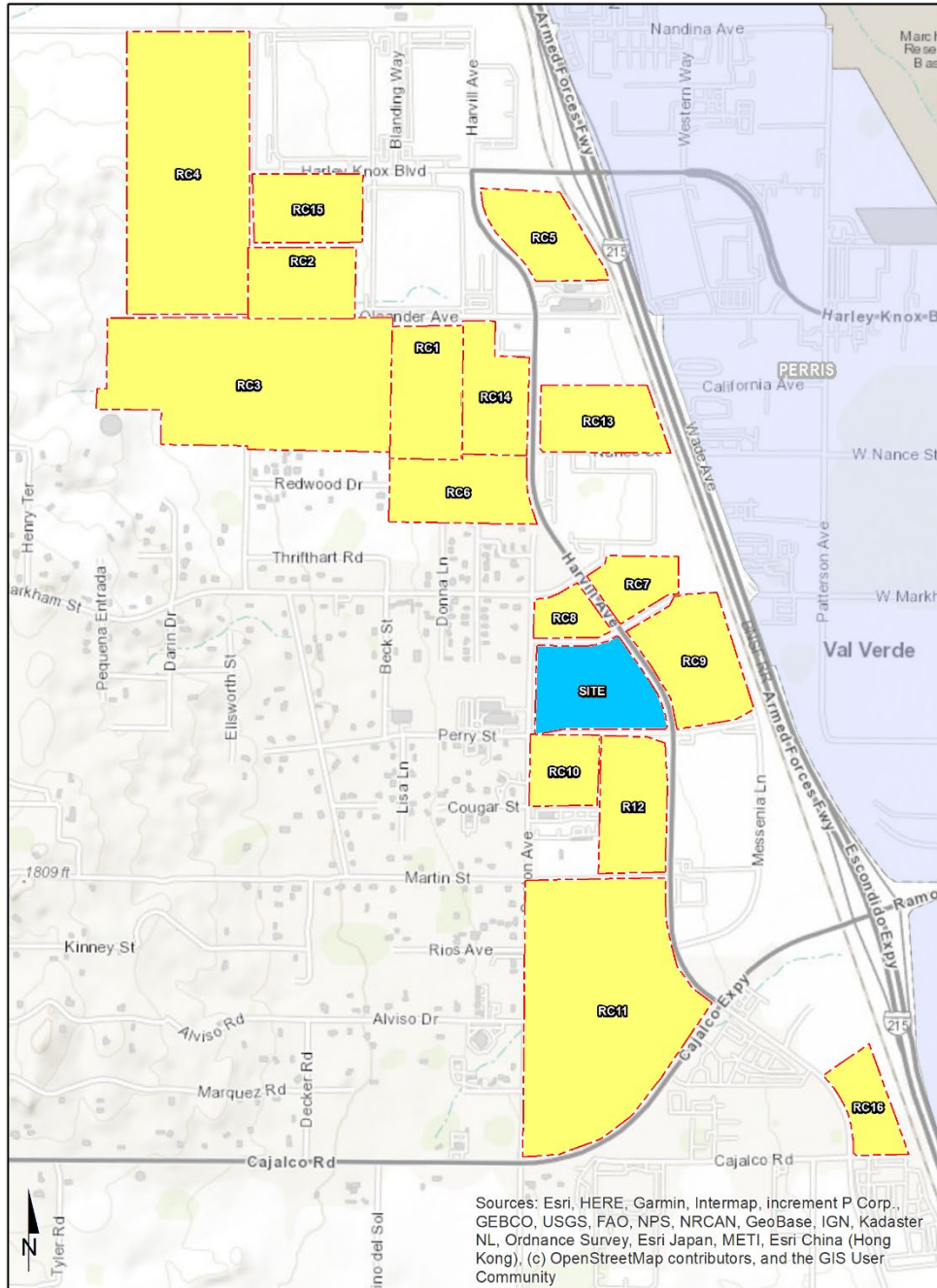



Mr. Kevin Tsang  
County of Riverside, Transportation Department  
August 9, 2022  
Page 10 of 10

## CONCLUSION

Urban Crossroads, Inc. is pleased to submit this letter documenting the Project trip generation, trip distribution, and the recommended intersection analysis locations for the Building 14A and 14B of the Majestic Freeway Business Center Specific Plan Traffic Impact Study. We will continue to move forward towards completing the traffic study after receiving jurisdiction approval or comments finalizing the study area.

If you have any questions, please contact me directly at [cso@urbanxroads.com](mailto:cso@urbanxroads.com).

Respectfully submitted,

URBAN CROSSROADS, INC.



Charlene So, PE  
Principal

## **APPENDIX 1.2: SITE ADJACENT QUEUES**

This Page Intentionally Left Blank

Intersection: 1: Harvill Av. & Driveway 1

Movement	WB	SB
Directions Served	LR	L
Maximum Queue (ft)	22	31
Average Queue (ft)	1	4
95th Queue (ft)	12	20
Link Distance (ft)	61	
Upstream Blk Time (%)		
Queuing Penalty (veh)		
Storage Bay Dist (ft)		100
Storage Blk Time (%)		
Queuing Penalty (veh)		

Intersection: 2: Harvill Av. & America's Tire

Movement	WB	WB	SB
Directions Served	L	R	L
Maximum Queue (ft)	15	31	28
Average Queue (ft)	1	4	6
95th Queue (ft)	11	22	24
Link Distance (ft)	472	472	
Upstream Blk Time (%)			
Queuing Penalty (veh)			
Storage Bay Dist (ft)			130
Storage Blk Time (%)			
Queuing Penalty (veh)			

Network Summary

Network wide Queuing Penalty: 0
---------------------------------

Intersection: 1: Harvill Av. & Driveway 1

Movement	WB	SB
Directions Served	LR	L
Maximum Queue (ft)	29	30
Average Queue (ft)	5	1
95th Queue (ft)	23	11
Link Distance (ft)	61	
Upstream Blk Time (%)		
Queuing Penalty (veh)		
Storage Bay Dist (ft)		100
Storage Blk Time (%)		
Queuing Penalty (veh)		

Intersection: 2: Harvill Av. & America's Tire

Movement	WB	WB	SB
Directions Served	L	R	L
Maximum Queue (ft)	36	31	13
Average Queue (ft)	9	8	1
95th Queue (ft)	32	31	7
Link Distance (ft)	472	472	
Upstream Blk Time (%)			
Queuing Penalty (veh)			
Storage Bay Dist (ft)			130
Storage Blk Time (%)			
Queuing Penalty (veh)			

Network Summary

Network wide Queuing Penalty: 0
---------------------------------

## **APPENDIX 3.1: TRAFFIC COUNTS**

This Page Intentionally Left Blank

**Volume Development**  
**AM Peak Hour**

**1: Harvill Av. & Driveway 1**

	PHF: 0.920		Count Date:										TOTAL
	<u>NBL</u>	<u>NBT</u>	<u>NBR</u>	<u>SBL</u>	<u>SBT</u>	<u>SBR</u>	<u>EBL</u>	<u>EBT</u>	<u>EBR</u>	<u>WBL</u>	<u>WBT</u>	<u>WBR</u>	
<b>2022 PCE:</b>	<b>0</b>	<b>451</b>	<b>0</b>	<b>0</b>	<b>276</b>	<b>0</b>	<b>0</b>	<b>0</b>	<b>0</b>	<b>0</b>	<b>0</b>	<b>0</b>	<b>727</b>
EAP 2025 PCE:	0	783	1	4	500	0	0	0	0	0	0	1	1,289
EAPC 2025 PCE:	5	1,579	1	4	955	2	1	0	1	0	0	1	2,549

**2: Harvill Av. & America's Tire Dr.**

	PHF: 0.935		Count Date: 2/8/2022										TOTAL
	<u>NBL</u>	<u>NBT</u>	<u>NBR</u>	<u>SBL</u>	<u>SBT</u>	<u>SBR</u>	<u>EBL</u>	<u>EBT</u>	<u>EBR</u>	<u>WBL</u>	<u>WBT</u>	<u>WBR</u>	
<b>2022 PCE:</b>	<b>0</b>	<b>451</b>	<b>0</b>	<b>3</b>	<b>273</b>	<b>0</b>	<b>0</b>	<b>0</b>	<b>0</b>	<b>0</b>	<b>0</b>	<b>0</b>	<b>727</b>
EAP 2025 PCE:	0	479	9	10	290	0	0	0	0	3	0	5	796
EAPC 2025 PCE:	20	1,265	9	10	704	42	15	0	7	3	0	5	2,080

**3: Harvill Av. & Cajalco Exwy.**

	PHF: 0.930		Count Date: 2/8/2022										TOTAL
	<u>NBL</u>	<u>NBT</u>	<u>NBR</u>	<u>SBL</u>	<u>SBT</u>	<u>SBR</u>	<u>EBL</u>	<u>EBT</u>	<u>EBR</u>	<u>WBL</u>	<u>WBT</u>	<u>WBR</u>	
<b>2022 PCE:</b>	<b>297</b>	<b>337</b>	<b>75</b>	<b>189</b>	<b>116</b>	<b>27</b>	<b>47</b>	<b>680</b>	<b>50</b>	<b>167</b>	<b>677</b>	<b>102</b>	<b>2,761</b>
EAP 2025 PCE:	315	359	80	203	123	28	50	721	53	177	718	115	2,941
EAPC 2025 PCE:	373	434	240	427	230	83	191	841	218	640	1,130	761	5,569

**4: I-215 SB Ramps & Ramona Exwy.**

	PHF: 0.982		Count Date: 1/25/2022										TOTAL
	<u>NBL</u>	<u>NBT</u>	<u>NBR</u>	<u>SBL</u>	<u>SBT</u>	<u>SBR</u>	<u>EBL</u>	<u>EBT</u>	<u>EBR</u>	<u>WBL</u>	<u>WBT</u>	<u>WBR</u>	
<b>2022 PCE:</b>	<b>0</b>	<b>0</b>	<b>0</b>	<b>817</b>	<b>2</b>	<b>210</b>	<b>0</b>	<b>759</b>	<b>364</b>	<b>328</b>	<b>1,121</b>	<b>0</b>	<b>3,599</b>
EAP 2025 PCE:	0	0	0	843	2	167	0	414	292	280	958	0	2,955
EAPC 2025 PCE:	0	0	0	1,847	2	780	0	785	472	547	1,877	0	6,308

**5: I-215 NB Ramps & Ramona Exwy.**

	PHF: 0.967		Count Date: 1/25/2022										TOTAL
	<u>NBL</u>	<u>NBT</u>	<u>NBR</u>	<u>SBL</u>	<u>SBT</u>	<u>SBR</u>	<u>EBL</u>	<u>EBT</u>	<u>EBR</u>	<u>WBL</u>	<u>WBT</u>	<u>WBR</u>	
<b>2022 PCE:</b>	<b>398</b>	<b>4</b>	<b>612</b>	<b>0</b>	<b>0</b>	<b>0</b>	<b>159</b>	<b>1,417</b>	<b>0</b>	<b>0</b>	<b>1,051</b>	<b>740</b>	<b>4,379</b>
EAP 2025 PCE:	322	4	487	0	0	0	126	1,136	0	0	917	589	3,582
EAPC 2025 PCE:	906	4	808	0	0	0	320	2,316	0	0	1,520	1,471	7,345



**Volume Development**  
**PM Peak Hour**

**1: Harvill Av. & Driveway 1**

	PHF: 0.920		Count Date: _____										
	<u>NBL</u>	<u>NBT</u>	<u>NBR</u>	<u>SBL</u>	<u>SBT</u>	<u>SBR</u>	<u>EBL</u>	<u>EBT</u>	<u>EBR</u>	<u>WBL</u>	<u>WBT</u>	<u>WBR</u>	<u>TOTAL</u>
<b>2022 PCE:</b>	<b>0</b>	<b>361</b>	<b>0</b>	<b>0</b>	<b>366</b>	<b>0</b>	<b>0</b>	<b>0</b>	<b>0</b>	<b>0</b>	<b>0</b>	<b>0</b>	<b>727</b>
EAP 2025 PCE:	0	588	1	2	691	0	0	0	0	2	0	5	1,289
EAPC 2025 PCE:	2	1,106	1	2	1,538	1	4	0	4	2	0	5	2,665

**2: Harvill Av. & America's Tire Dr.**

	PHF: 0.895		Count Date: 2/8/2022										
	<u>NBL</u>	<u>NBT</u>	<u>NBR</u>	<u>SBL</u>	<u>SBT</u>	<u>SBR</u>	<u>EBL</u>	<u>EBT</u>	<u>EBR</u>	<u>WBL</u>	<u>WBT</u>	<u>WBR</u>	<u>TOTAL</u>
<b>2022 PCE:</b>	<b>0</b>	<b>355</b>	<b>1</b>	<b>0</b>	<b>366</b>	<b>0</b>	<b>0</b>	<b>0</b>	<b>0</b>	<b>0</b>	<b>0</b>	<b>6</b>	<b>728</b>
EAP 2025 PCE:	0	378	5	3	390	0	0	0	0	10	0	11	797
EAPC 2025 PCE:	9	855	5	3	1,224	17	42	0	21	10	0	11	2,198

**3: Harvill Av. & Cajalco Exwy.**

	PHF: 0.934		Count Date: 2/8/2022										
	<u>NBL</u>	<u>NBT</u>	<u>NBR</u>	<u>SBL</u>	<u>SBT</u>	<u>SBR</u>	<u>EBL</u>	<u>EBT</u>	<u>EBR</u>	<u>WBL</u>	<u>WBT</u>	<u>WBR</u>	<u>TOTAL</u>
<b>2022 PCE:</b>	<b>165</b>	<b>144</b>	<b>125</b>	<b>222</b>	<b>211</b>	<b>35</b>	<b>24</b>	<b>723</b>	<b>207</b>	<b>132</b>	<b>637</b>	<b>187</b>	<b>2,811</b>
EAP 2025 PCE:	175	154	132	243	227	39	26	767	220	140	676	201	3,000
EAPC 2025 PCE:	312	241	591	920	321	176	125	1,238	297	350	929	477	5,976

**4: I-215 SB Ramps & Ramona Exwy.**

	PHF: 0.990		Count Date: 1/25/2022										
	<u>NBL</u>	<u>NBT</u>	<u>NBR</u>	<u>SBL</u>	<u>SBT</u>	<u>SBR</u>	<u>EBL</u>	<u>EBT</u>	<u>EBR</u>	<u>WBL</u>	<u>WBT</u>	<u>WBR</u>	<u>TOTAL</u>
<b>2022 PCE:</b>	<b>0</b>	<b>0</b>	<b>0</b>	<b>853</b>	<b>8</b>	<b>184</b>	<b>0</b>	<b>911</b>	<b>348</b>	<b>369</b>	<b>915</b>	<b>0</b>	<b>3,586</b>
EAP 2025 PCE:	0	0	0	802	8	146	0	634	283	322	748	0	2,943
EAPC 2025 PCE:	0	0	0	2,002	8	418	0	1,622	899	844	1,240	0	7,032

**5: I-215 NB Ramps & Ramona Exwy.**

	PHF: 0.940		Count Date: 1/25/2022										
	<u>NBL</u>	<u>NBT</u>	<u>NBR</u>	<u>SBL</u>	<u>SBT</u>	<u>SBR</u>	<u>EBL</u>	<u>EBT</u>	<u>EBR</u>	<u>WBL</u>	<u>WBT</u>	<u>WBR</u>	<u>TOTAL</u>
<b>2022 PCE:</b>	<b>371</b>	<b>4</b>	<b>461</b>	<b>0</b>	<b>0</b>	<b>0</b>	<b>121</b>	<b>1,643</b>	<b>0</b>	<b>0</b>	<b>913</b>	<b>652</b>	<b>4,164</b>
EAP 2025 PCE:	298	4	367	0	0	0	96	1,343	0	0	774	519	3,402
EAPC 2025 PCE:	590	4	561	0	0	0	695	2,932	0	0	1,497	1,722	8,001

County of Riverside  
 N/S: Harvill Avenue  
 E/W: Americas Tire Drive  
 Weather: Clear

File Name : 04\_CRV\_Har\_Am T AM  
 Site Code : 05122112  
 Start Date : 2/8/2022  
 Page No : 1

Groups Printed- Passenger Vehicles - Large 2 Axle Vehicles - 3 Axle Vehicles - 4+ Axle Trucks

Start Time	Harvill Avenue Southbound			Americas Tire Drive Westbound			Harvill Avenue Northbound			Int. Total
	Left	Thru	App. Total	Left	Right	App. Total	Thru	Right	App. Total	
07:00 AM	0	44	44	0	0	0	89	0	89	133
07:15 AM	0	57	57	0	0	0	103	0	103	160
07:30 AM	1	63	64	0	0	0	98	0	98	162
07:45 AM	1	65	66	0	0	0	110	0	110	176
Total	2	229	231	0	0	0	400	0	400	631
08:00 AM	1	60	61	0	0	0	99	0	99	160
08:15 AM	1	46	47	0	1	1	73	1	74	122
08:30 AM	0	27	27	0	0	0	82	0	82	109
08:45 AM	1	26	27	0	0	0	54	0	54	81
Total	3	159	162	0	1	1	308	1	309	472
Grand Total	5	388	393	0	1	1	708	1	709	1103
Apprch %	1.3	98.7		0	100		99.9	0.1		
Total %	0.5	35.2	35.6	0	0.1	0.1	64.2	0.1	64.3	
Passenger Vehicles	4	343	347	0	1	1	649	1	650	998
% Passenger Vehicles	80	88.4	88.3	0	100	100	91.7	100	91.7	90.5
Large 2 Axle Vehicles	1	20	21	0	0	0	26	0	26	47
% Large 2 Axle Vehicles	20	5.2	5.3	0	0	0	3.7	0	3.7	4.3
3 Axle Vehicles	0	3	3	0	0	0	8	0	8	11
% 3 Axle Vehicles	0	0.8	0.8	0	0	0	1.1	0	1.1	1
4+ Axle Trucks	0	22	22	0	0	0	25	0	25	47
% 4+ Axle Trucks	0	5.7	5.6	0	0	0	3.5	0	3.5	4.3

Start Time	Harvill Avenue Southbound			Americas Tire Drive Westbound			Harvill Avenue Northbound			Int. Total
	Left	Thru	App. Total	Left	Right	App. Total	Thru	Right	App. Total	
Peak Hour Analysis From 07:00 AM to 08:45 AM - Peak 1 of 1										
Peak Hour for Entire Intersection Begins at 07:15 AM										
07:15 AM	0	57	57	0	0	0	103	0	103	160
07:30 AM	1	63	64	0	0	0	98	0	98	162
07:45 AM	1	65	66	0	0	0	110	0	110	176
08:00 AM	1	60	61	0	0	0	99	0	99	160
Total Volume	3	245	248	0	0	0	410	0	410	658
% App. Total	1.2	98.8		0	0		100	0		
PHF	.750	.942	.939	.000	.000	.000	.932	.000	.932	.935

County of Riverside  
 N/S: Harvill Avenue  
 E/W: Americas Tire Drive  
 Weather: Clear

File Name : 04\_CRV\_Har\_Am T AM  
 Site Code : 05122112  
 Start Date : 2/8/2022  
 Page No : 2

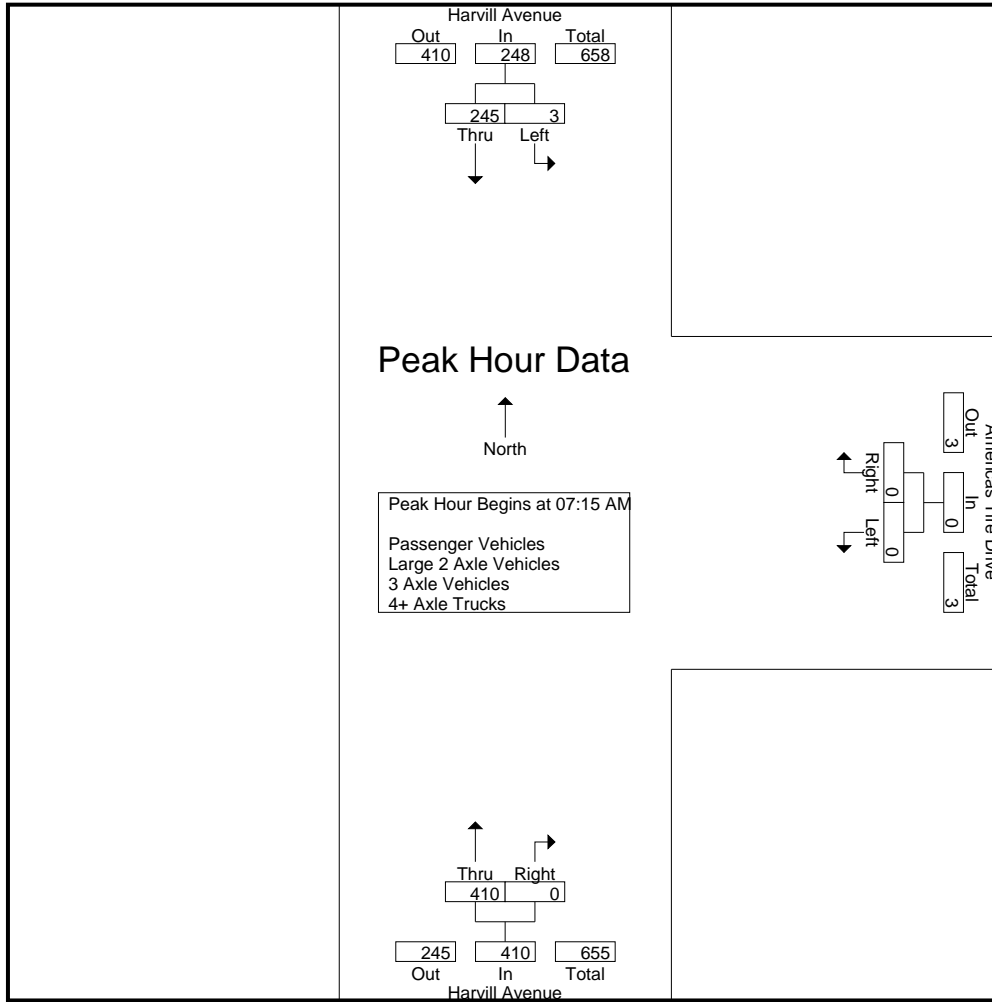

Peak Hour Analysis From 07:00 AM to 08:45 AM - Peak 1 of 1  
 Peak Hour for Each Approach Begins at:

	07:15 AM			07:30 AM			07:45 AM		
+0 mins.	0	57	57	0	0	0	103	0	103
+15 mins.	1	63	64	0	0	0	98	0	98
+30 mins.	1	<b>65</b>	<b>66</b>	0	0	0	<b>110</b>	0	<b>110</b>
+45 mins.	1	60	61	0	1	1	99	0	99
Total Volume	3	245	248	0	1	1	410	0	410
% App. Total	1.2	98.8		0	100		100	0	
PHF	.750	.942	.939	.000	.250	.250	.932	.000	.932

County of Riverside  
 N/S: Harvill Avenue  
 E/W: Americas Tire Drive  
 Weather: Clear

File Name : 04\_CRV\_Har\_Am T AM  
 Site Code : 05122112  
 Start Date : 2/8/2022  
 Page No : 1

Groups Printed- Large 2 Axle Vehicles

Start Time	Harvill Avenue Southbound			Americas Tire Drive Westbound			Harvill Avenue Northbound			Int. Total
	Left	Thru	App. Total	Left	Right	App. Total	Thru	Right	App. Total	
07:00 AM	0	0	0	0	0	0	2	0	2	2
07:15 AM	0	2	2	0	0	0	10	0	10	12
07:30 AM	0	5	5	0	0	0	4	0	4	9
07:45 AM	0	3	3	0	0	0	1	0	1	4
Total	0	10	10	0	0	0	17	0	17	27
08:00 AM	0	0	0	0	0	0	4	0	4	4
08:15 AM	1	5	6	0	0	0	1	0	1	7
08:30 AM	0	3	3	0	0	0	3	0	3	6
08:45 AM	0	2	2	0	0	0	1	0	1	3
Total	1	10	11	0	0	0	9	0	9	20
Grand Total	1	20	21	0	0	0	26	0	26	47
Apprch %	4.8	95.2		0	0		100	0		
Total %	2.1	42.6	44.7	0	0	0	55.3	0	55.3	

Start Time	Harvill Avenue Southbound			Americas Tire Drive Westbound			Harvill Avenue Northbound			Int. Total
	Left	Thru	App. Total	Left	Right	App. Total	Thru	Right	App. Total	
07:15 AM	0	2	2	0	0	0	<b>10</b>	0	<b>10</b>	<b>12</b>
07:30 AM	0	5	5	0	0	0	4	0	4	9
07:45 AM	0	3	3	0	0	0	1	0	1	4
08:00 AM	0	0	0	0	0	0	4	0	4	4
Total Volume	0	10	10	0	0	0	19	0	19	29
% App. Total	0	100		0	0		100	0		
PHF	.000	.500	.500	.000	.000	.000	.475	.000	.475	.604

Peak Hour Analysis From 07:15 AM to 08:00 AM - Peak 1 of 1

Peak Hour for Entire Intersection Begins at 07:15 AM

County of Riverside  
 N/S: Harvill Avenue  
 E/W: Americas Tire Drive  
 Weather: Clear

File Name : 04\_CRV\_Har\_Am T AM  
 Site Code : 05122112  
 Start Date : 2/8/2022  
 Page No : 2

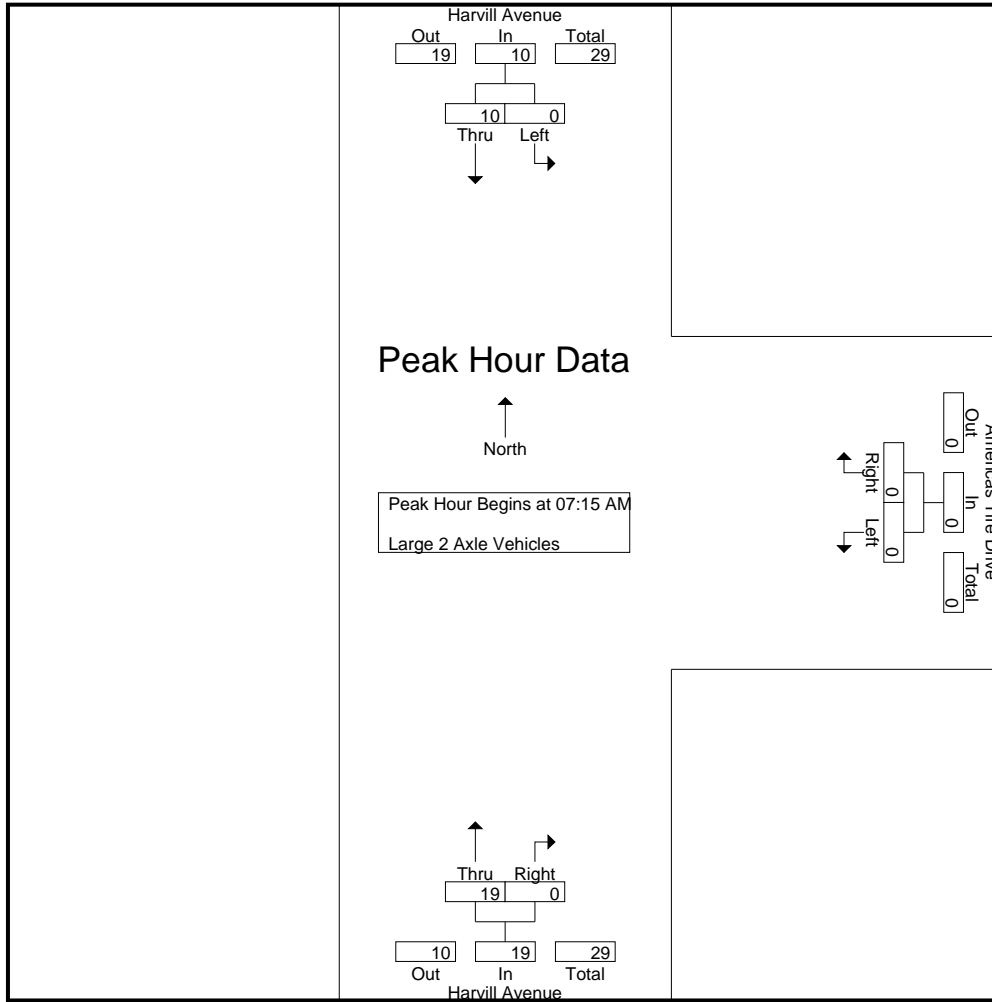

Peak Hour Analysis From 07:15 AM to 08:00 AM - Peak 1 of 1  
 Peak Hour for Each Approach Begins at:

	07:15 AM			07:15 AM			07:15 AM		
+0 mins.	0	2	2	0	0	0	<b>10</b>	0	<b>10</b>
+15 mins.	0	<b>5</b>	<b>5</b>	0	0	0	4	0	4
+30 mins.	0	3	3	0	0	0	1	0	1
+45 mins.	0	0	0	0	0	0	4	0	4
Total Volume	0	10	10	0	0	0	19	0	19
% App. Total	0	100		0	0		100	0	
PHF	.000	.500	.500	.000	.000	.000	.475	.000	.475

County of Riverside  
 N/S: Harvill Avenue  
 E/W: Americas Tire Drive  
 Weather: Clear

File Name : 04\_CRV\_Har\_Am T AM  
 Site Code : 05122112  
 Start Date : 2/8/2022  
 Page No : 1

Groups Printed- 3 Axle Vehicles

Start Time	Harvill Avenue Southbound			Americas Tire Drive Westbound			Harvill Avenue Northbound			Int. Total
	Left	Thru	App. Total	Left	Right	App. Total	Thru	Right	App. Total	
07:00 AM	0	0	0	0	0	0	0	0	0	0
07:15 AM	0	0	0	0	0	0	2	0	2	2
07:30 AM	0	0	0	0	0	0	1	0	1	1
07:45 AM	0	0	0	0	0	0	0	0	0	0
Total	0	0	0	0	0	0	3	0	3	3
08:00 AM	0	0	0	0	0	0	0	0	0	0
08:15 AM	0	0	0	0	0	0	2	0	2	2
08:30 AM	0	1	1	0	0	0	1	0	1	2
08:45 AM	0	2	2	0	0	0	2	0	2	4
Total	0	3	3	0	0	0	5	0	5	8
Grand Total	0	3	3	0	0	0	8	0	8	11
Apprch %	0	100		0	0		100	0		
Total %	0	27.3	27.3	0	0	0	72.7	0	72.7	

Start Time	Harvill Avenue Southbound			Americas Tire Drive Westbound			Harvill Avenue Northbound			Int. Total
	Left	Thru	App. Total	Left	Right	App. Total	Thru	Right	App. Total	
07:15 AM	0	0	0	0	0	0	2	0	2	2
07:30 AM	0	0	0	0	0	0	1	0	1	1
07:45 AM	0	0	0	0	0	0	0	0	0	0
08:00 AM	0	0	0	0	0	0	0	0	0	0
Total Volume	0	0	0	0	0	0	3	0	3	3
% App. Total	0	0		0	0		100	0		
PHF	.000	.000	.000	.000	.000	.000	.375	.000	.375	.375

Peak Hour Analysis From 07:15 AM to 08:00 AM - Peak 1 of 1  
 Peak Hour for Entire Intersection Begins at 07:15 AM

County of Riverside  
 N/S: Harvill Avenue  
 E/W: Americas Tire Drive  
 Weather: Clear

File Name : 04\_CRV\_Har\_Am T AM  
 Site Code : 05122112  
 Start Date : 2/8/2022  
 Page No : 2

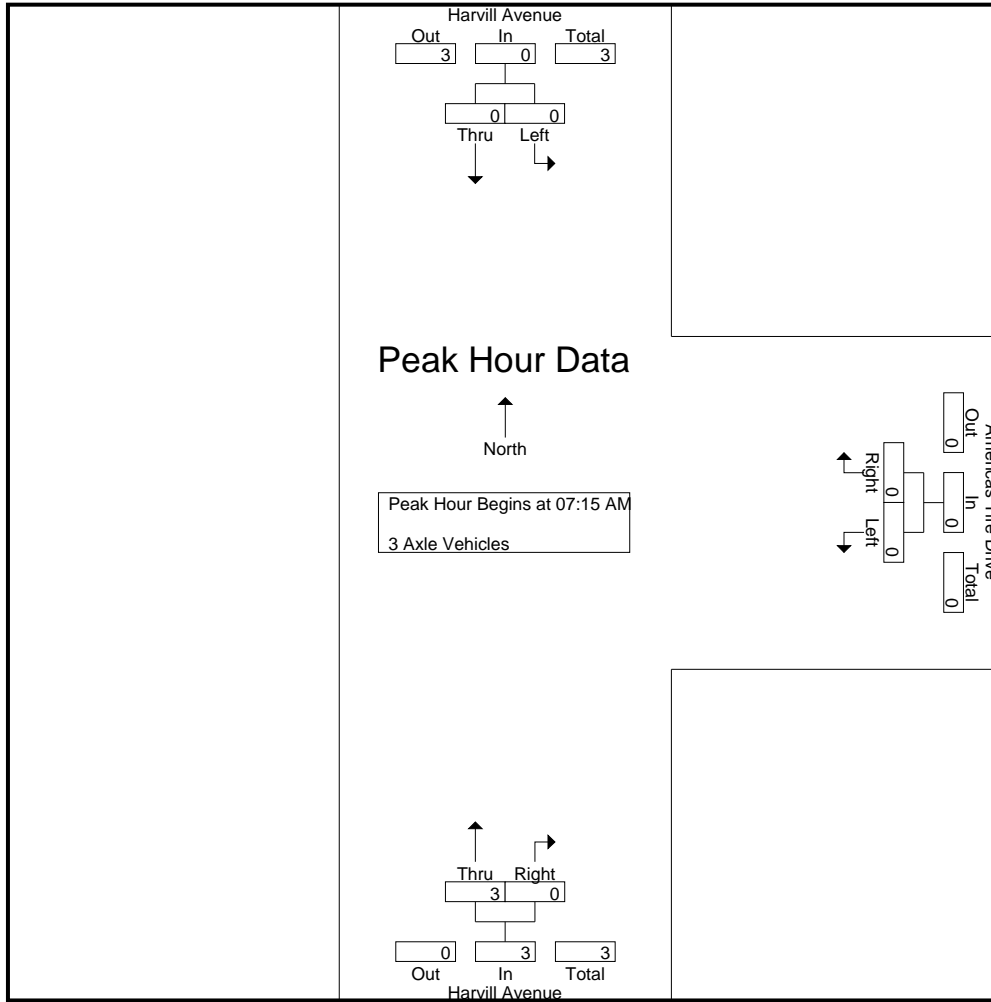

Peak Hour Analysis From 07:15 AM to 08:00 AM - Peak 1 of 1  
 Peak Hour for Each Approach Begins at:

	07:15 AM			07:15 AM			07:15 AM		
+0 mins.	0	0	0	0	0	0	<b>2</b>	0	<b>2</b>
+15 mins.	0	0	0	0	0	0	1	0	1
+30 mins.	0	0	0	0	0	0	0	0	0
+45 mins.	0	0	0	0	0	0	0	0	0
Total Volume	0	0	0	0	0	0	3	0	3
% App. Total	0	0	0	0	0	0	100	0	
PHF	.000	.000	.000	.000	.000	.000	.375	.000	.375



County of Riverside  
 N/S: Harvill Avenue  
 E/W: Americas Tire Drive  
 Weather: Clear

File Name : 04\_CRV\_Har\_Am T AM  
 Site Code : 05122112  
 Start Date : 2/8/2022  
 Page No : 1

Groups Printed- 4+ Axle Trucks

Start Time	Harvill Avenue Southbound			Americas Tire Drive Westbound			Harvill Avenue Northbound			Int. Total
	Left	Thru	App. Total	Left	Right	App. Total	Thru	Right	App. Total	
07:00 AM	0	3	3	0	0	0	3	0	3	6
07:15 AM	0	3	3	0	0	0	2	0	2	5
07:30 AM	0	2	2	0	0	0	3	0	3	5
07:45 AM	0	3	3	0	0	0	3	0	3	6
Total	0	11	11	0	0	0	11	0	11	22
08:00 AM	0	0	0	0	0	0	5	0	5	5
08:15 AM	0	6	6	0	0	0	3	0	3	9
08:30 AM	0	3	3	0	0	0	0	0	0	3
08:45 AM	0	2	2	0	0	0	6	0	6	8
Total	0	11	11	0	0	0	14	0	14	25
Grand Total	0	22	22	0	0	0	25	0	25	47
Apprch %	0	100		0	0		100	0		
Total %	0	46.8	46.8	0	0	0	53.2	0	53.2	

Start Time	Harvill Avenue Southbound			Americas Tire Drive Westbound			Harvill Avenue Northbound			Int. Total
	Left	Thru	App. Total	Left	Right	App. Total	Thru	Right	App. Total	
07:15 AM	0	3	3	0	0	0	2	0	2	5
07:30 AM	0	2	2	0	0	0	3	0	3	5
07:45 AM	0	3	3	0	0	0	3	0	3	6
08:00 AM	0	0	0	0	0	0	5	0	5	5
Total Volume	0	8	8	0	0	0	13	0	13	21
% App. Total	0	100		0	0		100	0		
PHF	.000	.667	.667	.000	.000	.000	.650	.000	.650	.875

Peak Hour Analysis From 07:15 AM to 08:00 AM - Peak 1 of 1

Peak Hour for Entire Intersection Begins at 07:15 AM

County of Riverside  
 N/S: Harvill Avenue  
 E/W: Americas Tire Drive  
 Weather: Clear

File Name : 04\_CRV\_Har\_Am T AM  
 Site Code : 05122112  
 Start Date : 2/8/2022  
 Page No : 2

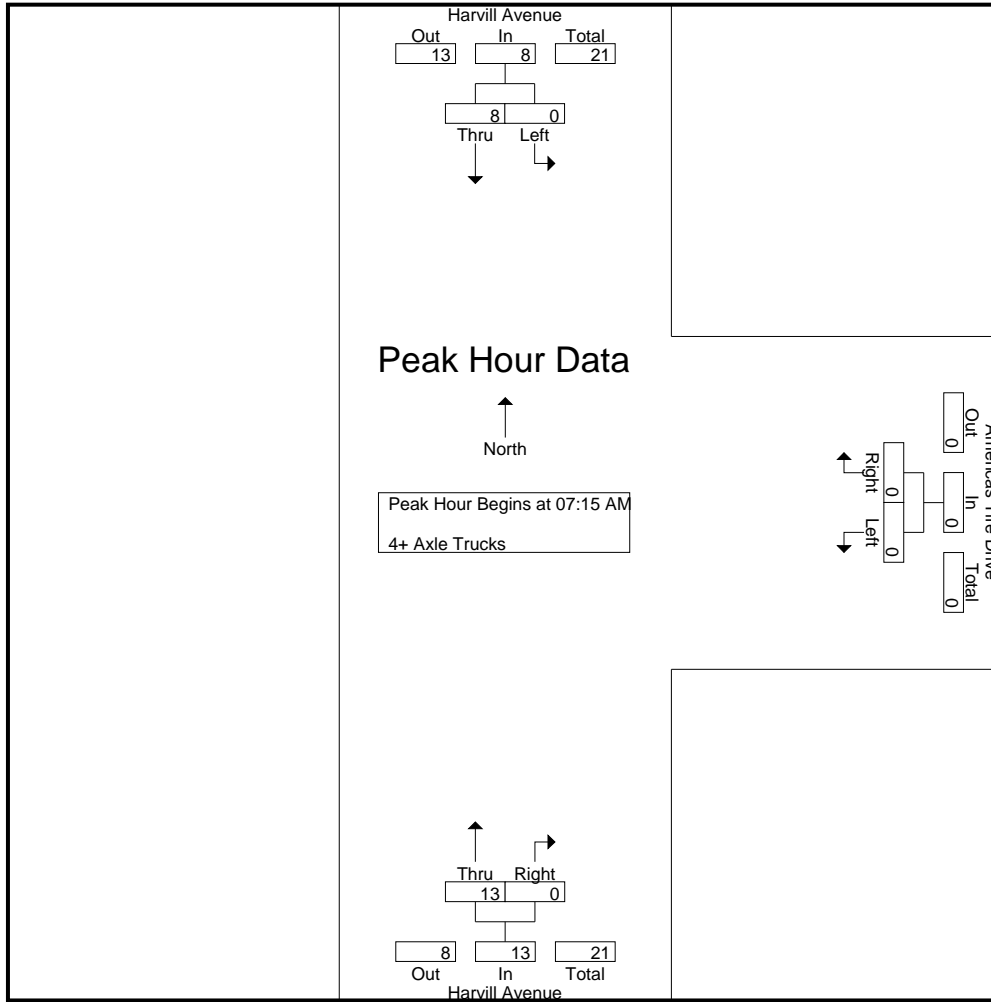

Peak Hour Analysis From 07:15 AM to 08:00 AM - Peak 1 of 1  
 Peak Hour for Each Approach Begins at:

	07:15 AM			07:15 AM			07:15 AM		
+0 mins.	0	3	3	0	0	0	2	0	2
+15 mins.	0	2	2	0	0	0	3	0	3
+30 mins.	0	3	3	0	0	0	3	0	3
+45 mins.	0	0	0	0	0	0	5	0	5
Total Volume	0	8	8	0	0	0	13	0	13
% App. Total	0	100		0	0		100	0	
PHF	.000	.667	.667	.000	.000	.000	.650	.000	.650

County of Riverside  
 N/S: Harvill Avenue  
 E/W: Americas Tire Drive  
 Weather: Clear

File Name : 04\_CRV\_Har\_Am T PM  
 Site Code : 05122112  
 Start Date : 2/8/2022  
 Page No : 1

Groups Printed- Passenger Vehicles - Large 2 Axle Vehicles - 3 Axle Vehicles - 4+ Axle Trucks

Start Time	Harvill Avenue Southbound			Americas Tire Drive Westbound			Harvill Avenue Northbound			Int. Total
	Left	Thru	App. Total	Left	Right	App. Total	Thru	Right	App. Total	
04:00 PM	0	78	78	0	1	1	100	0	100	179
04:15 PM	0	73	73	0	0	0	79	1	80	153
04:30 PM	0	87	87	0	3	3	94	0	94	184
04:45 PM	0	82	82	0	2	2	59	0	59	143
Total	0	320	320	0	6	6	332	1	333	659
05:00 PM	0	76	76	0	0	0	78	0	78	154
05:15 PM	0	76	76	0	0	0	75	0	75	151
05:30 PM	0	83	83	0	0	0	72	0	72	155
05:45 PM	0	60	60	0	0	0	64	0	64	124
Total	0	295	295	0	0	0	289	0	289	584
Grand Total	0	615	615	0	6	6	621	1	622	1243
Apprch %	0	100		0	100		99.8	0.2		
Total %	0	49.5	49.5	0	0.5	0.5	50	0.1	50	
Passenger Vehicles	0	567	567	0	6	6	583	1	584	1157
% Passenger Vehicles	0	92.2	92.2	0	100	100	93.9	100	93.9	93.1
Large 2 Axle Vehicles	0	15	15	0	0	0	13	0	13	28
% Large 2 Axle Vehicles	0	2.4	2.4	0	0	0	2.1	0	2.1	2.3
3 Axle Vehicles	0	12	12	0	0	0	19	0	19	31
% 3 Axle Vehicles	0	2	2	0	0	0	3.1	0	3.1	2.5
4+ Axle Trucks	0	21	21	0	0	0	6	0	6	27
% 4+ Axle Trucks	0	3.4	3.4	0	0	0	1	0	1	2.2

Start Time	Harvill Avenue Southbound			Americas Tire Drive Westbound			Harvill Avenue Northbound			Int. Total
	Left	Thru	App. Total	Left	Right	App. Total	Thru	Right	App. Total	
04:00 PM	0	78	78	0	1	1	<b>100</b>	0	<b>100</b>	179
04:15 PM	0	73	73	0	0	0	79	1	80	153
04:30 PM	0	<b>87</b>	<b>87</b>	0	<b>3</b>	<b>3</b>	94	0	94	<b>184</b>
04:45 PM	0	82	82	0	2	2	59	0	59	143
Total Volume	0	320	320	0	6	6	332	1	333	659
% App. Total	0	100		0	100		99.7	0.3		
PHF	.000	.920	.920	.000	.500	.500	.830	.250	.833	.895

Peak Hour Analysis From 04:00 PM to 05:45 PM - Peak 1 of 1

Peak Hour for Entire Intersection Begins at 04:00 PM

County of Riverside  
 N/S: Harvill Avenue  
 E/W: Americas Tire Drive  
 Weather: Clear

File Name : 04\_CRV\_Har\_Am T PM  
 Site Code : 05122112  
 Start Date : 2/8/2022  
 Page No : 2

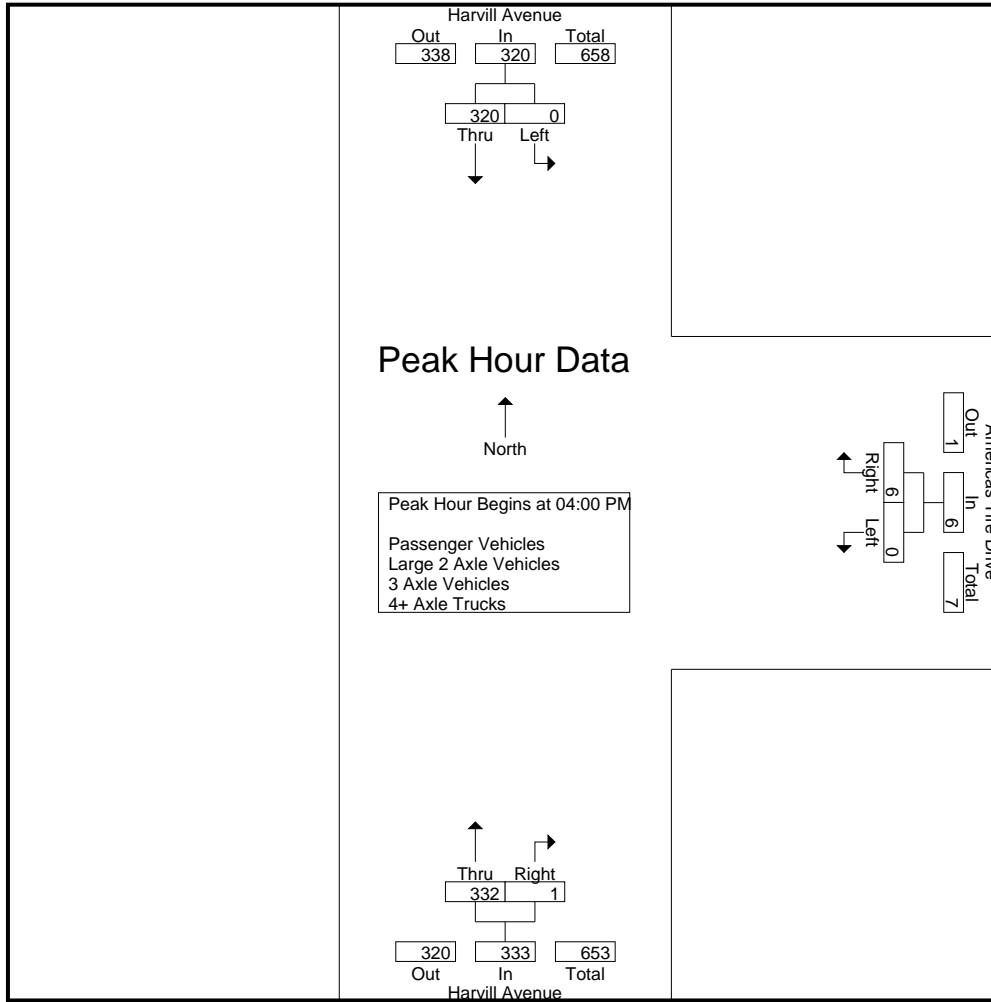

Peak Hour Analysis From 04:00 PM to 05:45 PM - Peak 1 of 1  
 Peak Hour for Each Approach Begins at:

	04:30 PM			04:00 PM			04:00 PM		
+0 mins.	0	<b>87</b>	<b>87</b>	0	1	1	<b>100</b>	0	<b>100</b>
+15 mins.	0	82	82	0	0	0	79	1	80
+30 mins.	0	76	76	0	3	3	94	0	94
+45 mins.	0	76	76	0	2	2	59	0	59
Total Volume	0	321	321	0	6	6	332	1	333
% App. Total	0	100		0	100		99.7	0.3	
PHF	.000	.922	.922	.000	.500	.500	.830	.250	.833

County of Riverside  
 N/S: Harvill Avenue  
 E/W: Americas Tire Drive  
 Weather: Clear

File Name : 04\_CRV\_Har\_Am T PM  
 Site Code : 05122112  
 Start Date : 2/8/2022  
 Page No : 1

Groups Printed- Large 2 Axle Vehicles

Start Time	Harvill Avenue Southbound			Americas Tire Drive Westbound			Harvill Avenue Northbound			Int. Total
	Left	Thru	App. Total	Left	Right	App. Total	Thru	Right	App. Total	
04:00 PM	0	6	6	0	0	0	4	0	4	10
04:15 PM	0	1	1	0	0	0	0	0	0	1
04:30 PM	0	2	2	0	0	0	1	0	1	3
04:45 PM	0	2	2	0	0	0	1	0	1	3
Total	0	11	11	0	0	0	6	0	6	17
05:00 PM	0	1	1	0	0	0	1	0	1	2
05:15 PM	0	0	0	0	0	0	2	0	2	2
05:30 PM	0	3	3	0	0	0	4	0	4	7
05:45 PM	0	0	0	0	0	0	0	0	0	0
Total	0	4	4	0	0	0	7	0	7	11
Grand Total	0	15	15	0	0	0	13	0	13	28
Apprch %	0	100		0	0		100	0		
Total %	0	53.6	53.6	0	0	0	46.4	0	46.4	

Start Time	Harvill Avenue Southbound			Americas Tire Drive Westbound			Harvill Avenue Northbound			Int. Total
	Left	Thru	App. Total	Left	Right	App. Total	Thru	Right	App. Total	
04:00 PM	0	6	6	0	0	0	4	0	4	10
04:15 PM	0	1	1	0	0	0	0	0	0	1
04:30 PM	0	2	2	0	0	0	1	0	1	3
04:45 PM	0	2	2	0	0	0	1	0	1	3
Total Volume	0	11	11	0	0	0	6	0	6	17
% App. Total	0	100		0	0		100	0		
PHF	.000	.458	.458	.000	.000	.000	.375	.000	.375	.425

Peak Hour Analysis From 04:00 PM to 04:45 PM - Peak 1 of 1

Peak Hour for Entire Intersection Begins at 04:00 PM

County of Riverside  
 N/S: Harvill Avenue  
 E/W: Americas Tire Drive  
 Weather: Clear

File Name : 04\_CRV\_Har\_Am T PM  
 Site Code : 05122112  
 Start Date : 2/8/2022  
 Page No : 2

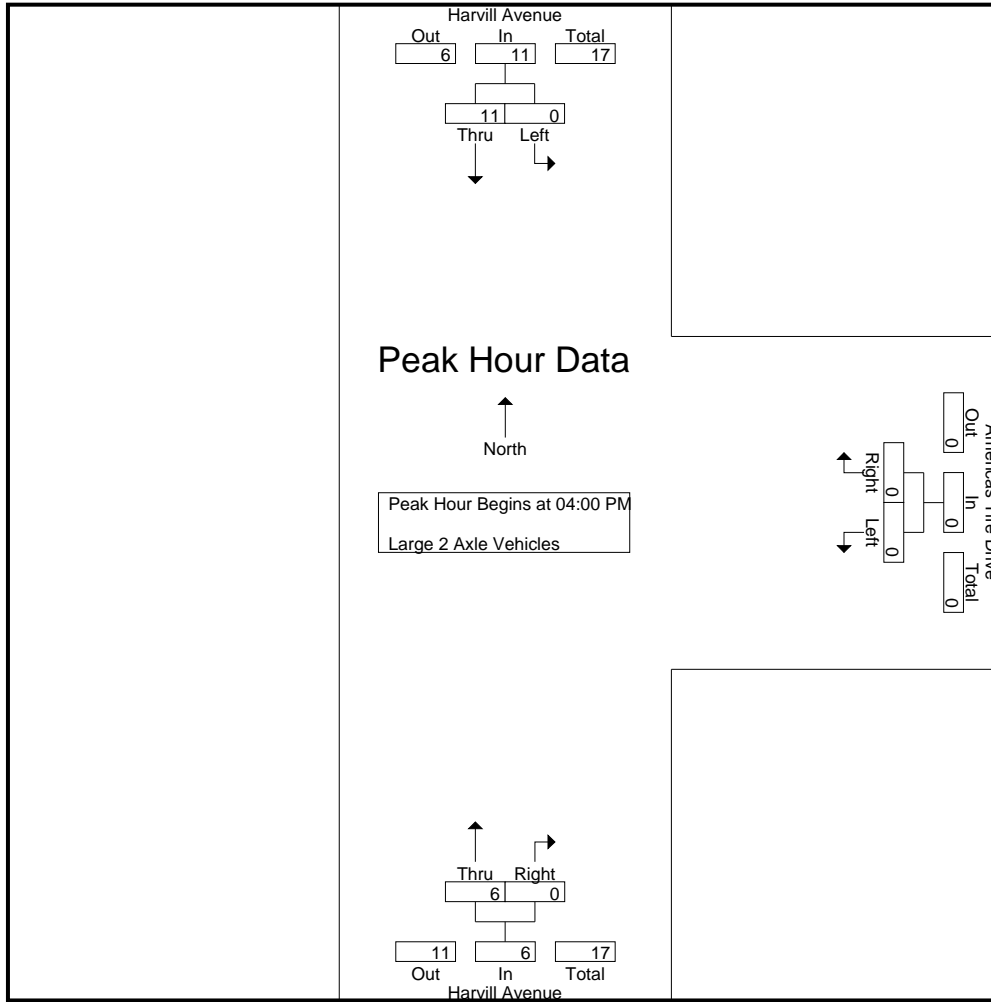

Peak Hour Analysis From 04:00 PM to 04:45 PM - Peak 1 of 1  
 Peak Hour for Each Approach Begins at:

	04:00 PM			04:00 PM			04:00 PM		
+0 mins.	0	<b>6</b>	<b>6</b>	0	0	0	<b>4</b>	0	<b>4</b>
+15 mins.	0	1	1	0	0	0	0	0	0
+30 mins.	0	2	2	0	0	0	1	0	1
+45 mins.	0	2	2	0	0	0	1	0	1
Total Volume	0	11	11	0	0	0	6	0	6
% App. Total	0	100		0	0		100	0	
PHF	.000	.458	.458	.000	.000	.000	.375	.000	.375

County of Riverside  
 N/S: Harvill Avenue  
 E/W: Americas Tire Drive  
 Weather: Clear

File Name : 04\_CRV\_Har\_Am T PM  
 Site Code : 05122112  
 Start Date : 2/8/2022  
 Page No : 1

Groups Printed- 3 Axle Vehicles

Start Time	Harvill Avenue Southbound			Americas Tire Drive Westbound			Harvill Avenue Northbound			Int. Total
	Left	Thru	App. Total	Left	Right	App. Total	Thru	Right	App. Total	
04:00 PM	0	2	2	0	0	0	4	0	4	6
04:15 PM	0	4	4	0	0	0	4	0	4	8
04:30 PM	0	2	2	0	0	0	2	0	2	4
04:45 PM	0	2	2	0	0	0	1	0	1	3
Total	0	10	10	0	0	0	11	0	11	21
05:00 PM	0	0	0	0	0	0	1	0	1	1
05:15 PM	0	2	2	0	0	0	6	0	6	8
05:30 PM	0	0	0	0	0	0	0	0	0	0
05:45 PM	0	0	0	0	0	0	1	0	1	1
Total	0	2	2	0	0	0	8	0	8	10
Grand Total	0	12	12	0	0	0	19	0	19	31
Apprch %	0	100		0	0		100	0		
Total %	0	38.7	38.7	0	0	0	61.3	0	61.3	

Start Time	Harvill Avenue Southbound			Americas Tire Drive Westbound			Harvill Avenue Northbound			Int. Total
	Left	Thru	App. Total	Left	Right	App. Total	Thru	Right	App. Total	
04:00 PM	0	2	2	0	0	0	4	0	4	6
04:15 PM	0	4	4	0	0	0	4	0	4	8
04:30 PM	0	2	2	0	0	0	2	0	2	4
04:45 PM	0	2	2	0	0	0	1	0	1	3
Total Volume	0	10	10	0	0	0	11	0	11	21
% App. Total	0	100		0	0		100	0		
PHF	.000	.625	.625	.000	.000	.000	.688	.000	.688	.656

Peak Hour Analysis From 04:00 PM to 04:45 PM - Peak 1 of 1

Peak Hour for Entire Intersection Begins at 04:00 PM

County of Riverside  
 N/S: Harvill Avenue  
 E/W: Americas Tire Drive  
 Weather: Clear

File Name : 04\_CRV\_Har\_Am T PM  
 Site Code : 05122112  
 Start Date : 2/8/2022  
 Page No : 2

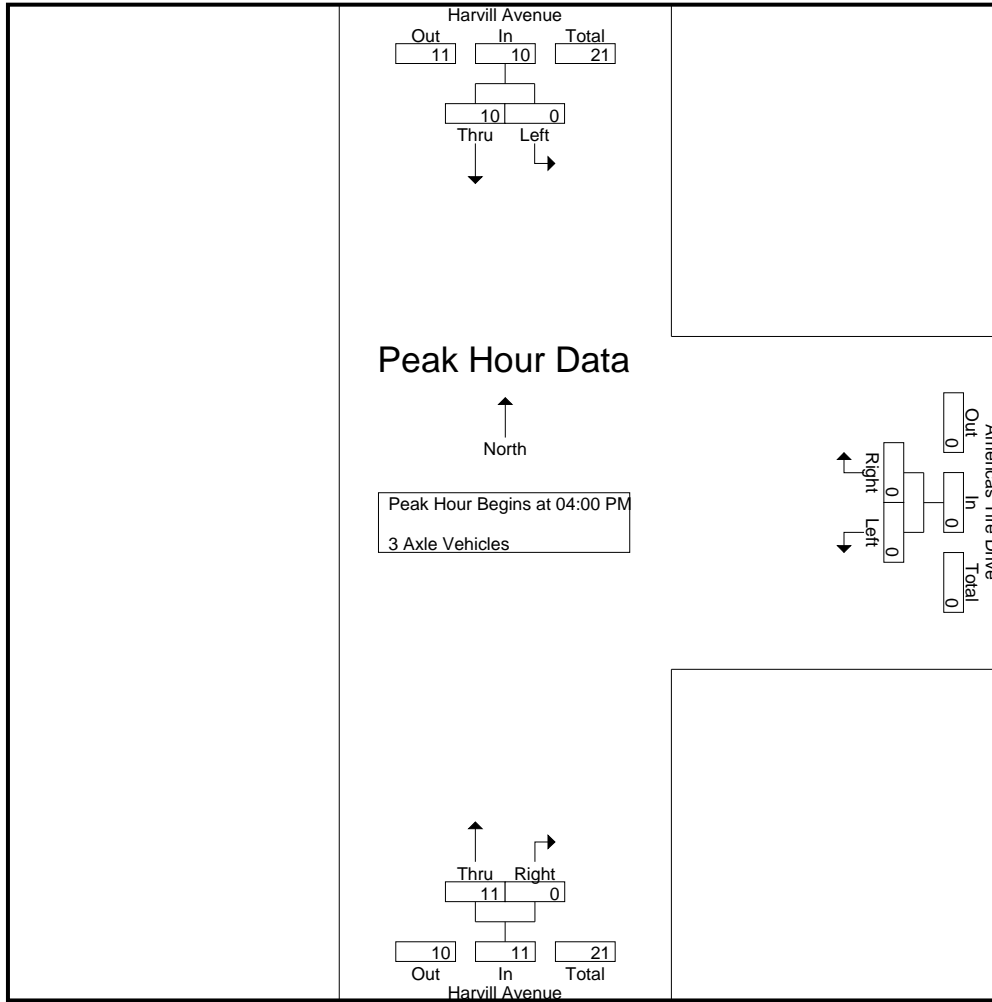

Peak Hour Analysis From 04:00 PM to 04:45 PM - Peak 1 of 1  
 Peak Hour for Each Approach Begins at:

	04:00 PM			04:00 PM			04:00 PM		
+0 mins.	0	2	2	0	0	0	4	0	4
+15 mins.	0	4	4	0	0	0	4	0	4
+30 mins.	0	2	2	0	0	0	2	0	2
+45 mins.	0	2	2	0	0	0	1	0	1
Total Volume	0	10	10	0	0	0	11	0	11
% App. Total	0	100		0	0		100	0	
PHF	.000	.625	.625	.000	.000	.000	.688	.000	.688



County of Riverside  
 N/S: Harvill Avenue  
 E/W: Americas Tire Drive  
 Weather: Clear

File Name : 04\_CRV\_Har\_Am T PM  
 Site Code : 05122112  
 Start Date : 2/8/2022  
 Page No : 1

Groups Printed- 4+ Axle Trucks

Start Time	Harvill Avenue Southbound			Americas Tire Drive Westbound			Harvill Avenue Northbound			Int. Total
	Left	Thru	App. Total	Left	Right	App. Total	Thru	Right	App. Total	
04:00 PM	0	3	3	0	0	0	3	0	3	6
04:15 PM	0	0	0	0	0	0	0	0	0	0
04:30 PM	0	6	6	0	0	0	0	0	0	6
04:45 PM	0	4	4	0	0	0	0	0	0	4
Total	0	13	13	0	0	0	3	0	3	16
05:00 PM	0	3	3	0	0	0	1	0	1	4
05:15 PM	0	3	3	0	0	0	2	0	2	5
05:30 PM	0	0	0	0	0	0	0	0	0	0
05:45 PM	0	2	2	0	0	0	0	0	0	2
Total	0	8	8	0	0	0	3	0	3	11
Grand Total	0	21	21	0	0	0	6	0	6	27
Apprch %	0	100		0	0		100	0		
Total %	0	77.8	77.8	0	0	0	22.2	0	22.2	

Start Time	Harvill Avenue Southbound			Americas Tire Drive Westbound			Harvill Avenue Northbound			Int. Total
	Left	Thru	App. Total	Left	Right	App. Total	Thru	Right	App. Total	
04:00 PM	0	3	3	0	0	0	3	0	3	6
04:15 PM	0	0	0	0	0	0	0	0	0	0
04:30 PM	0	6	6	0	0	0	0	0	0	6
04:45 PM	0	4	4	0	0	0	0	0	0	4
Total Volume	0	13	13	0	0	0	3	0	3	16
% App. Total	0	100		0	0		100	0		
PHF	.000	.542	.542	.000	.000	.000	.250	.000	.250	.667

Peak Hour Analysis From 04:00 PM to 04:45 PM - Peak 1 of 1

Peak Hour for Entire Intersection Begins at 04:00 PM

County of Riverside  
 N/S: Harvill Avenue  
 E/W: Americas Tire Drive  
 Weather: Clear

File Name : 04\_CRV\_Har\_Am T PM  
 Site Code : 05122112  
 Start Date : 2/8/2022  
 Page No : 2

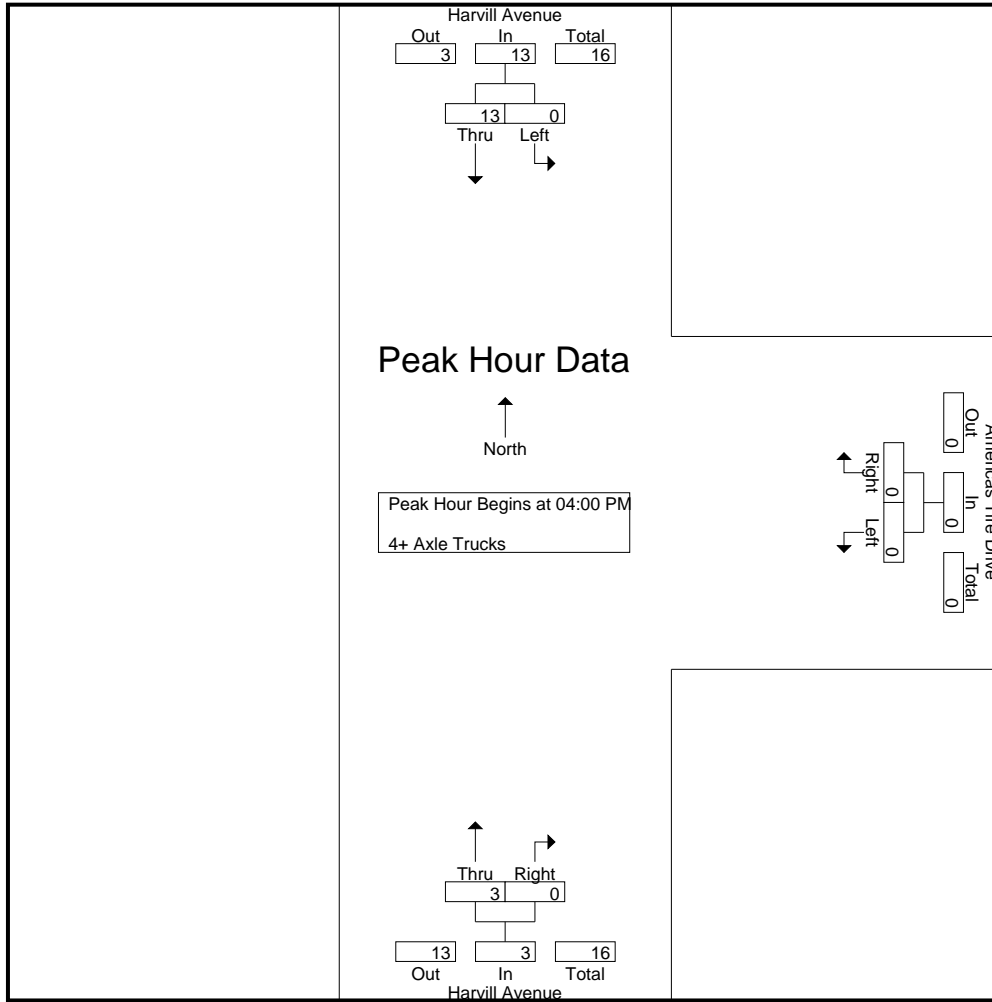

Peak Hour Analysis From 04:00 PM to 04:45 PM - Peak 1 of 1  
 Peak Hour for Each Approach Begins at:

	04:00 PM			04:00 PM			04:00 PM		
+0 mins.	0	3	3	0	0	0	<b>3</b>	0	<b>3</b>
+15 mins.	0	0	0	0	0	0	0	0	0
+30 mins.	0	<b>6</b>	<b>6</b>	0	0	0	0	0	0
+45 mins.	0	4	4	0	0	0	0	0	0
Total Volume	0	13	13	0	0	0	3	0	3
% App. Total	0	100		0	0		100	0	
PHF	.000	.542	.542	.000	.000	.000	.250	.000	.250

Location: County of Riverside  
 N/S: Harvill Avenue  
 E/W: Americas Tire Drive



Date: 2/8/2022  
 Day: Tuesday

PEDESTRIANS

	North Leg Harvill Avenue	East Leg Americas Tire Drive	South Leg Harvill Avenue	West Leg Dead End	
	Pedestrians	Pedestrians	Pedestrians	Pedestrians	
7:00 AM	0	0	0	0	0
7:15 AM	0	0	0	0	0
7:30 AM	0	0	0	0	0
7:45 AM	0	0	0	0	0
8:00 AM	0	0	0	0	0
8:15 AM	0	0	0	0	0
8:30 AM	0	0	0	0	0
8:45 AM	0	0	0	0	0
TOTAL VOLUMES:	0	0	0	0	0

	North Leg Harvill Avenue	East Leg Americas Tire Drive	South Leg Harvill Avenue	West Leg Dead End	
	Pedestrians	Pedestrians	Pedestrians	Pedestrians	
4:00 PM	0	0	0	0	0
4:15 PM	0	0	0	0	0
4:30 PM	0	0	0	0	0
4:45 PM	0	0	0	0	0
5:00 PM	0	0	0	0	0
5:15 PM	0	0	0	0	0
5:30 PM	0	0	0	0	0
5:45 PM	0	0	0	0	0
TOTAL VOLUMES:	0	0	0	0	0

Location: County of Riverside  
 N/S: Harvill Avenue  
 E/W: Americas Tire Drive



Date: 2/8/2022  
 Day: Tuesday

BICYCLES

	Southbound Harvill Avenue			Westbound Americas Tire Drive			Northbound Harvill Avenue			Eastbound Dead End			
	Left	Thru	Right	Left	Thru	Right	Left	Thru	Right	Left	Thru	Right	
7:00 AM	0	0	0	0	0	0	0	0	0	0	0	0	0
7:15 AM	0	0	0	0	0	0	0	0	0	0	0	0	0
7:30 AM	0	0	0	0	0	0	0	0	0	0	0	0	0
7:45 AM	0	0	0	0	0	0	0	0	0	0	0	0	0
8:00 AM	0	0	0	0	0	0	0	0	0	0	0	0	0
8:15 AM	0	0	0	0	0	0	0	0	0	0	0	0	0
8:30 AM	0	0	0	0	0	0	0	0	0	0	0	0	0
8:45 AM	0	0	0	0	0	0	0	0	0	0	0	0	0
TOTAL VOLUMES:	0	0	0	0	0	0	0	0	0	0	0	0	0

	Southbound Harvill Avenue			Westbound Americas Tire Drive			Northbound Harvill Avenue			Eastbound Dead End			
	Left	Thru	Right	Left	Thru	Right	Left	Thru	Right	Left	Thru	Right	
4:00 PM	0	0	0	0	0	0	0	0	0	0	0	0	0
4:15 PM	0	0	0	0	0	0	0	0	0	0	0	0	0
4:30 PM	0	0	0	0	0	0	0	0	0	0	0	0	0
4:45 PM	0	0	0	0	0	0	0	0	0	0	0	0	0
5:00 PM	0	0	0	0	0	0	0	0	0	0	0	0	0
5:15 PM	0	0	0	0	0	0	0	0	0	0	0	0	0
5:30 PM	0	0	0	0	0	0	0	1	0	0	0	0	1
5:45 PM	0	0	0	0	0	0	0	0	0	0	0	0	0
TOTAL VOLUMES:	0	0	0	0	0	0	0	1	0	0	0	0	1

County of Riverside  
 N/S: Harvill Avenue  
 E/W: Cajalco Expressway  
 Weather: Clear

File Name : 18\_CRV\_Har\_Caj AM  
 Site Code : 05122112  
 Start Date : 2/8/2022  
 Page No : 1

Groups Printed- Passenger Vehicles - Large 2 Axle Vehicles - 3 Axle Vehicles - 4+ Axle Trucks

Start Time	Harvill Avenue Southbound					Cajalco Expressway Westbound					Harvill Avenue Northbound					Cajalco Expressway Eastbound					Exclu. Total	Inclu. Total	Int. Total
	Left	Thru	Right	RTOR	App. Total	Left	Thru	Right	RTOR	App. Total	Left	Thru	Right	RTOR	App. Total	Left	Thru	Right	RTOR	App. Total			
07:00 AM	52	24	5	1	81	34	177	13	12	224	79	80	10	14	169	9	130	7	6	146	33	620	653
07:15 AM	41	23	6	0	70	28	154	16	13	198	91	68	18	15	177	6	149	11	10	166	38	611	649
07:30 AM	35	23	6	1	64	43	167	34	23	244	61	94	13	10	168	9	180	18	16	207	50	683	733
07:45 AM	46	32	2	0	80	30	130	31	15	191	54	86	24	11	164	13	167	12	15	192	41	627	668
Total	174	102	19	2	295	135	628	94	63	857	285	328	65	50	678	37	626	48	47	711	162	2541	2703
08:00 AM	42	30	2	0	74	31	154	28	11	213	54	61	17	15	132	8	133	19	5	160	31	579	610
08:15 AM	56	31	3	4	90	25	132	18	24	175	31	32	5	16	68	9	130	13	11	152	55	485	540
08:30 AM	40	27	0	0	67	29	124	17	10	170	29	29	2	20	60	5	134	14	12	153	42	450	492
08:45 AM	31	17	7	3	55	29	175	21	7	225	27	21	2	13	50	5	131	20	7	156	30	486	516
Total	169	105	12	7	286	114	585	84	52	783	141	143	26	64	310	27	528	66	35	621	158	2000	2158
Grand Total	343	207	31	9	581	249	1213	178	115	1640	426	471	91	114	988	64	1154	114	82	1332	320	4541	4861
Apprch %	59	35.6	5.3			15.2	74	10.9			43.1	47.7	9.2			4.8	86.6	8.6					
Total %	7.6	4.6	0.7		12.8	5.5	26.7	3.9		36.1	9.4	10.4	2		21.8	1.4	25.4	2.5		29.3	6.6	93.4	
Passenger Vehicles	314	187	19		525	191	1118	161		1579	407	460	75		1036	51	1064	107		1301	0	0	4441
% Passenger Vehicles	91.5	90.3	61.3	55.6	89	76.7	92.2	90.4	94.8	90	95.5	97.7	82.4	82.5	94	79.7	92.2	93.9	96.3	92	0	0	91.4
Large 2 Axle Vehicles	17	10	5		33	23	47	12		85	13	3	6		30	3	41	0		46	0	0	194
% Large 2 Axle Vehicles	5	4.8	16.1	11.1	5.6	9.2	3.9	6.7	2.6	4.8	3.1	0.6	6.6	7	2.7	4.7	3.6	0	2.4	3.3	0	0	4
3 Axle Vehicles	3	1	0		5	5	9	1		17	2	3	1		8	3	10	1		14	0	0	44
% 3 Axle Vehicles	0.9	0.5	0	11.1	0.8	2	0.7	0.6	1.7	1	0.5	0.6	1.1	1.8	0.7	4.7	0.9	0.9	0	1	0	0	0.9
4+ Axle Trucks	9	9	7		27	30	39	4		74	4	5	9		28	7	39	6		53	0	0	182
% 4+ Axle Trucks	2.6	4.3	22.6	22.2	4.6	12	3.2	2.2	0.9	4.2	0.9	1.1	9.9	8.8	2.5	10.9	3.4	5.3	1.2	3.7	0	0	3.7

Start Time	Harvill Avenue Southbound				Cajalco Expressway Westbound				Harvill Avenue Northbound				Cajalco Expressway Eastbound				Int. Total
	Left	Thru	Right	App. Total	Left	Thru	Right	App. Total	Left	Thru	Right	App. Total	Left	Thru	Right	App. Total	
Peak Hour Analysis From 07:00 AM to 08:45 AM - Peak 1 of 1																	
Peak Hour for Entire Intersection Begins at 07:00 AM																	
07:00 AM	52	24	5	81	34	177	13	224	79	80	10	169	9	130	7	146	620
07:15 AM	41	23	6	70	28	154	16	198	91	68	18	177	6	149	11	166	611
07:30 AM	35	23	6	64	43	167	34	244	61	94	13	168	9	180	18	207	683
07:45 AM	46	32	2	80	30	130	31	191	54	86	24	164	13	167	12	192	627
Total Volume	174	102	19	295	135	628	94	857	285	328	65	678	37	626	48	711	2541
% App. Total	59	34.6	6.4		15.8	73.3	11		42	48.4	9.6		5.2	88	6.8		
PHF	.837	.797	.792	.910	.785	.887	.691	.878	.783	.872	.677	.958	.712	.869	.667	.859	.930

County of Riverside  
 N/S: Harvill Avenue  
 E/W: Cajalco Expressway  
 Weather: Clear

File Name : 18\_CRV\_Har\_Caj AM  
 Site Code : 05122112  
 Start Date : 2/8/2022  
 Page No : 2

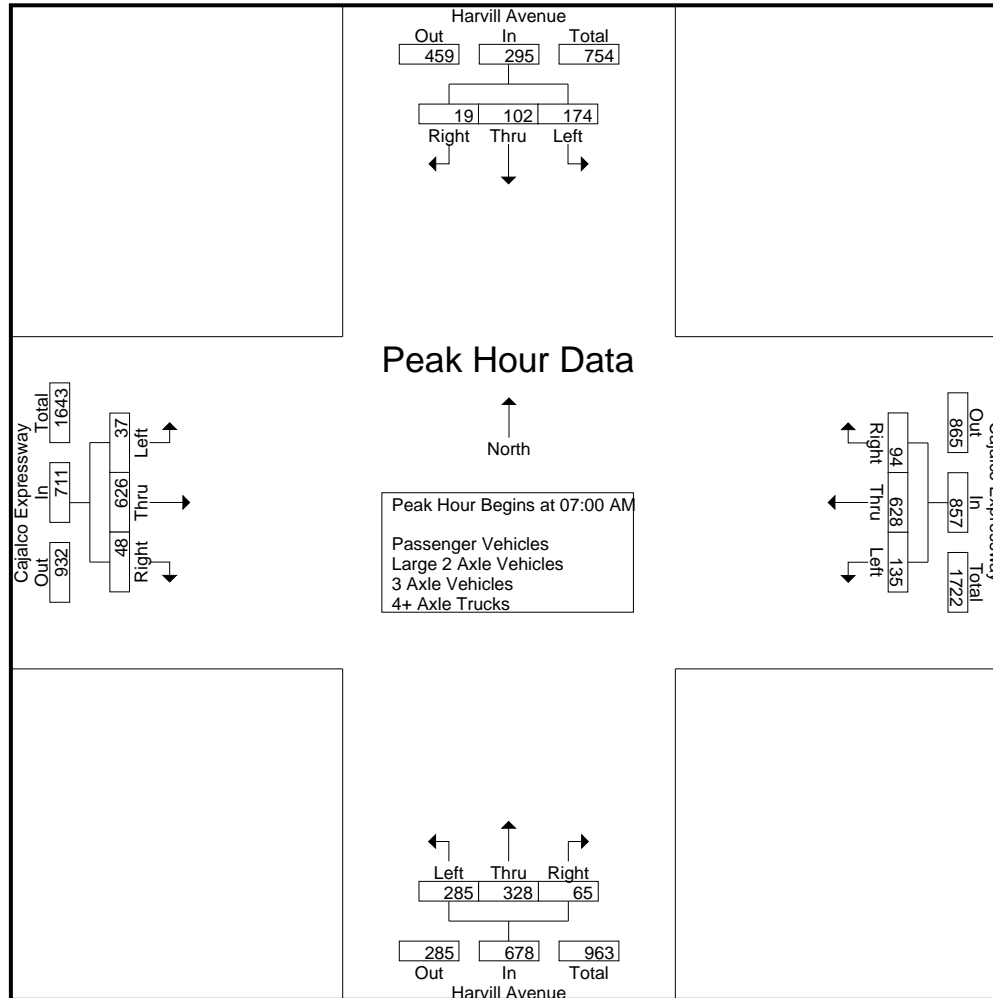

County of Riverside  
 N/S: Harvill Avenue  
 E/W: Cajalco Expressway  
 Weather: Clear

File Name : 18\_CRV\_Har\_Caj AM  
 Site Code : 05122112  
 Start Date : 2/8/2022  
 Page No : 3

Start Time	Harvill Avenue Southbound				Cajalco Expressway Westbound				Harvill Avenue Northbound				Cajalco Expressway Eastbound				Int. Total
	Left	Thru	Right	App. Total	Left	Thru	Right	App. Total	Left	Thru	Right	App. Total	Left	Thru	Right	App. Total	
Peak Hour Analysis From 07:00 AM to 08:45 AM - Peak 1 of 1																	
Peak Hour for Each Approach Begins at:																	
	07:45 AM				07:00 AM				07:00 AM				07:15 AM				
+0 mins.	46	<b>32</b>	2	80	34	<b>177</b>	13	224	79	80	10	169	6	149	11	166	
+15 mins.	42	30	2	74	28	154	16	198	<b>91</b>	68	18	<b>177</b>	9	<b>180</b>	18	<b>207</b>	
+30 mins.	<b>56</b>	31	<b>3</b>	<b>90</b>	<b>43</b>	167	<b>34</b>	<b>244</b>	61	<b>94</b>	13	168	<b>13</b>	167	12	192	
+45 mins.	40	27	0	67	30	130	31	191	54	86	<b>24</b>	164	8	133	<b>19</b>	160	
Total Volume	184	120	7	311	135	628	94	857	285	328	65	678	36	629	60	725	
% App. Total	59.2	38.6	2.3		15.8	73.3	11		42	48.4	9.6		5	86.8	8.3		
PHF	.821	.938	.583	.864	.785	.887	.691	.878	.783	.872	.677	.958	.692	.874	.789	.876	

County of Riverside  
 N/S: Harvill Avenue  
 E/W: Cajalco Expressway  
 Weather: Clear

File Name : 18\_CRV\_Har\_Caj AM  
 Site Code : 05122112  
 Start Date : 2/8/2022  
 Page No : 1

Groups Printed- Large 2 Axle Vehicles

Start Time	Harvill Avenue Southbound					Cajalco Expressway Westbound					Harvill Avenue Northbound					Cajalco Expressway Eastbound					Exclu. Total	Inclu. Total	Int. Total
	Left	Thru	Right	RTOR	App. Total	Left	Thru	Right	RTOR	App. Total	Left	Thru	Right	RTOR	App. Total	Left	Thru	Right	RTOR	App. Total			
07:00 AM	3	0	1	0	4	4	6	2	1	12	5	1	3	2	9	0	2	0	0	2	3	27	30
07:15 AM	2	0	0	0	2	3	5	1	0	9	4	0	1	0	5	0	5	0	1	5	1	21	22
07:30 AM	0	2	1	1	3	1	10	1	0	12	0	0	1	0	1	1	7	0	0	8	1	24	25
07:45 AM	3	1	1	0	5	3	8	0	0	11	1	0	1	1	2	2	5	0	0	7	1	25	26
Total	8	3	3	1	14	11	29	4	1	44	10	1	6	3	17	3	19	0	1	22	6	97	103
08:00 AM	4	2	0	0	6	1	5	3	0	9	0	1	0	1	1	0	6	0	0	6	1	22	23
08:15 AM	0	3	0	0	3	3	3	2	1	8	1	1	0	1	2	0	8	0	0	8	2	21	23
08:30 AM	4	2	0	0	6	3	5	0	0	8	1	0	0	1	1	0	3	0	1	3	2	18	20
08:45 AM	1	0	2	0	3	5	5	3	1	13	1	0	0	2	1	0	5	0	0	5	3	22	25
Total	9	7	2	0	18	12	18	8	2	38	3	2	0	5	5	0	22	0	1	22	8	83	91
Grand Total	17	10	5	1	32	23	47	12	3	82	13	3	6	8	22	3	41	0	2	44	14	180	194
Apprch %	53.1	31.2	15.6			28	57.3	14.6			59.1	13.6	27.3			6.8	93.2	0					
Total %	9.4	5.6	2.8		17.8	12.8	26.1	6.7		45.6	7.2	1.7	3.3		12.2	1.7	22.8	0		24.4	7.2	92.8	

Start Time	Harvill Avenue Southbound				Cajalco Expressway Westbound				Harvill Avenue Northbound				Cajalco Expressway Eastbound				Int. Total
	Left	Thru	Right	App. Total	Left	Thru	Right	App. Total	Left	Thru	Right	App. Total	Left	Thru	Right	App. Total	
Peak Hour Analysis From 07:00 AM to 07:45 AM - Peak 1 of 1																	
Peak Hour for Entire Intersection Begins at 07:00 AM																	
07:00 AM	3	0	1	4	4	6	2	12	5	1	3	9	0	2	0	2	27
07:15 AM	2	0	0	2	3	5	1	9	4	0	1	5	0	5	0	5	21
07:30 AM	0	2	1	3	1	10	1	12	0	0	1	1	1	7	0	8	24
07:45 AM	3	1	1	5	3	8	0	11	1	0	1	2	2	5	0	7	25
Total Volume	8	3	3	14	11	29	4	44	10	1	6	17	3	19	0	22	97
% App. Total	57.1	21.4	21.4		25	65.9	9.1		58.8	5.9	35.3		13.6	86.4	0		
PHF	.667	.375	.750	.700	.688	.725	.500	.917	.500	.250	.500	.472	.375	.679	.000	.688	.898



County of Riverside  
 N/S: Harvill Avenue  
 E/W: Cajalco Expressway  
 Weather: Clear

File Name : 18\_CRV\_Har\_Caj AM  
 Site Code : 05122112  
 Start Date : 2/8/2022  
 Page No : 2

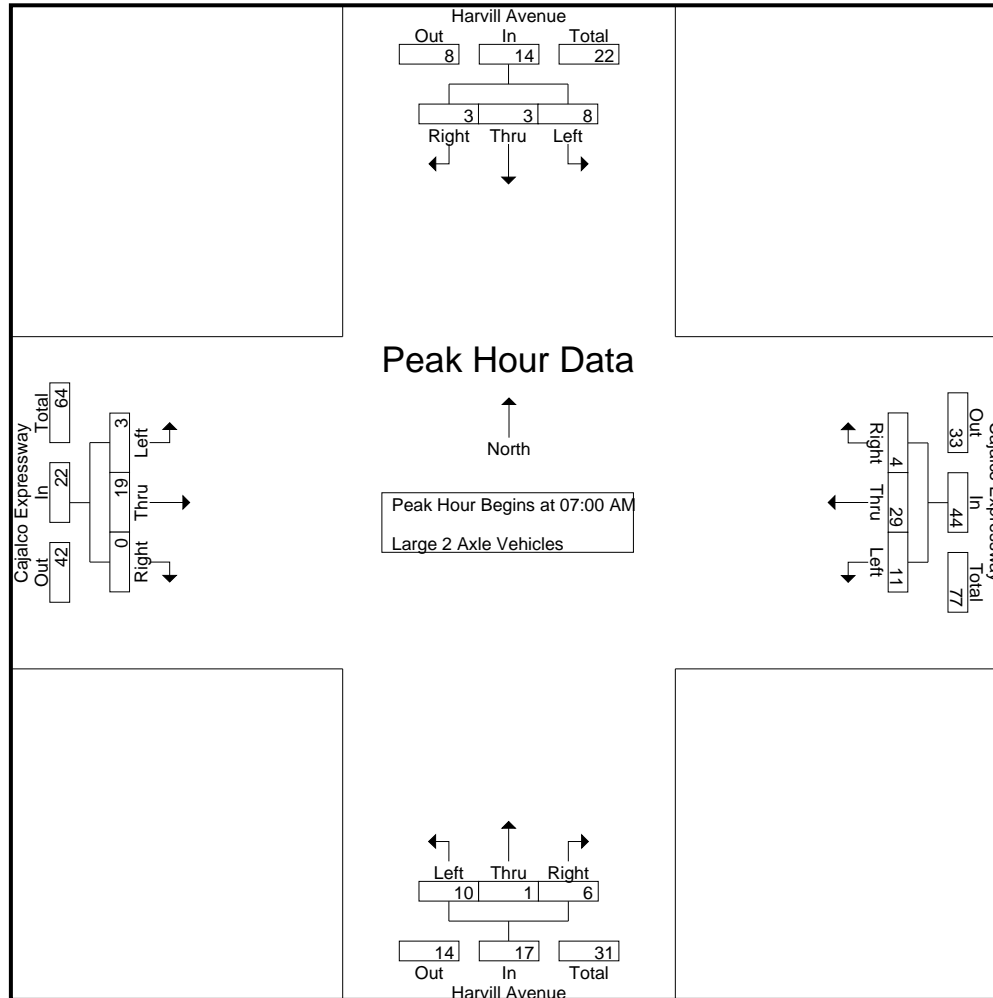

County of Riverside  
 N/S: Harvill Avenue  
 E/W: Cajalco Expressway  
 Weather: Clear

File Name : 18\_CRV\_Har\_Caj AM  
 Site Code : 05122112  
 Start Date : 2/8/2022  
 Page No : 3

Start Time	Harvill Avenue Southbound				Cajalco Expressway Westbound				Harvill Avenue Northbound				Cajalco Expressway Eastbound				Int. Total
	Left	Thru	Right	App. Total	Left	Thru	Right	App. Total	Left	Thru	Right	App. Total	Left	Thru	Right	App. Total	
Peak Hour Analysis From 07:00 AM to 07:45 AM - Peak 1 of 1																	
Peak Hour for Each Approach Begins at:																	
	07:00 AM				07:00 AM				07:00 AM				07:00 AM				
+0 mins.	3	0	1	4	4	6	2	12	5	1	3	9	0	2	0	2	
+15 mins.	2	0	0	2	3	5	1	9	4	0	1	5	0	5	0	5	
+30 mins.	0	2	1	3	1	10	1	12	0	0	1	1	1	7	0	8	
+45 mins.	3	1	1	5	3	8	0	11	1	0	1	2	2	5	0	7	
Total Volume	8	3	3	14	11	29	4	44	10	1	6	17	3	19	0	22	
% App. Total	57.1	21.4	21.4		25	65.9	9.1		58.8	5.9	35.3		13.6	86.4	0		
PHF	.667	.375	.750	.700	.688	.725	.500	.917	.500	.250	.500	.472	.375	.679	.000	.688	

County of Riverside  
 N/S: Harvill Avenue  
 E/W: Cajalco Expressway  
 Weather: Clear

File Name : 18\_CRV\_Har\_Caj AM  
 Site Code : 05122112  
 Start Date : 2/8/2022  
 Page No : 1

Groups Printed- 3 Axle Vehicles

Start Time	Harvill Avenue Southbound					Cajalco Expressway Westbound					Harvill Avenue Northbound					Cajalco Expressway Eastbound					Exclu. Total	Inclu. Total	Int. Total	
	Left	Thru	Right	RTOR	App. Total	Left	Thru	Right	RTOR	App. Total	Left	Thru	Right	RTOR	App. Total	Left	Thru	Right	RTOR	App. Total				
07:00 AM	0	0	0	0	0	0	0	0	1	0	0	0	0	1	0	0	0	0	0	0	0	2	0	2
07:15 AM	1	0	0	0	1	1	2	0	0	3	0	1	0	0	1	1	0	0	0	1	0	6	0	6
07:30 AM	0	0	0	0	0	1	1	0	0	2	0	0	1	1	1	1	2	0	0	3	1	6	0	7
07:45 AM	0	0	0	0	0	0	1	0	0	1	1	1	0	0	2	0	2	0	0	2	0	5	0	5
Total	1	0	0	0	1	2	4	0	1	6	1	2	1	2	4	2	4	0	0	6	3	17	0	20
08:00 AM	1	1	0	0	2	0	2	0	0	2	0	1	0	0	1	0	2	0	0	2	0	7	0	7
08:15 AM	0	0	0	0	0	1	1	0	0	2	0	0	0	0	0	0	1	0	0	1	0	3	0	3
08:30 AM	1	0	0	0	1	0	2	0	1	2	0	0	0	0	0	1	1	0	0	2	1	5	0	6
08:45 AM	0	0	0	1	0	2	0	1	0	3	1	0	0	0	1	0	2	1	0	3	1	7	0	8
Total	2	1	0	1	3	3	5	1	1	9	1	1	0	0	2	1	6	1	0	8	2	22	0	24
Grand Total	3	1	0	1	4	5	9	1	2	15	2	3	1	2	6	3	10	1	0	14	5	39	0	44
Apprch %	75	25	0			33.3	60	6.7			33.3	50	16.7			21.4	71.4	7.1						
Total %	7.7	2.6	0		10.3	12.8	23.1	2.6		38.5	5.1	7.7	2.6		15.4	7.7	25.6	2.6		35.9	11.4	88.6		

Start Time	Harvill Avenue Southbound				Cajalco Expressway Westbound				Harvill Avenue Northbound				Cajalco Expressway Eastbound				Int. Total
	Left	Thru	Right	App. Total	Left	Thru	Right	App. Total	Left	Thru	Right	App. Total	Left	Thru	Right	App. Total	
Peak Hour Analysis From 07:00 AM to 07:45 AM - Peak 1 of 1																	
Peak Hour for Entire Intersection Begins at 07:00 AM																	
07:00 AM	0	0	0	0	0	0	0	0	0	0	0	0	0	0	0	0	0
07:15 AM	1	0	0	1	1	2	0	3	0	1	0	1	1	0	0	1	6
07:30 AM	0	0	0	0	1	1	0	2	0	0	1	1	1	2	0	3	6
07:45 AM	0	0	0	0	0	1	0	1	1	1	0	2	0	2	0	2	5
Total Volume	1	0	0	1	2	4	0	6	1	2	1	4	2	4	0	6	17
% App. Total	100	0	0		33.3	66.7	0		25	50	25		33.3	66.7	0		
PHF	.250	.000	.000	.250	.500	.500	.000	.500	.250	.500	.250	.500	.500	.500	.000	.500	.708

County of Riverside  
 N/S: Harvill Avenue  
 E/W: Cajalco Expressway  
 Weather: Clear

File Name : 18\_CRV\_Har\_Caj AM  
 Site Code : 05122112  
 Start Date : 2/8/2022  
 Page No : 2

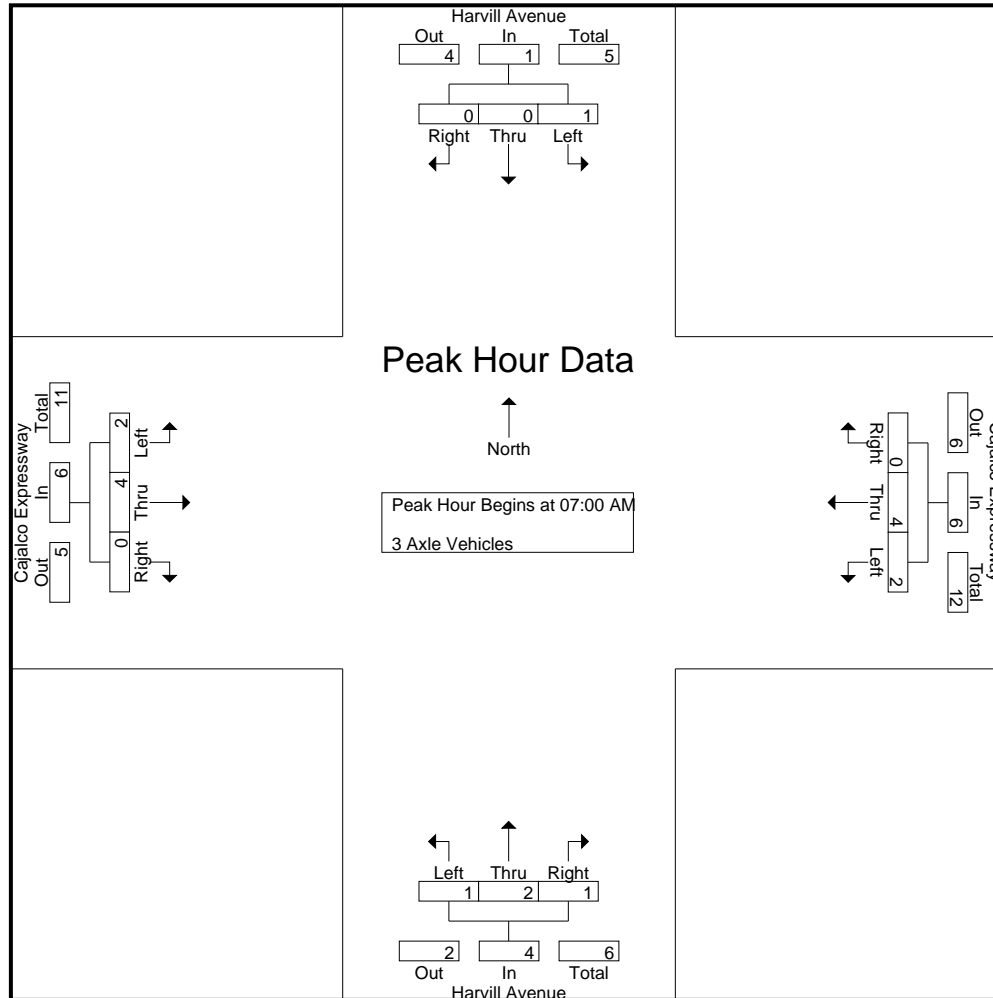

County of Riverside  
 N/S: Harvill Avenue  
 E/W: Cajalco Expressway  
 Weather: Clear

File Name : 18\_CRV\_Har\_Caj AM  
 Site Code : 05122112  
 Start Date : 2/8/2022  
 Page No : 3

Start Time	Harvill Avenue Southbound				Cajalco Expressway Westbound				Harvill Avenue Northbound				Cajalco Expressway Eastbound				Int. Total
	Left	Thru	Right	App. Total	Left	Thru	Right	App. Total	Left	Thru	Right	App. Total	Left	Thru	Right	App. Total	
Peak Hour Analysis From 07:00 AM to 07:45 AM - Peak 1 of 1																	
Peak Hour for Each Approach Begins at:																	
	07:00 AM				07:00 AM				07:00 AM				07:00 AM				
+0 mins.	0	0	0	0	0	0	0	0	0	0	0	0	0	0	0	0	
+15 mins.	1	0	0	1	1	2	0	3	0	1	0	1	1	0	0	1	
+30 mins.	0	0	0	0	1	1	0	2	0	0	1	1	1	2	0	3	
+45 mins.	0	0	0	0	0	1	0	1	1	1	0	2	0	2	0	2	
Total Volume	1	0	0	1	2	4	0	6	1	2	1	4	2	4	0	6	
% App. Total	100	0	0		33.3	66.7	0		25	50	25		33.3	66.7	0		
PHF	.250	.000	.000	.250	.500	.500	.000	.500	.250	.500	.250	.500	.500	.500	.000	.500	

County of Riverside  
 N/S: Harvill Avenue  
 E/W: Cajalco Expressway  
 Weather: Clear

File Name : 18\_CRV\_Har\_Caj AM  
 Site Code : 05122112  
 Start Date : 2/8/2022  
 Page No : 1

Groups Printed- 4+ Axle Trucks

Start Time	Harvill Avenue Southbound					Cajalco Expressway Westbound					Harvill Avenue Northbound					Cajalco Expressway Eastbound					Exclu. Total	Inclu. Total	Int. Total
	Left	Thru	Right	RTOR	App. Total	Left	Thru	Right	RTOR	App. Total	Left	Thru	Right	RTOR	App. Total	Left	Thru	Right	RTOR	App. Total			
07:00 AM	2	2	2	0	6	4	5	1	0	10	1	0	1	1	2	1	7	0	0	8	1	26	27
07:15 AM	2	2	0	0	4	3	1	0	0	4	1	2	1	1	4	0	4	0	0	4	1	16	17
07:30 AM	1	0	1	0	2	3	4	1	0	8	0	1	0	1	1	0	4	0	0	4	1	15	16
07:45 AM	0	2	0	0	2	2	5	1	0	8	1	0	1	2	2	2	5	1	1	8	3	20	23
Total	5	6	3	0	14	12	15	3	0	30	3	3	3	5	9	3	20	1	1	24	6	77	83
08:00 AM	1	1	1	0	3	4	7	1	0	12	0	1	3	0	4	0	5	3	0	8	0	27	27
08:15 AM	2	0	2	1	4	4	3	0	1	7	0	0	1	1	1	3	5	1	0	9	3	21	24
08:30 AM	1	0	0	0	1	5	5	0	0	10	0	0	2	1	2	1	6	0	0	7	1	20	21
08:45 AM	0	2	1	1	3	5	9	0	0	14	1	1	0	3	2	0	3	1	0	4	4	23	27
Total	4	3	4	2	11	18	24	1	1	43	1	2	6	5	9	4	19	5	0	28	8	91	99
Grand Total	9	9	7	2	25	30	39	4	1	73	4	5	9	10	18	7	39	6	1	52	14	168	182
Apprch %	36	36	28			41.1	53.4	5.5			22.2	27.8	50			13.5	75	11.5					
Total %	5.4	5.4	4.2		14.9	17.9	23.2	2.4		43.5	2.4	3	5.4		10.7	4.2	23.2	3.6		31	7.7	92.3	

Start Time	Harvill Avenue Southbound				Cajalco Expressway Westbound				Harvill Avenue Northbound				Cajalco Expressway Eastbound				Int. Total
	Left	Thru	Right	App. Total	Left	Thru	Right	App. Total	Left	Thru	Right	App. Total	Left	Thru	Right	App. Total	
Peak Hour Analysis From 07:00 AM to 07:45 AM - Peak 1 of 1																	
Peak Hour for Entire Intersection Begins at 07:00 AM																	
07:00 AM	2	2	2	6	4	5	1	10	1	0	1	2	1	7	0	8	26
07:15 AM	2	2	0	4	3	1	0	4	1	2	1	4	0	4	0	4	16
07:30 AM	1	0	1	2	3	4	1	8	0	1	0	1	0	4	0	4	15
07:45 AM	0	2	0	2	2	5	1	8	1	0	1	2	2	5	1	8	20
Total Volume	5	6	3	14	12	15	3	30	3	3	3	9	3	20	1	24	77
% App. Total	35.7	42.9	21.4		40	50	10		33.3	33.3	33.3		12.5	83.3	4.2		
PHF	.625	.750	.375	.583	.750	.750	.750	.750	.750	.375	.750	.563	.375	.714	.250	.750	.740

County of Riverside  
 N/S: Harvill Avenue  
 E/W: Cajalco Expressway  
 Weather: Clear

File Name : 18\_CRV\_Har\_Caj AM  
 Site Code : 05122112  
 Start Date : 2/8/2022  
 Page No : 2

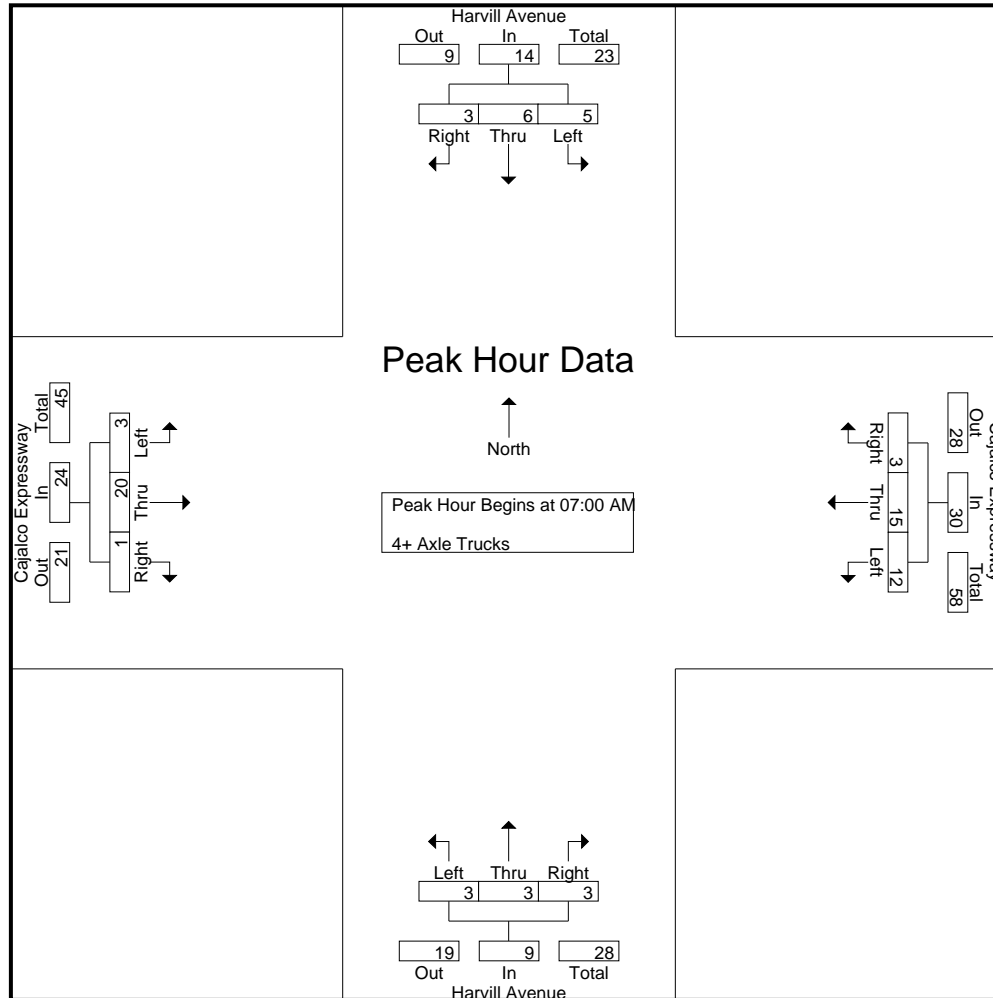

County of Riverside  
 N/S: Harvill Avenue  
 E/W: Cajalco Expressway  
 Weather: Clear

File Name : 18\_CRV\_Har\_Caj AM  
 Site Code : 05122112  
 Start Date : 2/8/2022  
 Page No : 3

Start Time	Harvill Avenue Southbound				Cajalco Expressway Westbound				Harvill Avenue Northbound				Cajalco Expressway Eastbound				Int. Total
	Left	Thru	Right	App. Total	Left	Thru	Right	App. Total	Left	Thru	Right	App. Total	Left	Thru	Right	App. Total	
Peak Hour Analysis From 07:00 AM to 07:45 AM - Peak 1 of 1																	
Peak Hour for Each Approach Begins at:																	
	07:00 AM				07:00 AM				07:00 AM				07:00 AM				
+0 mins.	2	2	2	6	4	5	1	10	1	0	1	2	1	7	0	8	
+15 mins.	2	2	0	4	3	1	0	4	1	2	1	4	0	4	0	4	
+30 mins.	1	0	1	2	3	4	1	8	0	1	0	1	0	4	0	4	
+45 mins.	0	2	0	2	2	5	1	8	1	0	1	2	2	5	1	8	
Total Volume	5	6	3	14	12	15	3	30	3	3	3	9	3	20	1	24	
% App. Total	35.7	42.9	21.4		40	50	10		33.3	33.3	33.3		12.5	83.3	4.2		
PHF	.625	.750	.375	.583	.750	.750	.750	.750	.750	.375	.750	.563	.375	.714	.250	.750	



County of Riverside  
 N/S: Harvill Avenue  
 E/W: Cajalco Expressway  
 Weather: Clear

File Name : 18\_CRV\_Har\_Caj PM  
 Site Code : 05122112  
 Start Date : 2/8/2022  
 Page No : 1

Groups Printed- Passenger Vehicles - Large 2 Axle Vehicles - 3 Axle Vehicles - 4+ Axle Trucks

Start Time	Harvill Avenue Southbound					Cajalco Expressway Westbound					Harvill Avenue Northbound					Cajalco Expressway Eastbound					Exclu. Total	Inclu. Total	Int. Total
	Left	Thru	Right	RTOR	App. Total	Left	Thru	Right	RTOR	App. Total	Left	Thru	Right	RTOR	App. Total	Left	Thru	Right	RTOR	App. Total			
04:00 PM	42	48	14	7	104	31	173	64	31	268	50	40	30	11	120	5	147	64	29	216	78	708	786
04:15 PM	46	46	5	2	97	23	139	33	7	195	33	33	25	15	91	11	158	44	29	213	53	596	649
04:30 PM	77	51	8	0	136	25	151	42	22	218	38	39	25	11	102	4	196	52	26	252	59	708	767
04:45 PM	53	55	5	1	113	22	134	35	14	191	38	28	36	26	102	2	185	40	21	227	62	633	695
Total	218	200	32	10	450	101	597	174	74	872	159	140	116	63	415	22	686	200	105	908	252	2645	2897
05:00 PM	60	42	6	2	108	21	150	45	19	216	39	22	26	14	87	7	189	30	20	226	55	637	692
05:15 PM	68	44	7	2	119	22	174	47	20	243	33	27	24	16	84	7	166	41	20	214	58	660	718
05:30 PM	43	49	4	0	96	20	166	40	17	226	41	29	19	14	89	4	229	33	12	266	43	677	720
05:45 PM	63	35	6	1	104	27	157	35	16	219	46	21	26	17	93	2	209	32	8	243	42	659	701
Total	234	170	23	5	427	90	647	167	72	904	159	99	95	61	353	20	793	136	60	949	198	2633	2831
Grand Total	452	370	55	15	877	191	1244	341	146	1776	318	239	211	124	768	42	1479	336	165	1857	450	5278	5728
Apprch %	51.5	42.2	6.3			10.8	70	19.2			41.4	31.1	27.5			2.3	79.6	18.1					
Total %	8.6	7	1		16.6	3.6	23.6	6.5		33.6	6	4.5	4		14.6	0.8	28	6.4		35.2	7.9	92.1	
Passenger Vehicles	443	354	50		861	148	1190	322		1799	311	230	201		859	37	1426	320		1942	0	0	5461
% Passenger Vehicles	98	95.7	90.9	93.3	96.5	77.5	95.7	94.4	95.2	93.6	97.8	96.2	95.3	94.4	96.3	88.1	96.4	95.2	96.4	96	0	0	95.3
Large 2 Axle Vehicles	4	5	2		11	7	19	15		47	2	2	2		8	0	26	9		40	0	0	106
% Large 2 Axle Vehicles	0.9	1.4	3.6	0	1.2	3.7	1.5	4.4	4.1	2.4	0.6	0.8	0.9	1.6	0.9	0	1.8	2.7	3	2	0	0	1.9
3 Axle Vehicles	2	2	0		4	5	9	0		14	2	5	2		11	1	5	1		7	0	0	36
% 3 Axle Vehicles	0.4	0.5	0	0	0.4	2.6	0.7	0	0	0.7	0.6	2.1	0.9	1.6	1.2	2.4	0.3	0.3	0	0.3	0	0	0.6
4+ Axle Trucks	3	9	3		16	31	26	4		62	3	2	6		14	4	22	6		33	0	0	125
% 4+ Axle Trucks	0.7	2.4	5.5	6.7	1.8	16.2	2.1	1.2	0.7	3.2	0.9	0.8	2.8	2.4	1.6	9.5	1.5	1.8	0.6	1.6	0	0	2.2

Start Time	Harvill Avenue Southbound				Cajalco Expressway Westbound				Harvill Avenue Northbound				Cajalco Expressway Eastbound				Int. Total
	Left	Thru	Right	App. Total	Left	Thru	Right	App. Total	Left	Thru	Right	App. Total	Left	Thru	Right	App. Total	
Peak Hour Analysis From 04:00 PM to 05:45 PM - Peak 1 of 1																	
Peak Hour for Entire Intersection Begins at 04:00 PM																	
04:00 PM	42	48	14	104	31	173	64	268	50	40	30	120	5	147	64	216	708
04:15 PM	46	46	5	97	23	139	33	195	33	33	25	91	11	158	44	213	596
04:30 PM	77	51	8	136	25	151	42	218	38	39	25	102	4	196	52	252	708
04:45 PM	53	55	5	113	22	134	35	191	38	28	36	102	2	185	40	227	633
Total Volume	218	200	32	450	101	597	174	872	159	140	116	415	22	686	200	908	2645
% App. Total	48.4	44.4	7.1		11.6	68.5	20		38.3	33.7	28		2.4	75.6	22		
PHF	.708	.909	.571	.827	.815	.863	.680	.813	.795	.875	.806	.865	.500	.875	.781	.901	.934

County of Riverside  
 N/S: Harvill Avenue  
 E/W: Cajalco Expressway  
 Weather: Clear

File Name : 18\_CRV\_Har\_Caj PM  
 Site Code : 05122112  
 Start Date : 2/8/2022  
 Page No : 2

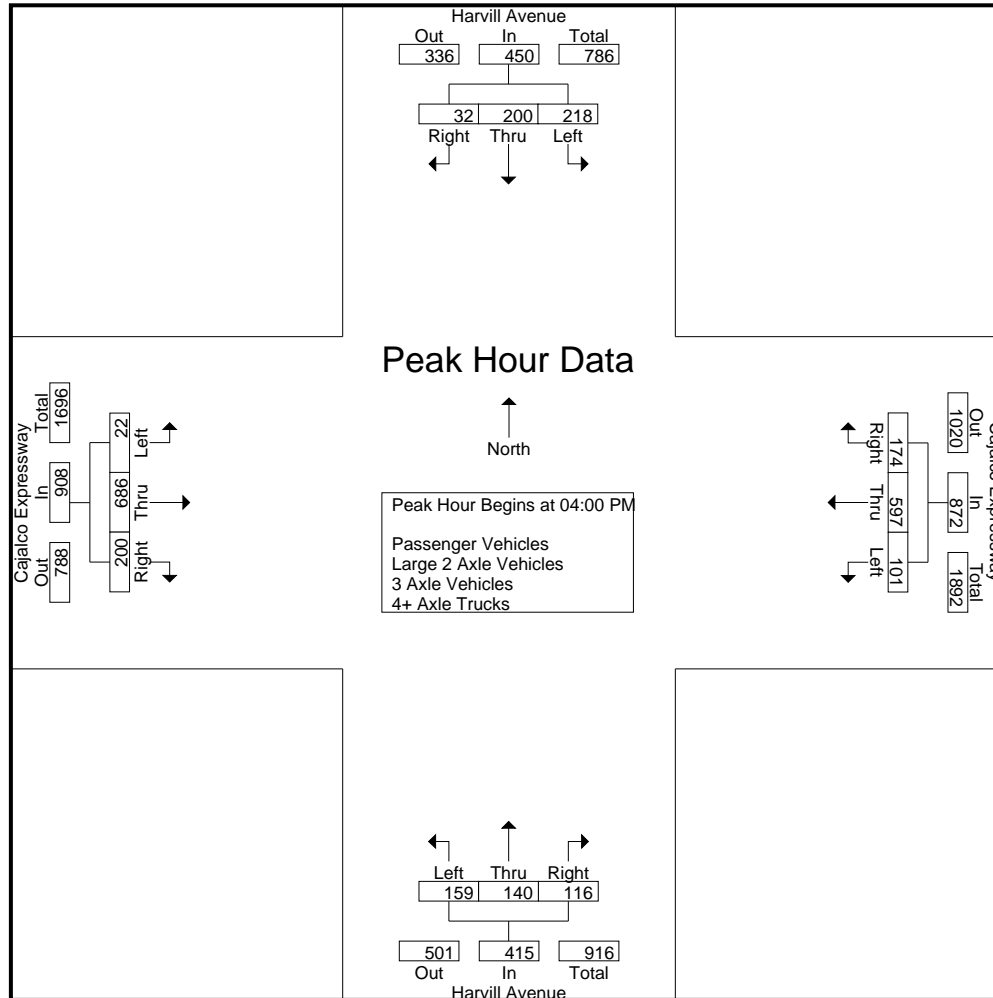

County of Riverside  
 N/S: Harvill Avenue  
 E/W: Cajalco Expressway  
 Weather: Clear

File Name : 18\_CRV\_Har\_Caj PM  
 Site Code : 05122112  
 Start Date : 2/8/2022  
 Page No : 3

Start Time	Harvill Avenue Southbound				Cajalco Expressway Westbound				Harvill Avenue Northbound				Cajalco Expressway Eastbound				Int. Total
	Left	Thru	Right	App. Total	Left	Thru	Right	App. Total	Left	Thru	Right	App. Total	Left	Thru	Right	App. Total	
Peak Hour Analysis From 04:00 PM to 05:45 PM - Peak 1 of 1																	
Peak Hour for Each Approach Begins at:																	
	04:30 PM				05:00 PM				04:00 PM				05:00 PM				
+0 mins.	<b>77</b>	51	<b>8</b>	<b>136</b>	21	150	45	216	<b>50</b>	<b>40</b>	30	<b>120</b>	<b>7</b>	189	30	226	
+15 mins.	53	<b>55</b>	5	113	22	<b>174</b>	<b>47</b>	<b>243</b>	33	33	25	91	7	166	<b>41</b>	214	
+30 mins.	60	42	6	108	20	166	40	226	38	39	25	102	4	<b>229</b>	33	<b>266</b>	
+45 mins.	68	44	7	119	<b>27</b>	157	35	219	38	28	<b>36</b>	102	2	209	32	243	
Total Volume	258	192	26	476	90	647	167	904	159	140	116	415	20	793	136	949	
% App. Total	54.2	40.3	5.5		10	71.6	18.5		38.3	33.7	28		2.1	83.6	14.3		
PHF	.838	.873	.813	.875	.833	.930	.888	.930	.795	.875	.806	.865	.714	.866	.829	.892	

County of Riverside  
 N/S: Harvill Avenue  
 E/W: Cajalco Expressway  
 Weather: Clear

File Name : 18\_CRV\_Har\_Caj PM  
 Site Code : 05122112  
 Start Date : 2/8/2022  
 Page No : 1

Groups Printed- Large 2 Axle Vehicles

Start Time	Harvill Avenue Southbound					Cajalco Expressway Westbound					Harvill Avenue Northbound					Cajalco Expressway Eastbound					Exclu. Total	Inclu. Total	Int. Total
	Left	Thru	Right	RTOR	App. Total	Left	Thru	Right	RTOR	App. Total	Left	Thru	Right	RTOR	App. Total	Left	Thru	Right	RTOR	App. Total			
04:00 PM	1	0	1	0	2	1	7	3	2	11	0	0	1	1	1	0	5	3	1	8	4	22	26
04:15 PM	0	0	0	0	0	1	3	2	0	6	1	0	0	0	1	0	2	1	1	3	1	10	11
04:30 PM	1	1	0	0	2	0	3	4	2	7	0	0	0	0	0	0	3	1	0	4	2	13	15
04:45 PM	0	1	1	0	2	0	1	3	0	4	0	0	0	0	0	0	4	1	1	5	1	11	12
Total	2	2	2	0	6	2	14	12	4	28	1	0	1	1	2	0	14	6	3	20	8	56	64
05:00 PM	1	0	0	0	1	2	2	0	0	4	0	1	0	0	1	0	1	1	1	2	1	8	9
05:15 PM	1	0	0	0	1	2	0	3	2	5	0	1	1	1	2	0	1	0	0	1	3	9	12
05:30 PM	0	2	0	0	2	1	3	0	0	4	0	0	0	0	0	0	7	2	1	9	1	15	16
05:45 PM	0	1	0	0	1	0	0	0	0	0	1	0	0	0	1	0	3	0	0	3	0	5	5
Total	2	3	0	0	5	5	5	3	2	13	1	2	1	1	4	0	12	3	2	15	5	37	42
Grand Total	4	5	2	0	11	7	19	15	6	41	2	2	2	2	6	0	26	9	5	35	13	93	106
Apprch %	36.4	45.5	18.2			17.1	46.3	36.6			33.3	33.3	33.3			0	74.3	25.7					
Total %	4.3	5.4	2.2		11.8	7.5	20.4	16.1		44.1	2.2	2.2	2.2		6.5	0	28	9.7		37.6	12.3	87.7	

Start Time	Harvill Avenue Southbound				Cajalco Expressway Westbound				Harvill Avenue Northbound				Cajalco Expressway Eastbound				Int. Total
	Left	Thru	Right	App. Total	Left	Thru	Right	App. Total	Left	Thru	Right	App. Total	Left	Thru	Right	App. Total	
Peak Hour Analysis From 04:00 PM to 04:45 PM - Peak 1 of 1																	
Peak Hour for Entire Intersection Begins at 04:00 PM																	
04:00 PM	1	0	1	2	1	7	3	11	0	0	1	1	0	5	3	8	22
04:15 PM	0	0	0	0	1	3	2	6	1	0	0	1	0	2	1	3	10
04:30 PM	1	1	0	2	0	3	4	7	0	0	0	0	0	3	1	4	13
04:45 PM	0	1	1	2	0	1	3	4	0	0	0	0	0	4	1	5	11
Total Volume	2	2	2	6	2	14	12	28	1	0	1	2	0	14	6	20	56
% App. Total	33.3	33.3	33.3		7.1	50	42.9		50	0	50		0	70	30		
PHF	.500	.500	.500	.750	.500	.500	.750	.636	.250	.000	.250	.500	.000	.700	.500	.625	.636

County of Riverside  
 N/S: Harvill Avenue  
 E/W: Cajalco Expressway  
 Weather: Clear

File Name : 18\_CRV\_Har\_Caj PM  
 Site Code : 05122112  
 Start Date : 2/8/2022  
 Page No : 2

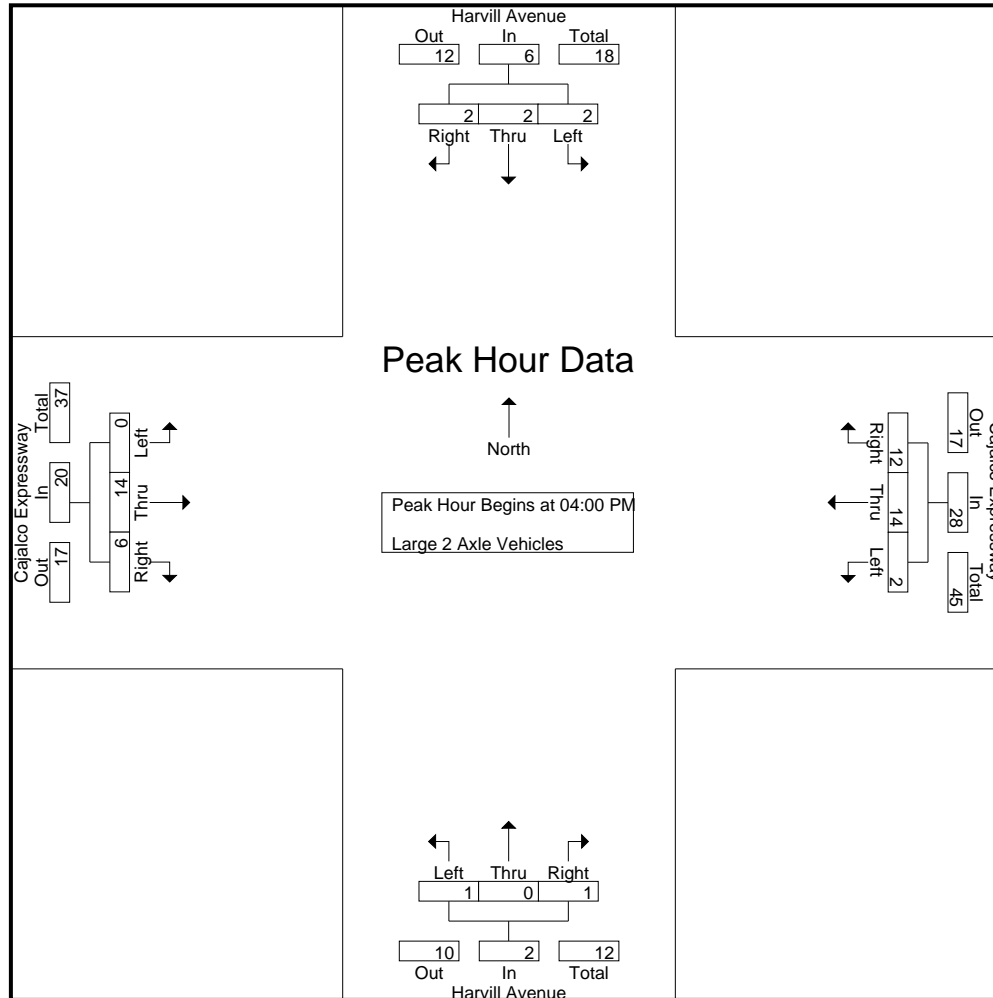

County of Riverside  
 N/S: Harvill Avenue  
 E/W: Cajalco Expressway  
 Weather: Clear

File Name : 18\_CRV\_Har\_Caj PM  
 Site Code : 05122112  
 Start Date : 2/8/2022  
 Page No : 3

Start Time	Harvill Avenue Southbound				Cajalco Expressway Westbound				Harvill Avenue Northbound				Cajalco Expressway Eastbound				Int. Total
	Left	Thru	Right	App. Total	Left	Thru	Right	App. Total	Left	Thru	Right	App. Total	Left	Thru	Right	App. Total	
Peak Hour Analysis From 04:00 PM to 04:45 PM - Peak 1 of 1																	
Peak Hour for Each Approach Begins at:																	
	04:00 PM				04:00 PM				04:00 PM				04:00 PM				
+0 mins.	1	0	1	2	1	7	3	11	0	0	1	1	0	5	3	8	
+15 mins.	0	0	0	0	1	3	2	6	1	0	0	1	0	2	1	3	
+30 mins.	1	1	0	2	0	3	4	7	0	0	0	0	0	3	1	4	
+45 mins.	0	1	1	2	0	1	3	4	0	0	0	0	0	4	1	5	
Total Volume	2	2	2	6	2	14	12	28	1	0	1	2	0	14	6	20	
% App. Total	33.3	33.3	33.3		7.1	50	42.9		50	0	50		0	70	30		
PHF	.500	.500	.500	.750	.500	.500	.750	.636	.250	.000	.250	.500	.000	.700	.500	.625	

County of Riverside  
 N/S: Harvill Avenue  
 E/W: Cajalco Expressway  
 Weather: Clear

File Name : 18\_CRV\_Har\_Caj PM  
 Site Code : 05122112  
 Start Date : 2/8/2022  
 Page No : 1

Groups Printed- 3 Axle Vehicles

Start Time	Harvill Avenue Southbound					Cajalco Expressway Westbound					Harvill Avenue Northbound					Cajalco Expressway Eastbound					Exclu. Total	Inclu. Total	Int. Total
	Left	Thru	Right	RTOR	App. Total	Left	Thru	Right	RTOR	App. Total	Left	Thru	Right	RTOR	App. Total	Left	Thru	Right	RTOR	App. Total			
04:00 PM	1	0	0	0	1	0	2	0	0	2	0	3	1	1	4	0	2	0	0	2	1	9	10
04:15 PM	0	0	0	0	0	2	1	0	0	3	0	1	1	1	2	0	1	0	0	1	1	6	7
04:30 PM	0	0	0	0	0	1	0	0	0	1	0	0	0	0	0	0	1	0	0	1	0	2	2
04:45 PM	0	0	0	0	0	1	0	0	0	1	1	0	0	0	1	0	0	0	0	0	0	2	2
Total	1	0	0	0	1	4	3	0	0	7	1	4	2	2	7	0	4	0	0	4	2	19	21
05:00 PM	1	0	0	0	1	0	2	0	0	2	0	0	0	0	0	0	0	0	0	0	0	3	3
05:15 PM	0	2	0	0	2	0	2	0	0	2	0	1	0	0	1	0	0	1	0	1	0	6	6
05:30 PM	0	0	0	0	0	0	1	0	0	1	0	0	0	0	0	0	0	0	0	0	0	1	1
05:45 PM	0	0	0	0	0	1	1	0	0	2	1	0	0	0	1	1	1	0	0	2	0	5	5
Total	1	2	0	0	3	1	6	0	0	7	1	1	0	0	2	1	1	1	0	3	0	15	15
Grand Total	2	2	0	0	4	5	9	0	0	14	2	5	2	2	9	1	5	1	0	7	2	34	36
Aprpch %	50	50	0			35.7	64.3	0			22.2	55.6	22.2			14.3	71.4	14.3					
Total %	5.9	5.9	0		11.8	14.7	26.5	0		41.2	5.9	14.7	5.9		26.5	2.9	14.7	2.9		20.6	5.6	94.4	

Start Time	Harvill Avenue Southbound				Cajalco Expressway Westbound				Harvill Avenue Northbound				Cajalco Expressway Eastbound				Int. Total
	Left	Thru	Right	App. Total	Left	Thru	Right	App. Total	Left	Thru	Right	App. Total	Left	Thru	Right	App. Total	
Peak Hour Analysis From 04:00 PM to 04:45 PM - Peak 1 of 1																	
Peak Hour for Entire Intersection Begins at 04:00 PM																	
04:00 PM	1	0	0	1	0	2	0	2	0	3	1	4	0	2	0	2	9
04:15 PM	0	0	0	0	2	1	0	3	0	1	1	2	0	1	0	1	6
04:30 PM	0	0	0	0	1	0	0	1	0	0	0	0	0	1	0	1	2
04:45 PM	0	0	0	0	1	0	0	1	1	0	0	1	0	0	0	0	2
Total Volume	1	0	0	1	4	3	0	7	1	4	2	7	0	4	0	4	19
% App. Total	100	0	0		57.1	42.9	0		14.3	57.1	28.6		0	100	0		
PHF	.250	.000	.000	.250	.500	.375	.000	.583	.250	.333	.500	.438	.000	.500	.000	.500	.528

County of Riverside  
 N/S: Harvill Avenue  
 E/W: Cajalco Expressway  
 Weather: Clear

File Name : 18\_CRV\_Har\_Caj PM  
 Site Code : 05122112  
 Start Date : 2/8/2022  
 Page No : 2

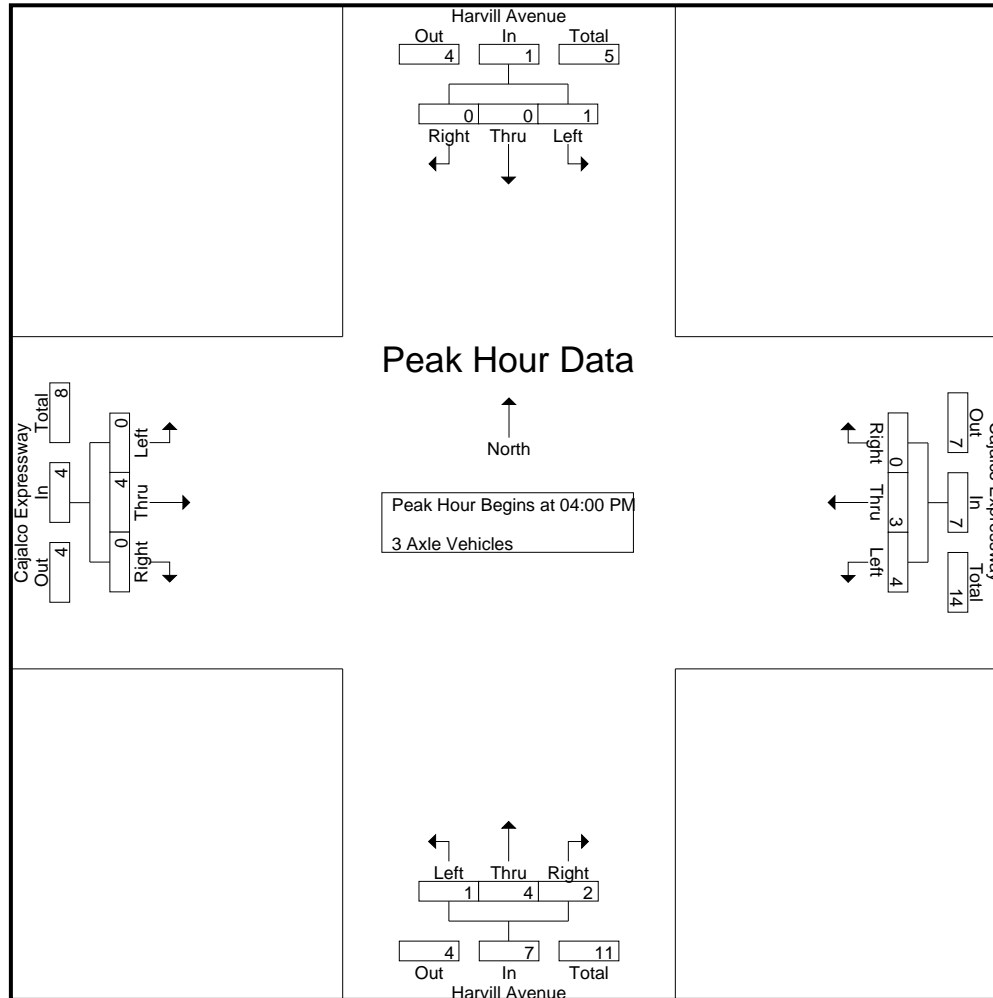



County of Riverside  
 N/S: Harvill Avenue  
 E/W: Cajalco Expressway  
 Weather: Clear

File Name : 18\_CRV\_Har\_Caj PM  
 Site Code : 05122112  
 Start Date : 2/8/2022  
 Page No : 3

Start Time	Harvill Avenue Southbound				Cajalco Expressway Westbound				Harvill Avenue Northbound				Cajalco Expressway Eastbound				Int. Total
	Left	Thru	Right	App. Total	Left	Thru	Right	App. Total	Left	Thru	Right	App. Total	Left	Thru	Right	App. Total	
Peak Hour Analysis From 04:00 PM to 04:45 PM - Peak 1 of 1																	
Peak Hour for Each Approach Begins at:																	
	04:00 PM				04:00 PM				04:00 PM				04:00 PM				
+0 mins.	1	0	0	1	0	2	0	2	0	3	1	4	0	2	0	2	
+15 mins.	0	0	0	0	2	1	0	3	0	1	1	2	0	1	0	1	
+30 mins.	0	0	0	0	1	0	0	1	0	0	0	0	0	1	0	1	
+45 mins.	0	0	0	0	1	0	0	1	1	0	0	1	0	0	0	0	
Total Volume	1	0	0	1	4	3	0	7	1	4	2	7	0	4	0	4	
% App. Total	100	0	0		57.1	42.9	0		14.3	57.1	28.6		0	100	0		
PHF	.250	.000	.000	.250	.500	.375	.000	.583	.250	.333	.500	.438	.000	.500	.000	.500	

County of Riverside  
 N/S: Harvill Avenue  
 E/W: Cajalco Expressway  
 Weather: Clear

File Name : 18\_CRV\_Har\_Caj PM  
 Site Code : 05122112  
 Start Date : 2/8/2022  
 Page No : 1

Groups Printed- 4+ Axle Trucks

Start Time	Harvill Avenue Southbound					Cajalco Expressway Westbound					Harvill Avenue Northbound					Cajalco Expressway Eastbound					Exclu. Total	Inclu. Total	Int. Total
	Left	Thru	Right	RTOR	App. Total	Left	Thru	Right	RTOR	App. Total	Left	Thru	Right	RTOR	App. Total	Left	Thru	Right	RTOR	App. Total			
04:00 PM	0	2	1	1	3	8	5	1	1	14	1	0	1	1	2	1	4	1	0	6	3	25	28
04:15 PM	0	0	0	0	0	2	4	0	0	6	0	0	1	0	1	0	6	0	0	6	0	13	13
04:30 PM	1	1	0	0	2	2	3	1	0	6	1	0	0	0	1	0	2	0	0	2	0	11	11
04:45 PM	0	2	0	0	2	1	3	1	0	5	0	0	1	0	1	0	1	1	0	2	0	10	10
Total	1	5	1	1	7	13	15	3	1	31	2	0	3	1	5	1	13	2	0	16	3	59	62
05:00 PM	1	1	1	0	3	3	4	1	0	8	0	1	1	0	2	0	1	1	1	2	1	15	16
05:15 PM	0	2	0	0	2	5	2	0	0	7	0	1	0	0	1	3	3	0	0	6	0	16	16
05:30 PM	0	0	0	0	0	6	3	0	0	9	0	0	1	1	1	0	2	1	0	3	1	13	14
05:45 PM	1	1	1	0	3	4	2	0	0	6	1	0	1	1	2	0	3	2	0	5	1	16	17
Total	2	4	2	0	8	18	11	1	0	30	1	2	3	2	6	3	9	4	1	16	3	60	63
Grand Total	3	9	3	1	15	31	26	4	1	61	3	2	6	3	11	4	22	6	1	32	6	119	125
Apprch %	20	60	20			50.8	42.6	6.6			27.3	18.2	54.5			12.5	68.8	18.8					
Total %	2.5	7.6	2.5		12.6	26.1	21.8	3.4		51.3	2.5	1.7	5		9.2	3.4	18.5	5		26.9	4.8	95.2	

Start Time	Harvill Avenue Southbound				Cajalco Expressway Westbound				Harvill Avenue Northbound				Cajalco Expressway Eastbound				Int. Total
	Left	Thru	Right	App. Total	Left	Thru	Right	App. Total	Left	Thru	Right	App. Total	Left	Thru	Right	App. Total	
Peak Hour Analysis From 04:00 PM to 04:45 PM - Peak 1 of 1																	
Peak Hour for Entire Intersection Begins at 04:00 PM																	
04:00 PM	0	2	1	3	8	5	1	14	1	0	1	2	1	4	1	6	25
04:15 PM	0	0	0	0	2	4	0	6	0	0	1	1	0	6	0	6	13
04:30 PM	1	1	0	2	2	3	1	6	1	0	0	1	0	2	0	2	11
04:45 PM	0	2	0	2	1	3	1	5	0	0	1	1	0	1	1	2	10
Total Volume	1	5	1	7	13	15	3	31	2	0	3	5	1	13	2	16	59
% App. Total	14.3	71.4	14.3		41.9	48.4	9.7		40	0	60		6.2	81.2	12.5		
PHF	.250	.625	.250	.583	.406	.750	.750	.554	.500	.000	.750	.625	.250	.542	.500	.667	.590

County of Riverside  
 N/S: Harvill Avenue  
 E/W: Cajalco Expressway  
 Weather: Clear

File Name : 18\_CRV\_Har\_Caj PM  
 Site Code : 05122112  
 Start Date : 2/8/2022  
 Page No : 2

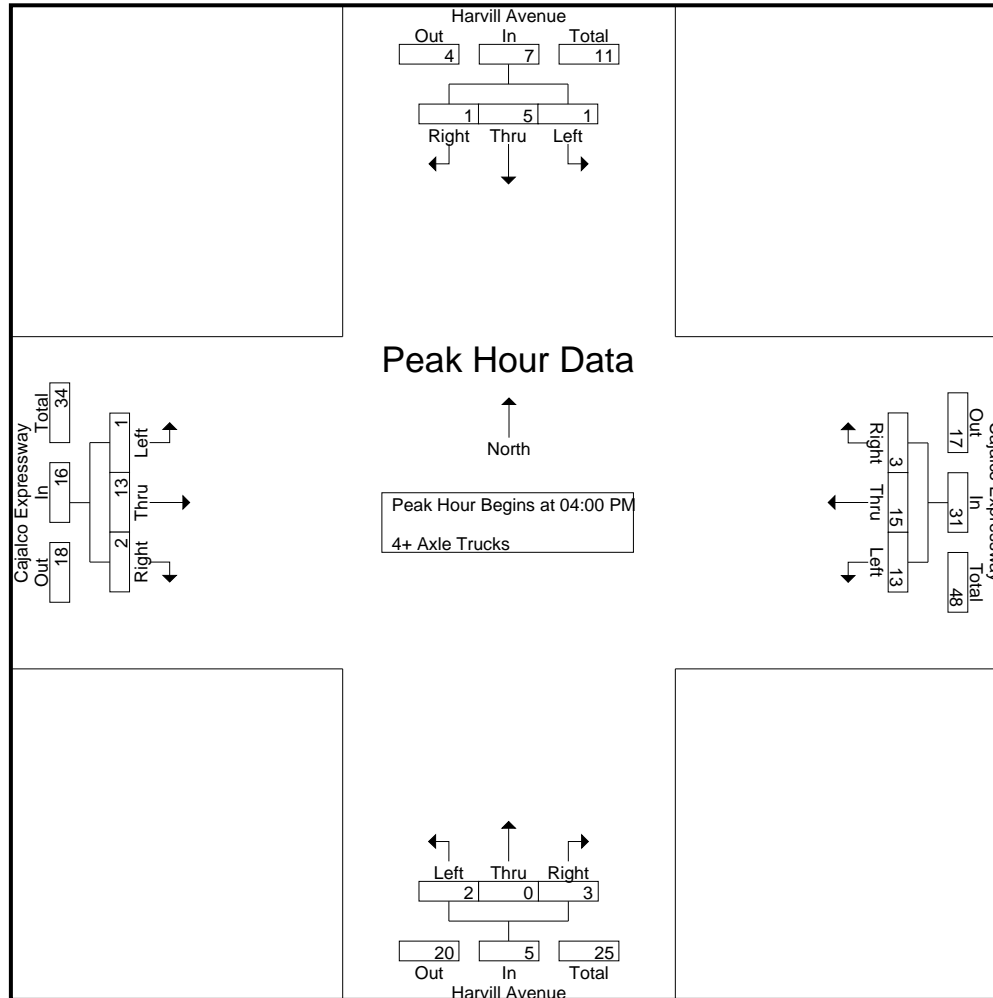

County of Riverside  
 N/S: Harvill Avenue  
 E/W: Cajalco Expressway  
 Weather: Clear

File Name : 18\_CRV\_Har\_Caj PM  
 Site Code : 05122112  
 Start Date : 2/8/2022  
 Page No : 3

Start Time	Harvill Avenue Southbound				Cajalco Expressway Westbound				Harvill Avenue Northbound				Cajalco Expressway Eastbound				Int. Total
	Left	Thru	Right	App. Total	Left	Thru	Right	App. Total	Left	Thru	Right	App. Total	Left	Thru	Right	App. Total	
Peak Hour Analysis From 04:00 PM to 04:45 PM - Peak 1 of 1																	
Peak Hour for Each Approach Begins at:																	
	04:00 PM				04:00 PM				04:00 PM				04:00 PM				
+0 mins.	0	2	1	3	8	5	1	14	1	0	1	2	1	4	1	6	
+15 mins.	0	0	0	0	2	4	0	6	0	0	1	1	0	6	0	6	
+30 mins.	1	1	0	2	2	3	1	6	1	0	0	1	0	2	0	2	
+45 mins.	0	2	0	2	1	3	1	5	0	0	1	1	0	1	1	2	
Total Volume	1	5	1	7	13	15	3	31	2	0	3	5	1	13	2	16	
% App. Total	14.3	71.4	14.3		41.9	48.4	9.7		40	0	60		6.2	81.2	12.5		
PHF	.250	.625	.250	.583	.406	.750	.750	.554	.500	.000	.750	.625	.250	.542	.500	.667	

Location: County of Riverside  
 N/S: Harvill Avenue  
 E/W: Cajalco Expressway



Date: 2/8/2022  
 Day: Tuesday

PEDESTRIANS

	North Leg Harvill Avenue	East Leg Cajalco Expressway	South Leg Harvill Avenue	West Leg Cajalco Expressway	
	Pedestrians	Pedestrians	Pedestrians	Pedestrians	
7:00 AM	0	0	0	0	0
7:15 AM	0	0	0	0	0
7:30 AM	0	0	0	0	0
7:45 AM	0	0	0	0	0
8:00 AM	0	0	0	0	0
8:15 AM	0	0	0	0	0
8:30 AM	0	0	0	0	0
8:45 AM	0	0	0	0	0
TOTAL VOLUMES:	0	0	0	0	0

	North Leg Harvill Avenue	East Leg Cajalco Expressway	South Leg Harvill Avenue	West Leg Cajalco Expressway	
	Pedestrians	Pedestrians	Pedestrians	Pedestrians	
4:00 PM	0	0	0	0	0
4:15 PM	0	0	0	0	0
4:30 PM	0	0	0	0	0
4:45 PM	0	0	0	0	0
5:00 PM	0	0	0	0	0
5:15 PM	0	0	0	0	0
5:30 PM	0	0	0	0	0
5:45 PM	0	0	0	0	0
TOTAL VOLUMES:	0	0	0	0	0

Location: County of Riverside  
 N/S: Harvill Avenue  
 E/W: Cajalco Expressway



Date: 2/8/2022  
 Day: Tuesday

BICYCLES

	Southbound Harvill Avenue			Westbound Cajalco Expressway			Northbound Harvill Avenue			Eastbound Cajalco Expressway			
	Left	Thru	Right	Left	Thru	Right	Left	Thru	Right	Left	Thru	Right	
7:00 AM	0	0	0	0	0	0	0	0	0	0	0	0	0
7:15 AM	0	0	0	0	0	0	0	0	0	0	0	1	1
7:30 AM	0	0	0	0	0	0	0	0	0	0	0	0	0
7:45 AM	0	0	0	0	0	0	0	0	0	0	0	0	0
8:00 AM	0	0	0	0	0	0	0	0	0	0	0	0	0
8:15 AM	0	0	0	0	0	0	0	0	0	0	0	0	0
8:30 AM	0	0	0	0	0	0	0	0	0	0	0	0	0
8:45 AM	0	0	0	0	0	0	0	0	0	0	0	0	0
TOTAL VOLUMES:	0	0	0	0	0	0	0	0	0	0	0	1	1

	Southbound Harvill Avenue			Westbound Cajalco Expressway			Northbound Harvill Avenue			Eastbound Cajalco Expressway			
	Left	Thru	Right	Left	Thru	Right	Left	Thru	Right	Left	Thru	Right	
4:00 PM	0	0	0	0	0	0	0	0	0	0	0	0	0
4:15 PM	0	0	0	0	0	0	0	0	0	0	0	0	0
4:30 PM	0	0	0	0	0	0	0	0	0	0	0	0	0
4:45 PM	0	0	0	0	0	0	0	0	0	0	0	0	0
5:00 PM	0	0	0	0	0	0	0	0	0	0	1	0	1
5:15 PM	0	0	0	0	0	0	0	0	0	0	0	0	0
5:30 PM	0	0	0	0	0	0	0	0	0	0	0	0	0
5:45 PM	0	0	0	0	0	0	0	1	0	0	0	0	1
TOTAL VOLUMES:	0	0	0	0	0	0	0	1	0	0	1	0	2



**AimTD LLC**  
TURNING MOVEMENT COUNTS

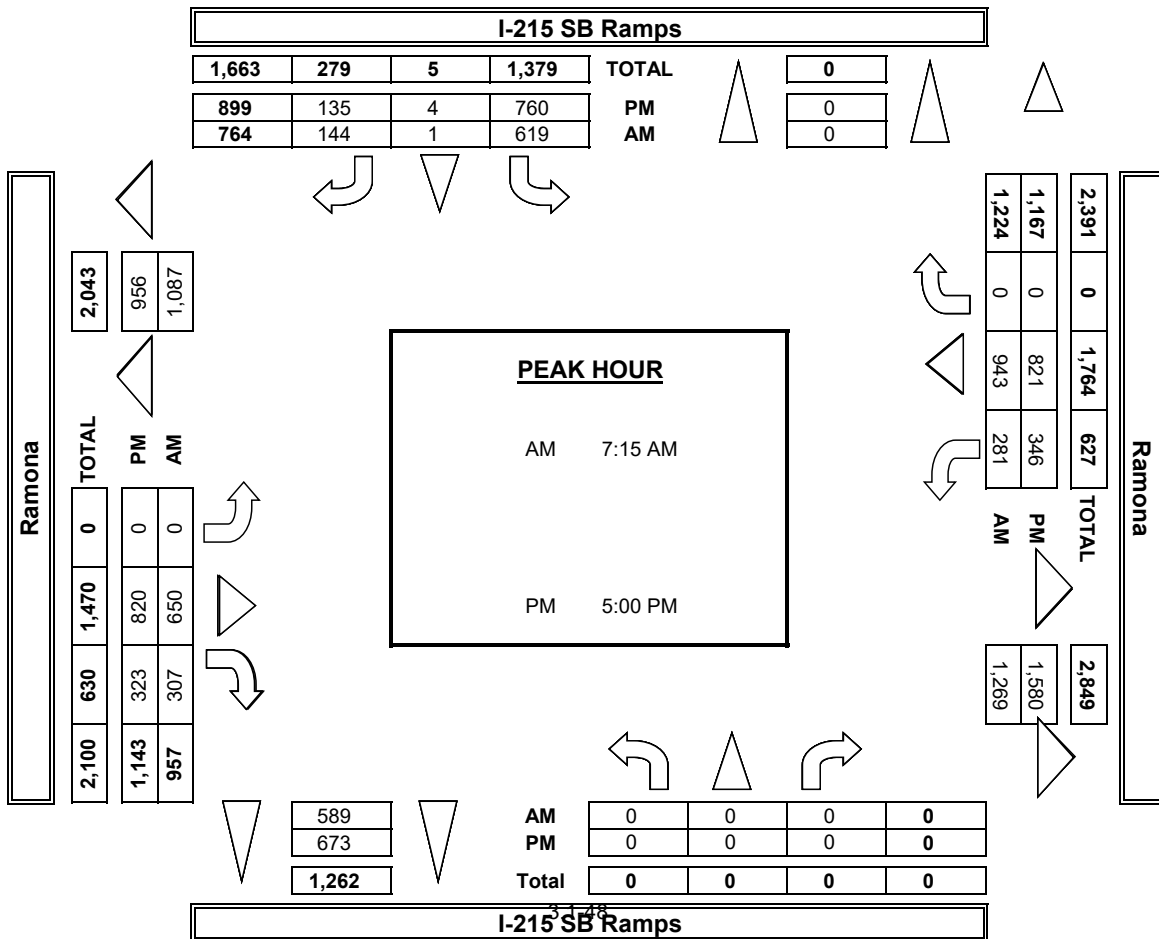
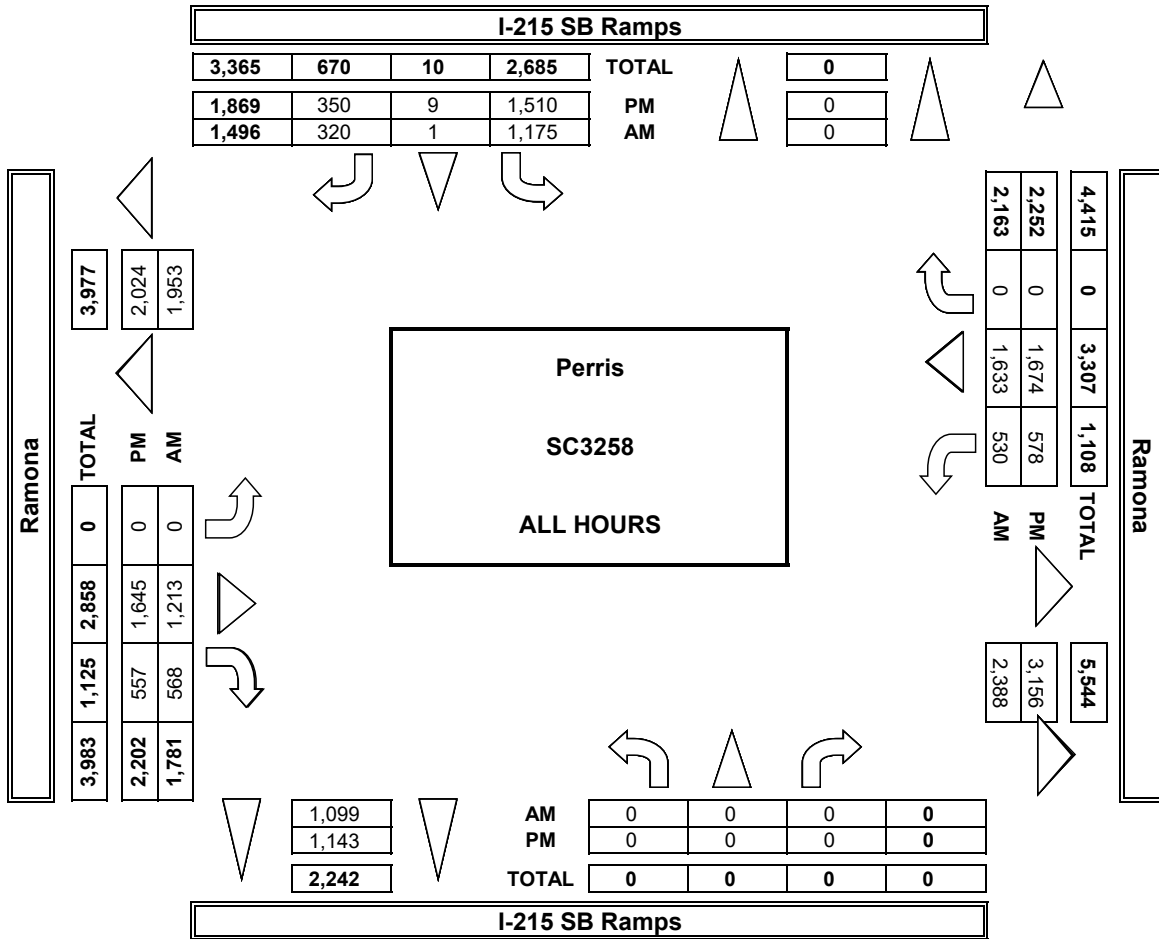



### INTERSECTION TURNING MOVEMENT COUNTS

PREPARED BY: AimTD LLC. tel: 714 253 7888 cs@aimtd.com

DATE: 1/25/22 TUESDAY	LOCATION: NORTH & SOUTH: EAST & WEST:	Perris I-215 SB Ramps Ramona	PROJECT #: LOCATION #: CONTROL:	SC3258 1 SIGNAL
-----------------------------	---	------------------------------------	---------------------------------------	-----------------------

<b>CLASS 2:</b> 2-AXLE WORK VEHICLES/ TRUCKS	<b>NOTES:</b>
--	---------------

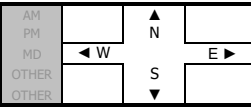

LANES:	NORTHBOUND			SOUTHBOUND			EASTBOUND			WESTBOUND			TOTAL
	NL	NT	NR	SL	ST	SR	EL	ET	ER	WL	WT	WR	
	X	X	X	1.5	0.5	1	X	2	0	1	2	X	

U-TURNS				
NB	SB	EB	WB	TTL
0	0	0	0	0

RTOR			
NRR	SRR	ERR	WRR
X	0	0	X

AM	7:00 AM	0	0	0	39	0	9	0	15	6	9	16	0	94
	7:15 AM	0	0	0	17	0	3	0	14	8	6	30	0	78
	7:30 AM	0	0	0	25	0	1	0	6	9	11	22	0	74
	7:45 AM	0	0	0	20	1	5	0	16	7	11	18	0	78
	8:00 AM	0	0	0	17	0	7	0	13	6	9	23	0	75
	8:15 AM	0	0	0	15	0	2	0	9	7	8	20	0	61
	8:30 AM	0	0	0	18	0	7	0	14	7	4	14	0	64
	8:45 AM	0	0	0	14	0	10	0	8	9	8	20	0	69
	VOLUMES	0	0	0	165	1	44	0	95	59	66	163	0	593
	APPROACH %	0%	0%	0%	79%	0%	21%	0%	62%	38%	29%	71%	0%	
APP/DEPART	0	/	0	210	/	126	154	/	260	229	/	207	0	
BEGIN PEAK HR	7:15 AM													
VOLUMES	0	0	0	79	1	16	0	49	30	37	93	0	305	
APPROACH %	0%	0%	0%	82%	1%	17%	0%	62%	38%	28%	72%	0%		
PEAK HR FACTOR	0.000			0.923			0.859			0.903			0.978	
APP/DEPART	0	/	0	96	/	68	79	/	128	130	/	109	0	
PM	4:00 PM	0	0	0	10	1	3	0	16	3	4	14	0	51
	4:15 PM	0	0	0	11	0	7	0	14	4	3	13	0	52
	4:30 PM	0	0	0	10	0	7	0	18	4	3	20	0	62
	4:45 PM	0	0	0	11	0	1	0	13	6	0	8	0	39
	5:00 PM	0	0	0	6	0	3	0	21	7	0	12	0	49
	5:15 PM	0	0	0	10	2	3	0	10	10	2	19	0	56
	5:30 PM	0	0	0	9	0	4	0	9	1	5	9	0	37
	5:45 PM	0	0	0	13	1	2	0	10	1	2	8	0	37
	VOLUMES	0	0	0	80	4	30	0	111	36	19	103	0	383
	APPROACH %	0%	0%	0%	70%	4%	26%	0%	76%	24%	16%	84%	0%	
APP/DEPART	0	/	0	114	/	59	147	/	191	122	/	133	0	
BEGIN PEAK HR	5:00 PM													
VOLUMES	0	0	0	38	3	12	0	50	19	9	48	0	179	
APPROACH %	0%	0%	0%	72%	6%	23%	0%	72%	28%	16%	84%	0%		
PEAK HR FACTOR	0.000			0.828			0.616			0.679			0.799	
APP/DEPART	0	/	0	53	/	31	69	/	88	57	/	60	0	

0	0	0	0	0
0	0	0	0	0
0	0	0	0	0
0	0	0	0	0
0	0	0	0	0
0	0	0	0	0
0	0	0	0	0
0	0	0	0	0
0	0	0	0	0
0	0	0	0	0

0	3	2	0
0	2	3	0
0	0	4	0
0	2	6	0
0	3	3	0
0	1	3	0
0	4	3	0
0	4	5	0
0	19	29	0

0	7	16	0
---	---	----	---

0	0	0	0	0
0	0	0	0	0
0	0	0	0	0
0	0	0	0	0
0	0	0	0	0
0	0	0	0	0
0	0	0	0	0
0	0	0	0	0
0	0	0	0	0
0	0	0	0	0

0	3	3	0
0	1	1	0
0	4	0	0
0	0	2	0
0	2	2	0
0	2	3	0
0	1	0	0
0	1	0	0
0	14	11	0

0	6	5	0
---	---	---	---

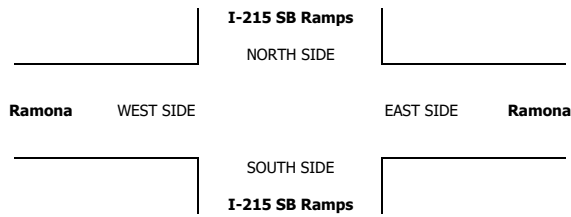

### INTERSECTION TURNING MOVEMENT COUNTS

PREPARED BY: AimTD LLC. tel: 714 253 7888 cs@aimtd.com

DATE: 1/25/22 TUESDAY	LOCATION: NORTH & SOUTH: EAST & WEST:	Perris I-215 SB Ramps Ramona	PROJECT #: LOCATION #: CONTROL:	SC3258 1 SIGNAL																				
<b>CLASS 3:</b> 3-AXLE TRUCKS	<b>NOTES:</b>		<table border="1" style="margin: auto;"> <tr><td>AM</td><td></td><td>▲</td><td></td></tr> <tr><td>PM</td><td></td><td>N</td><td></td></tr> <tr><td>MD</td><td>◀ W</td><td></td><td>E ▶</td></tr> <tr><td>OTHER</td><td></td><td>S</td><td></td></tr> <tr><td>OTHER</td><td></td><td>▼</td><td></td></tr> </table>	AM		▲		PM		N		MD	◀ W		E ▶	OTHER		S		OTHER		▼		
AM		▲																						
PM		N																						
MD	◀ W		E ▶																					
OTHER		S																						
OTHER		▼																						

	NORTHBOUND			SOUTHBOUND			EASTBOUND			WESTBOUND			TOTAL
	I-215 SB Ramps			I-215 SB Ramps			Ramona			Ramona			
LANES:	NL X	NT X	NR X	SL 1.5	ST 0.5	SR 1	EL X	ET 2	ER 0	WL 1	WT 2	WR X	
7:00 AM	0	0	0	7	0	0	0	7	7	0	1	0	22
7:15 AM	0	0	0	4	0	0	0	18	4	1	11	0	38
7:30 AM	0	0	0	3	0	0	0	5	5	0	2	0	15
7:45 AM	0	0	0	2	0	1	0	5	2	0	4	0	14
8:00 AM	0	0	0	5	0	1	0	4	5	1	6	0	22
8:15 AM	0	0	0	1	0	3	0	8	2	2	7	0	23
8:30 AM	0	0	0	2	0	2	0	8	3	0	0	0	15
8:45 AM	0	0	0	2	0	2	0	11	3	1	4	0	23
VOLUMES	0	0	0	26	0	9	0	66	31	5	35	0	172
APPROACH %	0%	0%	0%	74%	0%	26%	0%	68%	32%	13%	88%	0%	
APP/DEPART	0	/	0	35	/	36	97	/	92	40	/	44	0
BEGIN PEAK HR	7:15 AM												
VOLUMES	0	0	0	14	0	2	0	32	16	2	23	0	89
APPROACH %	0%	0%	0%	88%	0%	13%	0%	67%	33%	8%	92%	0%	
PEAK HR FACTOR	0.000			0.667			0.545			0.521			0.586
APP/DEPART	0	/	0	16	/	18	48	/	46	25	/	25	0
4:00 PM	0	0	0	1	0	3	0	4	2	0	2	0	12
4:15 PM	0	0	0	5	0	1	0	2	0	0	2	0	10
4:30 PM	0	0	0	2	0	0	0	7	1	0	0	0	10
4:45 PM	0	0	0	2	0	0	0	5	2	0	4	0	13
5:00 PM	0	0	0	2	0	1	0	1	0	0	2	0	6
5:15 PM	0	0	0	1	0	0	0	1	1	1	2	0	6
5:30 PM	0	0	0	1	0	2	0	1	0	1	4	0	9
5:45 PM	0	0	0	2	0	0	0	0	0	0	4	0	6
VOLUMES	0	0	0	16	0	7	0	21	6	2	20	0	72
APPROACH %	0%	0%	0%	70%	0%	30%	0%	78%	22%	9%	91%	0%	
APP/DEPART	0	/	0	23	/	8	27	/	37	22	/	27	0
BEGIN PEAK HR	5:00 PM												
VOLUMES	0	0	0	6	0	3	0	3	1	2	12	0	27
APPROACH %	0%	0%	0%	67%	0%	33%	0%	75%	25%	14%	86%	0%	
PEAK HR FACTOR	0.000			0.750			0.500			0.700			0.750
APP/DEPART	0	/	0	9	/	3	4	/	9	14	/	15	0

U-TURNS				
NB	SB	EB	WB	TTL
0	0	0	0	0
0	0	0	0	0
0	0	0	0	0
0	0	0	0	0
0	0	0	0	0
0	0	0	0	0
0	0	0	0	0
0	0	0	0	0
0	0	0	0	0
0	0	0	0	0

RTOR			
NRR	SRR	ERR	WRR
X	0	0	X
0	0	2	0
0	0	2	0
0	0	2	0
0	1	0	0
0	0	0	0
0	3	1	0
0	1	2	0
0	0	1	0
0	5	10	0

0	1	4	0
---	---	---	---

0	0	0	0	0
0	0	0	0	0
0	0	0	0	0
0	0	0	0	0
0	0	0	0	0
0	0	0	0	0
0	0	0	0	0
0	0	0	0	0
0	0	0	0	0
0	0	0	0	0

0	0	1	0
0	0	0	0
0	0	0	0
0	0	0	0
0	0	0	0
0	0	0	0
0	0	1	0
0	1	0	0
0	0	0	0
0	1	2	0

0	1	1	0
---	---	---	---

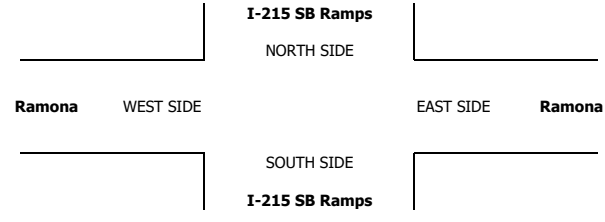

### INTERSECTION TURNING MOVEMENT COUNTS

PREPARED BY: AimTD LLC. tel: 714 253 7888 cs@aimtd.com

DATE: 1/25/22 TUESDAY	LOCATION: NORTH & SOUTH: EAST & WEST:	Perris I-215 SB Ramps Ramona	PROJECT #: LOCATION #: CONTROL:	SC3258 1 SIGNAL
-----------------------------	---	------------------------------------	---------------------------------------	-----------------------

<b>CLASS 4:</b> 4 OR MORE AXLE TRUCKS	<b>NOTES:</b>	AM PM MD OTHER	← W S ↓	N E ↑
--	---------------	-------------------------	---------------	-------------

LANES:	NORTHBOUND			SOUTHBOUND			EASTBOUND			WESTBOUND			TOTAL
	NL	NT	NR	SL	ST	SR	EL	ET	ER	WL	WT	WR	
	X	X	X	1.5	0.5	1	X	2	0	1	2	X	

U-TURNS				
NB	SB	EB	WB	TTL
0	0	0	0	0

RTOR			
NRR	SRR	ERR	WRR
X	0	0	X

AM	7:00 AM	0	0	0	11	0	9	0	16	6	1	15	0	58
	7:15 AM	0	0	0	14	0	1	0	5	2	4	17	0	43
	7:30 AM	0	0	0	21	0	6	0	3	5	4	15	0	54
	7:45 AM	0	0	0	21	0	7	0	9	3	5	9	0	54
	8:00 AM	0	0	0	16	0	14	0	9	3	0	13	0	55
	8:15 AM	0	0	0	20	0	6	0	10	8	3	14	0	61
	8:30 AM	0	0	0	25	0	5	0	14	3	3	1	0	51
	8:45 AM	0	0	0	22	0	8	0	10	3	2	17	0	62
	VOLUMES	0	0	0	150	0	56	0	76	33	22	101	0	438
	APPROACH %	0%	0%	0%	73%	0%	27%	0%	70%	30%	18%	82%	0%	
APP/DEPART	0	/	0	206	/	55	109	/	226	123	/	157	0	
BEGIN PEAK HR	7:15 AM													
VOLUMES	0	0	0	72	0	28	0	26	13	13	54	0	206	
APPROACH %	0%	0%	0%	72%	0%	28%	0%	67%	33%	19%	81%	0%		
PEAK HR FACTOR	0.000			0.833			0.813			0.798			0.936	
APP/DEPART	0	/	0	100	/	26	39	/	98	67	/	82	0	
PM	4:00 PM	0	0	0	7	0	3	0	6	2	0	5	0	23
	4:15 PM	0	0	0	7	0	6	0	5	0	2	12	0	32
	4:30 PM	0	0	0	9	0	3	0	3	1	0	9	0	25
	4:45 PM	0	0	0	11	0	2	0	3	3	2	5	0	26
	5:00 PM	0	0	0	11	0	9	0	4	3	3	5	0	35
	5:15 PM	0	0	0	10	0	5	0	7	3	2	6	0	33
	5:30 PM	0	0	0	7	1	4	0	2	1	1	7	0	23
	5:45 PM	0	0	0	6	0	2	0	5	0	2	4	0	19
	VOLUMES	0	0	0	68	1	34	0	35	13	12	53	0	216
	APPROACH %	0%	0%	0%	66%	1%	33%	0%	73%	27%	18%	82%	0%	
APP/DEPART	0	/	0	103	/	26	48	/	103	65	/	87	0	
BEGIN PEAK HR	5:00 PM													
VOLUMES	0	0	0	34	1	20	0	18	7	8	22	0	110	
APPROACH %	0%	0%	0%	62%	2%	36%	0%	72%	28%	27%	73%	0%		
PEAK HR FACTOR	0.000			0.688			0.625			0.938			0.786	
APP/DEPART	0	/	0	55	/	16	25	/	52	30	/	42	0	

0	0	0	0	0
0	0	0	0	0
0	0	0	0	0
0	0	0	0	0
0	0	0	0	0
0	0	0	0	0
0	0	0	0	0
0	0	0	0	0
0	0	0	0	0
0	0	0	0	0

0	0	1	0
0	1	2	0
0	2	0	0
0	4	1	0
0	5	1	0
0	2	2	0
0	3	1	0
0	5	1	0
0	22	9	0

0	12	4	0
---	----	---	---

0	0	0	0	0
0	0	0	0	0
0	0	0	0	0
0	0	0	0	0
0	0	0	0	0
0	0	0	0	0
0	0	0	0	0
0	0	0	0	0
0	0	0	0	0
0	0	0	0	0

0	1	1	0
0	0	0	0
0	1	0	0
0	0	1	0
0	4	2	0
0	3	1	0
0	0	0	0
0	0	0	0
0	0	0	0
0	9	5	0

0	7	3	0
---	---	---	---

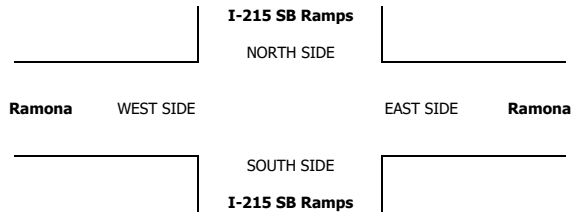

**INTERSECTION TURNING MOVEMENT COUNTS**

PREPARED BY: AimTD LLC. tel: 714 253 7888 cs@aimtd.com

<b>DATE:</b> Tue, Jan 25, 22	<b>LOCATION:</b> NORTH & SOUTH: EAST & WEST:	Perris I-215 NB Ramps Ramona	<b>PROJECT #:</b> SC3258 <b>LOCATION #:</b> 2 <b>CONTROL:</b> SIGNAL
---------------------------------	--	------------------------------------	---

<b>NOTES:</b>	AP	▲	<input type="checkbox"/> Add U-Turns to Left Turns	
	PM	N		
	MD	◀ W		E ▶
	OTHER	S		▼

LANES:	NORTHBOUND I-215 NB Ramps			SOUTHBOUND I-215 NB Ramps			EASTBOUND Ramona			WESTBOUND Ramona			TOTAL
	NL 1.5	NT 0.5	NR 1	SL X	ST X	SR X	EL 1	ET 2	ER X	WL X	WT 2	WR 1	

U-TURNS				
NB	SB	EB	WB	TTL

RTOR			
NRR	SRR	ERR	WRR

<b>7:00 AM</b>	67	1	143	0	0	0	32	253	0	0	184	147	827
<b>7:15 AM</b>	89	0	154	0	0	0	28	279	0	0	239	153	942
<b>7:30 AM</b>	71	0	133	0	0	0	20	278	0	0	236	166	904
<b>7:45 AM</b>	77	3	142	0	0	0	23	325	0	0	216	108	894
<b>8:00 AM</b>	77	0	123	0	0	0	29	285	0	0	219	172	905
<b>8:15 AM</b>	60	2	99	0	0	0	32	277	0	0	189	166	825
<b>8:30 AM</b>	50	0	93	0	0	0	32	244	0	0	166	143	728
<b>8:45 AM</b>	61	0	95	0	0	0	44	205	0	0	163	137	705
<b>VOLUMES</b>	552	6	982	0	0	0	240	2,146	0	0	1,612	1,192	6,730
<b>APPROACH %</b>	36%	0%	64%	0%	0%	0%	10%	90%	0%	0%	57%	43%	
<b>APP/DEPART</b>	1,540	/	1,438	0	/	0	2,386	/	3,128	2,804	/	2,164	0

0	0	0	0	0
0	0	0	0	0
0	0	0	0	0
0	0	0	0	0
0	0	0	0	0
0	0	0	0	0
0	0	0	0	0
0	0	0	0	0
0	0	0	0	0
0	0	0	0	0

39	0	0	30
42	0	0	34
39	0	0	42
26	0	0	28
40	0	0	40
21	0	0	39
29	0	0	24
38	0	0	29
274	0	0	266

<b>BEGIN PEAK HR</b>	7:15 AM												
<b>VOLUMES</b>	314	3	552	0	0	0	100	1,167	0	0	910	599	3,645
<b>APPROACH %</b>	36%	0%	64%	0%	0%	0%	8%	92%	0%	0%	60%	40%	
<b>PEAK HR FACTOR</b>	0.894			0.000			0.910			0.938			0.967
<b>APP/DEPART</b>	869	/	702	0	/	0	1,267	/	1,719	1,509	/	1,224	0

0	0	0	0	0
0	0	0	0	0
0	0	0	0	0
0	0	0	0	0
0	0	0	0	0
0	0	0	0	0
0	0	0	0	0
0	0	0	0	0
0	0	0	0	0
0	0	0	0	0

147	0	0	144
-----	---	---	-----

<b>4:00 PM</b>	84	1	106	0	0	0	25	414	0	0	202	145	977
<b>4:15 PM</b>	78	1	116	0	0	0	24	333	0	0	185	153	890
<b>4:30 PM</b>	76	0	106	0	0	0	26	358	0	0	216	145	927
<b>4:45 PM</b>	59	1	97	0	0	0	25	371	0	0	185	140	878
<b>5:00 PM</b>	81	0	92	0	0	0	42	324	0	0	223	88	850
<b>5:15 PM</b>	80	1	100	0	0	0	37	349	0	0	202	127	896
<b>5:30 PM</b>	85	0	117	0	0	0	35	368	0	0	218	155	978
<b>5:45 PM</b>	73	0	106	0	0	0	24	397	0	0	199	131	930
<b>VOLUMES</b>	615	4	840	0	0	0	238	2,914	0	0	1,630	1,084	7,326
<b>APPROACH %</b>	42%	0%	58%	0%	0%	0%	8%	92%	0%	0%	60%	40%	
<b>APP/DEPART</b>	1,460	/	1,326	0	/	0	3,152	/	3,754	2,714	/	2,246	0
<b>BEGIN PEAK HR</b>	4:00 PM												
<b>VOLUMES</b>	297	3	425	0	0	0	100	1,476	0	0	788	583	3,672
<b>APPROACH %</b>	41%	0%	59%	0%	0%	0%	6%	94%	0%	0%	57%	43%	
<b>PEAK HR FACTOR</b>	0.929			0.000			0.897			0.949			0.940
<b>APP/DEPART</b>	725	/	686	0	/	0	1,576	/	1,901	1,371	/	1,085	0

0	0	0	0	0
0	0	0	0	0
0	0	0	0	0
0	0	0	0	0
0	0	0	0	0
0	0	0	0	0
0	0	0	0	0
0	0	0	0	0
0	0	0	0	0
0	0	0	0	0

15	0	0	34
15	0	0	39
22	0	0	34
24	0	0	34
22	0	0	26
19	0	0	25
21	0	0	35
12	0	0	31
150	0	0	258

76	0	0	141
----	---	---	-----



<b>7:00 AM</b>	0	0	0	0	0
<b>7:15 AM</b>	0	0	0	0	0
<b>7:30 AM</b>	0	0	0	0	0
<b>7:45 AM</b>	0	0	0	0	0
<b>8:00 AM</b>	0	0	0	0	0
<b>8:15 AM</b>	0	0	0	0	0
<b>8:30 AM</b>	0	0	0	0	0
<b>8:45 AM</b>	0	0	0	0	0
<b>TOTAL</b>	0	0	0	0	0
<b>4:00 PM</b>	0	0	0	1	1
<b>4:15 PM</b>	0	0	0	0	0
<b>4:30 PM</b>	0	0	0	0	0
<b>4:45 PM</b>	0	0	0	0	0
<b>5:00 PM</b>	0	0	0	1	1
<b>5:15 PM</b>	0	0	0	1	1
<b>5:30 PM</b>	0	0	1	1	2
<b>5:45 PM</b>	0	0	0	0	0
<b>TOTAL</b>	0	0	1	4	5

ALL PED AND BIKE				
E SIDE	W SIDE	S SIDE	N SIDE	TOTAL
0	0	0	0	0
0	0	0	0	0
0	0	0	0	0
0	0	0	0	0
0	0	0	0	0
0	0	0	0	0
0	0	0	0	0
0	0	0	0	0
0	0	0	0	0
0	0	0	0	0
0	0	0	1	1
0	0	0	0	0
0	0	0	0	0
0	0	0	0	0
0	0	0	1	1
0	0	1	1	2
0	0	0	0	0
0	0	1	4	5

PEDESTRIAN CROSSINGS				
E SIDE	W SIDE	S SIDE	N SIDE	TOTAL
0	0	0	0	0
0	0	0	0	0
0	0	0	0	0
0	0	0	0	0
0	0	0	0	0
0	0	0	0	0
0	0	0	0	0
0	0	0	0	0
0	0	0	0	0
0	0	0	0	0
0	0	0	1	1
0	0	0	0	0
0	0	0	0	0
0	0	0	1	1
0	0	0	1	1
0	0	0	4	4

BICYCLE CROSSINGS				
ES	WS	SS	NS	TOTAL
0	0	0	0	0
0	0	0	0	0
0	0	0	0	0
0	0	0	0	0
0	0	0	0	0
0	0	0	0	0
0	0	0	0	0
0	0	0	0	0
0	0	0	0	0
0	0	0	0	0
0	0	0	0	0
0	0	0	0	0
0	0	0	0	0
0	0	1	0	1
0	0	0	0	0
0	0	1	0	1

**AimTD LLC**  
TURNING MOVEMENT COUNTS

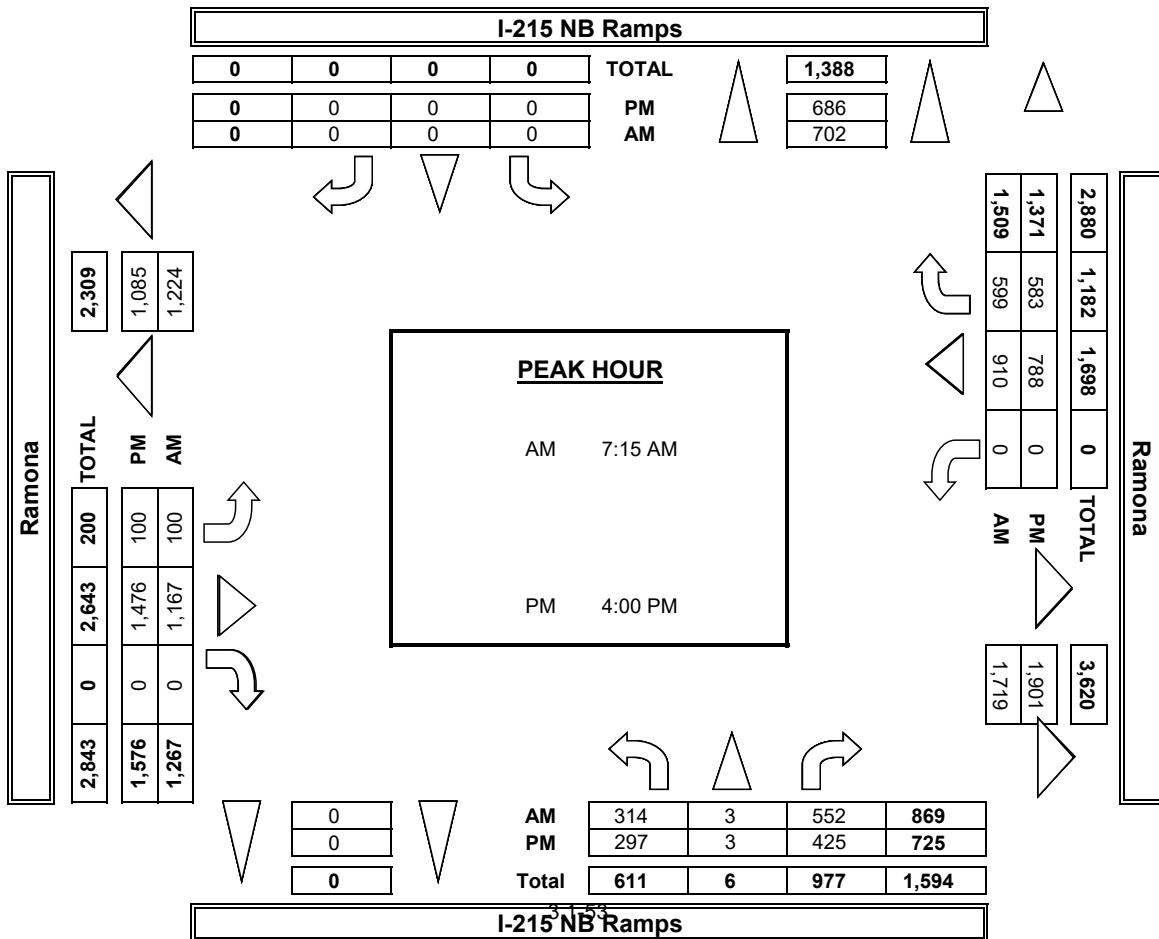
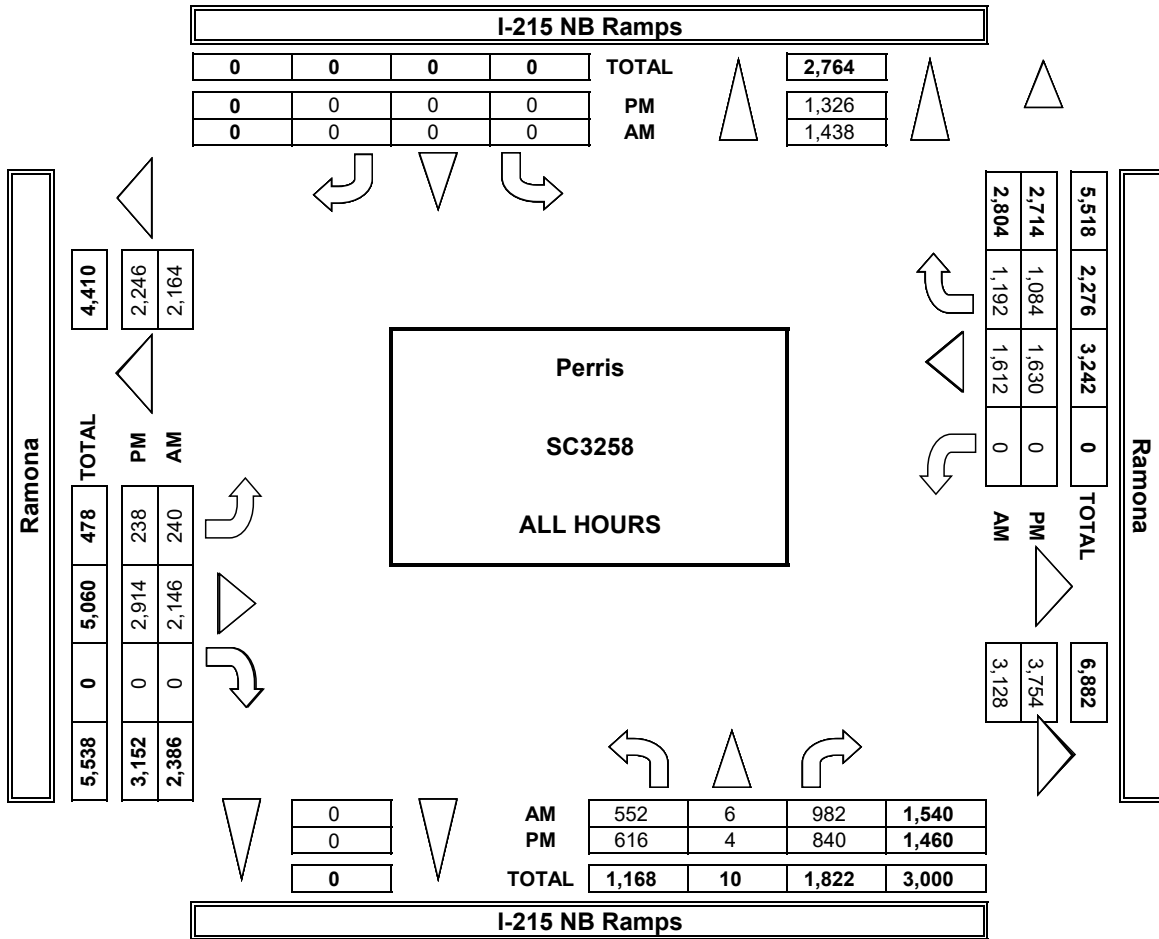

### INTERSECTION TURNING MOVEMENT COUNTS

PREPARED BY: AimTD LLC. tel: 714 253 7888 cs@aimtd.com

DATE: 1/25/22 TUESDAY	LOCATION: NORTH & SOUTH: EAST & WEST:	Perris I-215 NB Ramps Ramona	PROJECT #: LOCATION #: CONTROL:	SC3258 2 SIGNAL
-----------------------------	---	------------------------------------	---------------------------------------	-----------------------

<b>CLASS 2:</b> 2-AXLE WORK VEHICLES/ TRUCKS	<b>NOTES:</b>	AM		▲		
		PM	← W	N	E ▶	
		MD		▼		
		OTHER				
		OTHER				

LANES:	NORTHBOUND			SOUTHBOUND			EASTBOUND			WESTBOUND			TOTAL
	I-215 NB Ramps			I-215 NB Ramps			Ramona			Ramona			
	NL	NT	NR	SL	ST	SR	EL	ET	ER	WL	WT	WR	
	1.5	0.5	1	X	X	X	1	2	X	X	2	1	

U-TURNS				
NB	SB	EB	WB	TTL
0	0	0	0	0

RTOR			
NRR	SRR	ERR	WRR
0	X	X	0

<b>AM</b>	7:00 AM	7	0	5	0	0	0	1	53	0	0	18	11	95
	7:15 AM	10	0	1	0	0	0	4	27	0	0	26	19	87
	7:30 AM	7	0	6	0	0	0	0	31	0	0	26	14	84
	7:45 AM	8	1	5	0	0	0	5	31	0	0	21	10	81
	8:00 AM	8	0	10	0	0	0	2	28	0	0	24	9	81
	8:15 AM	8	1	5	0	0	0	3	21	0	0	20	8	66
	8:30 AM	7	0	7	0	0	0	5	27	0	0	11	11	68
	8:45 AM	7	0	8	0	0	0	5	17	0	0	21	11	69
	VOLUMES	62	2	47	0	0	0	25	235	0	0	167	93	631
	APPROACH %	56%	2%	42%	0%	0%	0%	10%	90%	0%	0%	64%	36%	
APP/DEPART	111	/	120	0	/	0	260	/	282	260	/	229	0	
BEGIN PEAK HR	7:15 AM													
VOLUMES	33	1	22	0	0	0	11	117	0	0	97	52	333	
APPROACH %	59%	2%	39%	0%	0%	0%	9%	91%	0%	0%	65%	35%		
PEAK HR FACTOR	0.778			0.000			0.889			0.828			0.957	
APP/DEPART	56	/	64	0	/	0	128	/	139	149	/	130	0	
<b>PM</b>	4:00 PM	7	1	4	0	0	0	0	26	0	0	11	9	58
	4:15 PM	9	1	13	0	0	0	1	24	0	0	7	7	62
	4:30 PM	13	0	6	0	0	0	2	26	0	0	10	8	65
	4:45 PM	4	0	8	0	0	0	1	23	0	0	4	8	48
	5:00 PM	3	0	4	0	0	0	3	24	0	0	9	0	43
	5:15 PM	4	0	5	0	0	0	2	18	0	0	17	0	46
	5:30 PM	2	0	3	0	0	0	3	15	0	0	12	4	39
	5:45 PM	5	0	1	0	0	0	1	22	0	0	5	2	36
	VOLUMES	47	2	44	0	0	0	13	178	0	0	75	38	397
	APPROACH %	51%	2%	47%	0%	0%	0%	7%	93%	0%	0%	66%	34%	
APP/DEPART	93	/	53	0	/	0	191	/	222	113	/	122	0	
BEGIN PEAK HR	4:00 PM													
VOLUMES	33	2	31	0	0	0	4	99	0	0	32	32	233	
APPROACH %	50%	3%	47%	0%	0%	0%	4%	96%	0%	0%	50%	50%		
PEAK HR FACTOR	0.717			0.000			0.920			0.800			0.896	
APP/DEPART	66	/	38	0	/	0	103	/	130	64	/	65	0	

0	0	0	0	0
0	0	0	0	0
0	0	0	0	0
0	0	0	0	0
0	0	0	0	0
0	0	0	0	0
0	0	0	0	0
0	0	0	0	0
0	0	0	0	0
0	0	0	0	0

1	0	0	2
1	0	0	6
3	0	0	3
2	0	0	2
5	0	0	1
0	0	0	4
1	0	0	1
4	0	0	3
17	0	0	22

11	0	0	12
----	---	---	----

0	0	0	0	0
0	0	0	0	0
0	0	0	0	0
0	0	0	0	0
0	0	0	0	0
0	0	0	0	0
0	0	0	0	0
0	0	0	0	0
0	0	0	0	0
0	0	0	0	0

0	0	0	3
1	0	0	0
4	0	0	0
4	0	0	1
1	0	0	0
1	0	0	0
1	0	0	1
0	0	0	0
12	0	0	5

9	0	0	4
---	---	---	---

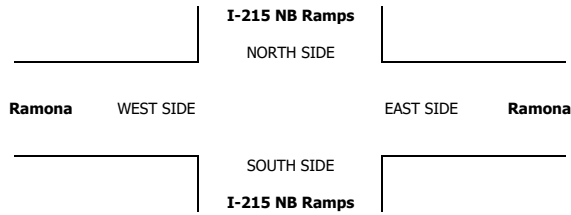

### INTERSECTION TURNING MOVEMENT COUNTS

PREPARED BY: AimTD LLC. tel: 714 253 7888 cs@aimtd.com

DATE: 1/25/22 TUESDAY	LOCATION: NORTH & SOUTH: EAST & WEST:	Perris I-215 NB Ramps Ramona	PROJECT #: LOCATION #: CONTROL:	SC3258 2 SIGNAL
-----------------------------	---	------------------------------------	---------------------------------------	-----------------------

<b>CLASS 3:</b> 3-AXLE TRUCKS	<b>NOTES:</b>	AM PM MD OTHER	◀ W S ▶	▲ N ▼	E ▶
-------------------------------------	---------------	-------------------------	---------------	----------	-----

LANES:	NORTHBOUND <small>I-215 NB Ramps</small>			SOUTHBOUND <small>I-215 NB Ramps</small>			EASTBOUND <small>Ramona</small>			WESTBOUND <small>Ramona</small>			TOTAL
	NL 1.5	NT 0.5	NR 1	SL X	ST X	SR X	EL 1	ET 2	ER X	WL X	WT 2	WR 1	

	NORTHBOUND			SOUTHBOUND			EASTBOUND			WESTBOUND			TOTAL
	NL	NT	NR	SL	ST	SR	EL	ET	ER	WL	WT	WR	
<b>AM</b>													
7:00 AM	0	0	2	0	0	0	5	9	0	0	1	1	18
7:15 AM	5	0	1	0	0	0	9	13	0	0	7	0	35
7:30 AM	2	0	3	0	0	0	5	3	0	0	0	5	18
7:45 AM	2	0	1	0	0	0	2	5	0	0	2	2	14
8:00 AM	4	0	0	0	0	0	3	6	0	0	3	2	18
8:15 AM	1	0	1	0	0	0	3	6	0	0	8	5	24
8:30 AM	0	0	0	0	0	0	5	5	0	0	0	6	16
8:45 AM	1	0	1	0	0	0	7	6	0	0	4	1	20
VOLUMES	15	0	9	0	0	0	39	53	0	0	25	22	163
APPROACH %	63%	0%	38%	0%	0%	0%	42%	58%	0%	0%	53%	47%	
APP/DEPART	24	/	61	0	/	0	92	/	62	47	/	40	0
BEGIN PEAK HR	7:15 AM												
VOLUMES	13	0	5	0	0	0	19	27	0	0	12	9	85
APPROACH %	72%	0%	28%	0%	0%	0%	41%	59%	0%	0%	57%	43%	
PEAK HR FACTOR	0.750			0.000			0.523			0.750			0.607
APP/DEPART	18	/	28	0	/	0	46	/	32	21	/	25	0
<b>PM</b>													
4:00 PM	0	0	3	0	0	0	3	2	0	0	2	0	10
4:15 PM	1	0	1	0	0	0	1	6	0	0	1	1	11
4:30 PM	0	0	2	0	0	0	2	7	0	0	0	1	12
4:45 PM	2	0	2	0	0	0	3	4	0	0	2	3	16
5:00 PM	1	0	1	0	0	0	1	2	0	0	1	1	7
5:15 PM	2	0	0	0	0	0	0	2	0	0	1	1	6
5:30 PM	2	0	0	0	0	0	1	1	0	0	3	0	7
5:45 PM	0	0	1	0	0	0	0	2	0	0	4	3	10
VOLUMES	8	0	10	0	0	0	11	26	0	0	14	10	79
APPROACH %	44%	0%	56%	0%	0%	0%	30%	70%	0%	0%	58%	42%	
APP/DEPART	18	/	21	0	/	0	37	/	36	24	/	22	0
BEGIN PEAK HR	4:00 PM												
VOLUMES	3	0	8	0	0	0	9	19	0	0	5	5	49
APPROACH %	27%	0%	73%	0%	0%	0%	32%	68%	0%	0%	50%	50%	
PEAK HR FACTOR	0.688			0.000			0.778			0.500			0.766
APP/DEPART	11	/	14	0	/	0	28	/	27	10	/	8	0

U-TURNS				
NB	SB	EB	WB	TTL
0	0	0	0	0
0	0	0	0	0
0	0	0	0	0
0	0	0	0	0
0	0	0	0	0
0	0	0	0	0
0	0	0	0	0
0	0	0	0	0
0	0	0	0	0
0	0	0	0	0

RTOR			
NRR	SRR	ERR	WRR
0	X	X	0
1	0	0	0
0	0	0	0
0	0	0	0
0	0	0	1
0	0	0	0
0	0	0	2
1	0	0	0
2	0	0	4

0	0	0	1
---	---	---	---

0	0	0	0	0
0	0	0	0	0
0	0	0	0	0
0	0	0	0	0
0	0	0	0	0
0	0	0	0	0
0	0	0	0	0
0	0	0	0	0
0	0	0	0	0
0	0	0	0	0

0	0	0	0
0	0	0	1
0	0	0	0
0	0	0	2
1	0	0	1
0	0	0	1
0	0	0	0
0	0	0	0
1	0	0	5

0	0	0	3
---	---	---	---

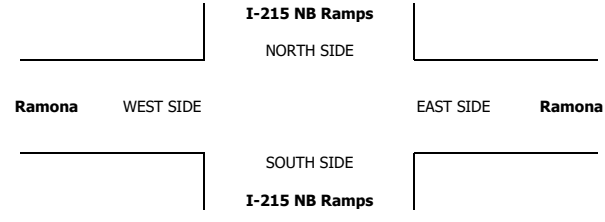

### INTERSECTION TURNING MOVEMENT COUNTS

PREPARED BY: AimTD LLC. tel: 714 253 7888 cs@aimtd.com

DATE: 1/25/22 TUESDAY	LOCATION: NORTH & SOUTH: EAST & WEST:	Perris I-215 NB Ramps Ramona	PROJECT #: LOCATION #: CONTROL:	SC3258 2 SIGNAL
-----------------------------	---	------------------------------------	---------------------------------------	-----------------------

<b>CLASS 4:</b> 4 OR MORE AXLE TRUCKS	<b>NOTES:</b>	<table border="1" style="margin: auto;"> <tr><td>AM</td><td></td><td>▲</td><td></td></tr> <tr><td>PM</td><td></td><td>▲</td><td>N</td></tr> <tr><td>MD</td><td>◀ W</td><td></td><td>E ▶</td></tr> <tr><td>OTHER</td><td></td><td>▼</td><td>S</td></tr> </table>	AM		▲		PM		▲	N	MD	◀ W		E ▶	OTHER		▼	S
AM		▲																
PM		▲	N															
MD	◀ W		E ▶															
OTHER		▼	S															

LANES:	NORTHBOUND			SOUTHBOUND			EASTBOUND			WESTBOUND			TOTAL
	I-215 NB Ramps			I-215 NB Ramps			Ramona			Ramona			
	NL	NT	NR	SL	ST	SR	EL	ET	ER	WL	WT	WR	
	1.5	0.5	1	X	X	X	1	2	X	X	2	1	

U-TURNS				
NB	SB	EB	WB	TTL
0	0	0	0	0

RTOR			
NRR	SRR	ERR	WRR
0	X	X	0

AM	7:00 AM	12	0	8	0	0	0	12	15	0	0	4	10	61
	7:15 AM	7	0	7	0	0	0	3	16	0	0	14	13	60
	7:30 AM	8	0	2	0	0	0	3	21	0	0	11	14	59
	7:45 AM	5	0	5	0	0	0	5	25	0	0	9	10	59
	8:00 AM	7	0	8	0	0	0	6	19	0	0	6	16	62
	8:15 AM	8	0	6	0	0	0	5	25	0	0	9	16	69
	8:30 AM	1	0	4	0	0	0	6	33	0	0	3	11	58
	8:45 AM	9	0	6	0	0	0	8	24	0	0	10	19	76
	VOLUMES	57	0	46	0	0	0	48	178	0	0	66	109	504
	APPROACH %	55%	0%	45%	0%	0%	0%	21%	79%	0%	0%	38%	62%	
APP/DEPART	103	/	157	0	/	0	226	/	224	175	/	123	0	
BEGIN PEAK HR	7:15 AM													
VOLUMES	27	0	22	0	0	0	17	81	0	0	40	53	240	
APPROACH %	55%	0%	45%	0%	0%	0%	17%	83%	0%	0%	43%	57%		
PEAK HR FACTOR	0.817			0.000			0.817			0.861			0.968	
APP/DEPART	49	/	70	0	/	0	98	/	103	93	/	67	0	
PM	4:00 PM	1	0	1	0	0	0	2	11	0	0	4	7	26
	4:15 PM	6	0	2	0	0	0	2	10	0	0	8	7	35
	4:30 PM	6	0	2	0	0	0	0	12	0	0	3	6	29
	4:45 PM	3	0	1	0	0	0	1	13	0	0	4	4	26
	5:00 PM	0	0	1	0	0	0	1	14	0	0	8	7	31
	5:15 PM	5	0	0	0	0	0	4	13	0	0	3	13	38
	5:30 PM	4	0	1	0	0	0	2	7	0	0	4	8	26
	5:45 PM	2	0	1	0	0	0	1	10	0	0	4	4	22
	VOLUMES	27	0	9	0	0	0	13	90	0	0	38	56	233
	APPROACH %	75%	0%	25%	0%	0%	0%	13%	87%	0%	0%	40%	60%	
APP/DEPART	36	/	69	0	/	0	103	/	99	94	/	65	0	
BEGIN PEAK HR	4:00 PM													
VOLUMES	16	0	6	0	0	0	5	46	0	0	19	24	116	
APPROACH %	73%	0%	27%	0%	0%	0%	10%	90%	0%	0%	44%	56%		
PEAK HR FACTOR	0.688			0.000			0.911			0.717			0.829	
APP/DEPART	22	/	29	0	/	0	51	/	52	43	/	35	0	

0	0	0	0	0
0	0	0	0	0
0	0	0	0	0
0	0	0	0	0
0	0	0	0	0
0	0	0	0	0
0	0	0	0	0
0	0	0	0	0
0	0	0	0	0
0	0	0	0	0
0	0	0	0	0

2	0	0	4
1	0	0	2
0	0	0	5
0	0	0	2
4	0	0	2
2	0	0	3
2	0	0	1
1	0	0	4
12	0	0	23

5	0	0	11
---	---	---	----

0	0	0	0	0
0	0	0	0	0
0	0	0	0	0
0	0	0	0	0
0	0	0	0	0
0	0	0	0	0
0	0	0	0	0
0	0	0	0	0
0	0	0	0	0
0	0	0	0	0
0	0	0	0	0

0	0	0	3
0	0	0	0
0	0	0	1
1	0	0	1
1	0	0	1
0	0	0	3
0	0	0	1
0	0	0	0
2	0	0	10

1	0	0	5
---	---	---	---

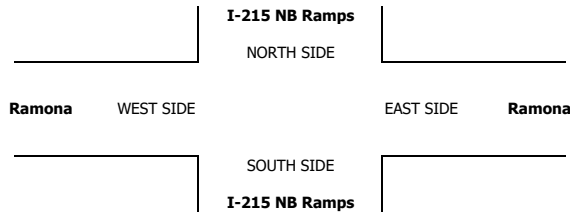



### Counts Unlimited, Inc.

County of Riverside  
 Harvill Avenue  
 B/ Peregrine Way - Exel Worksite Entrance  
 24 Hour Directional Classification Count

PO Box 1178  
 Corona, CA 92878  
 Phone: (951) 268-6268  
 email: counts@countsunlimited.com

CRV002  
 Site Code: 051-22112

Northbound, Southbound

Start Time	Bikes	Cars & Trailers	2 Axle Long	Buses	2 Axle 6 Tire	3 Axle Single	4 Axle Single	<5 Axl Double	5 Axle Double	>6 Axl Double	<6 Axl Multi	6 Axle Multi	>6 Axl Multi	Total
02/08/22	0	47	11	0	0	1	0	1	10	0	0	0	0	70
01:00	1	31	7	0	0	1	0	0	4	0	0	0	0	44
02:00	0	36	4	0	1	1	0	0	0	0	0	0	0	42
03:00	0	64	11	0	2	3	0	0	7	0	0	0	0	87
04:00	0	198	37	0	3	3	0	0	7	0	0	0	0	248
05:00	1	242	38	2	1	7	0	0	8	0	1	0	0	300
06:00	1	306	85	4	12	12	1	2	19	2	0	0	0	444
07:00	1	<b>467</b>	<b>112</b>	5	<b>20</b>	4	0	<b>5</b>	20	0	1	0	0	<b>635</b>
08:00	0	323	82	<b>6</b>	16	6	<b>3</b>	4	24	0	0	0	0	464
09:00	1	203	79	1	13	10	2	1	10	0	0	<b>1</b>	0	321
10:00	0	209	67	0	15	15	2	3	<b>36</b>	1	0	0	0	348
11:00	<b>2</b>	237	71	3	18	<b>16</b>	2	5	20	0	0	0	0	374
12 PM	0	258	90	1	22	16	5	3	28	0	0	<b>2</b>	0	425
13:00	0	417	100	7	18	11	1	6	21	0	<b>2</b>	0	0	583
14:00	<b>3</b>	475	158	5	24	14	4	<b>11</b>	25	0	1	0	0	720
15:00	2	<b>573</b>	<b>167</b>	<b>9</b>	<b>26</b>	<b>17</b>	3	5	<b>35</b>	<b>1</b>	0	0	0	<b>838</b>
16:00	3	478	117	2	16	15	<b>7</b>	0	16	0	0	0	0	654
17:00	2	450	101	2	6	8	2	0	10	0	0	0	<b>1</b>	582
18:00	0	353	46	1	3	3	0	4	11	0	0	0	0	421
19:00	2	231	24	0	3	4	0	3	15	0	0	0	0	282
20:00	1	149	24	0	0	2	0	2	11	0	0	0	0	189
21:00	0	129	22	0	0	2	0	1	11	0	0	0	0	165
22:00	0	105	18	0	1	1	0	0	8	0	0	0	0	133
23:00	0	75	11	0	2	4	0	0	5	0	0	0	0	97
Total	20	6056	1482	48	222	176	32	56	361	4	5	3	1	8466
Percent	0.2%	71.5%	17.5%	0.6%	2.6%	2.1%	0.4%	0.7%	4.3%	0.0%	0.1%	0.0%	0.0%	
AM Peak	11:00	07:00	07:00	08:00	07:00	11:00	08:00	07:00	10:00	06:00	05:00	09:00		07:00
Vol.	2	467	112	6	20	16	3	5	36	2	1	1		635
PM Peak	14:00	15:00	15:00	15:00	15:00	15:00	16:00	14:00	15:00	15:00	13:00	12:00	17:00	15:00
Vol.	3	573	167	9	26	17	7	11	35	1	2	2	1	838
Grand Total	20	6056	1482	48	222	176	32	56	361	4	5	3	1	8466
Percent	0.2%	71.5%	17.5%	0.6%	2.6%	2.1%	0.4%	0.7%	4.3%	0.0%	0.1%	0.0%	0.0%	

**24-HOUR ROADWAY SEGMENT COUNTS (WITH FHWA CLASSIFICATION)**

PREPARED BY: AimTD LLC. tel: 714 253 7888 cs@aimtd.com

DATE: Tuesday, May 10, 2022  
JOB #: SC3419

CITY: Perris  
LOCATION: CLASS2 Harvill N of Cajalco

AM TIME	NORTHBOUND													TOTAL	PM Time	NORTHBOUND													TOTAL
	1	2	3	4	5	6	7	8	9	10	11	12	13			1	2	3	4	5	6	7	8	9	10	11	12	13	
0:00	0	5	0	0	0	0	0	0	0	0	0	0	0	5	12:00	1	74	6	0	0	2	0	0	5	0	0	0	88	
0:15	0	5	0	0	0	0	0	0	0	0	0	0	0	5	12:15	0	54	3	0	2	2	0	0	3	0	2	0	66	
0:30	0	17	0	0	0	0	0	0	1	0	0	0	0	18	12:30	0	54	5	1	2	2	0	0	6	0	2	0	72	
0:45	0	5	0	0	0	0	0	0	0	0	0	0	0	5	12:45	1	51	5	0	8	5	0	0	4	0	0	74		
1:00	1	6	0	0	0	0	0	0	2	0	0	0	0	9	13:00	0	43	4	0	2	4	0	0	4	0	1	0	58	
1:15	0	4	0	0	0	0	0	0	2	0	0	0	0	6	13:15	0	55	1	1	1	3	0	0	6	0	0	0	67	
1:30	0	4	0	0	0	0	0	0	1	0	0	0	0	5	13:30	0	105	7	0	0	2	0	0	3	0	1	0	118	
1:45	0	5	0	0	0	0	0	0	2	0	0	0	0	7	13:45	1	89	5	0	5	0	0	0	5	0	1	0	106	
2:00	0	3	0	0	0	1	0	0	3	0	0	0	0	7	14:00	0	85	4	0	2	1	0	0	2	0	0	0	94	
2:15	0	2	0	0	0	0	0	0	1	0	0	0	0	3	14:15	0	85	4	0	1	2	0	1	3	0	3	0	99	
2:30	0	4	0	0	0	0	0	0	0	0	0	0	0	4	14:30	1	162	9	0	1	1	0	0	4	0	0	0	178	
2:45	0	3	0	0	0	0	0	0	1	0	0	0	0	4	14:45	0	105	3	0	4	1	1	0	2	0	0	0	116	
3:00	0	6	0	0	0	1	0	0	2	0	0	0	0	9	15:00	0	99	3	0	1	0	0	0	1	0	1	0	105	
3:15	1	8	1	0	0	0	0	0	0	0	0	0	0	10	15:15	0	113	7	0	2	3	0	0	1	0	0	0	126	
3:30	0	14	0	0	0	1	0	0	1	0	0	0	0	16	15:30	0	120	10	0	2	0	0	0	2	0	0	0	134	
3:45	0	12	0	0	0	0	0	0	1	0	0	0	0	13	15:45	0	101	5	1	3	0	1	0	3	0	0	0	114	
4:00	0	18	0	0	1	0	0	0	2	0	0	0	0	21	16:00	0	96	8	0	0	2	1	0	2	0	2	0	111	
4:15	0	28	0	0	0	0	0	0	0	0	0	0	0	28	16:15	0	84	6	0	0	3	0	0	3	0	0	0	96	
4:30	0	21	0	0	2	1	0	0	6	0	0	0	0	30	16:30	0	92	8	2	1	1	0	0	0	0	0	0	104	
4:45	0	23	1	0	2	0	0	0	1	0	0	0	0	27	16:45	0	76	4	0	1	0	1	0	1	0	0	0	83	
5:00	0	27	0	0	1	0	0	0	4	0	0	0	0	32	17:00	1	63	5	0	0	1	0	0	3	0	0	0	73	
5:15	1	42	2	0	1	1	0	0	3	0	0	0	0	50	17:15	1	69	4	0	0	0	0	0	0	0	0	0	74	
5:30	1	53	3	0	3	1	0	0	5	0	0	0	0	66	17:30	0	69	2	0	1	1	0	0	1	0	0	0	74	
5:45	0	46	3	1	2	1	0	0	5	0	0	0	0	58	17:45	0	49	3	0	0	0	0	0	0	0	0	0	52	
6:00	0	50	6	3	5	0	0	0	1	0	0	0	0	65	18:00	0	56	4	0	0	0	0	0	2	0	0	0	62	
6:15	0	70	6	2	1	2	0	0	0	0	1	0	0	82	18:15	0	62	1	0	0	2	0	0	0	0	0	0	65	
6:30	0	117	9	1	3	1	0	0	3	0	0	0	0	134	18:30	0	58	1	0	0	0	0	0	2	0	0	0	61	
6:45	0	172	12	2	4	1	0	0	2	0	1	0	0	194	18:45	1	48	2	0	0	1	0	0	1	0	0	0	53	
7:00	0	164	4	0	5	1	1	0	4	0	1	0	0	180	19:00	0	40	2	0	0	1	0	0	3	0	0	0	46	
7:15	0	170	7	0	7	0	1	0	3	0	0	0	0	188	19:15	0	40	3	0	0	3	0	0	1	0	1	0	48	
7:30	0	161	12	0	6	1	0	0	3	0	0	1	0	184	19:30	0	37	0	0	0	0	0	0	1	0	0	0	38	
7:45	0	141	8	0	4	1	0	0	5	0	3	0	0	162	19:45	2	30	0	0	0	0	0	1	2	0	0	0	35	
8:00	0	123	5	0	2	1	0	0	5	0	0	0	0	136	20:00	0	31	0	0	0	0	0	1	0	0	0	0	32	
8:15	0	86	2	0	5	2	0	0	5	0	1	0	0	101	20:15	1	48	0	0	0	0	1	0	1	0	0	0	51	
8:30	0	57	5	0	2	0	0	0	2	0	1	0	0	67	20:30	0	29	1	0	0	0	0	0	1	0	0	0	31	
8:45	0	50	3	0	1	0	0	0	6	0	1	1	0	62	20:45	0	39	0	0	0	0	0	0	0	0	0	0	39	
9:00	0	60	8	0	1	0	0	0	5	0	0	0	0	74	21:00	0	36	1	0	0	0	0	0	1	0	0	0	38	
9:15	0	38	1	0	6	2	0	0	1	0	1	0	0	49	21:15	0	23	0	0	0	0	0	0	0	0	0	0	23	
9:30	0	36	9	0	1	3	0	0	2	0	0	0	0	51	21:30	0	15	0	0	0	0	0	0	1	0	0	0	16	
9:45	0	49	6	0	5	0	1	0	4	0	0	0	0	65	21:45	0	27	1	0	0	0	0	0	0	0	0	0	28	
10:00	1	55	4	0	2	1	0	0	4	0	0	0	0	67	22:00	0	24	1	0	0	0	0	0	0	0	0	0	25	
10:15	0	45	1	0	2	1	0	0	6	0	0	0	0	55	22:15	0	14	0	0	0	3	0	0	0	0	0	0	17	
10:30	0	52	5	0	1	1	0	0	12	0	0	0	0	71	22:30	0	18	0	0	0	0	0	0	1	0	0	0	19	
10:45	0	41	1	0	1	2	0	0	5	0	1	0	0	51	22:45	0	13	0	0	0	0	0	0	0	0	0	0	13	
11:00	1	65	7	0	2	2	0	0	7	0	0	0	0	84	23:00	0	14	0	0	0	0	0	0	0	0	0	0	14	
11:15	0	50	4	0	2	1	0	0	4	0	1	0	0	62	23:15	0	13	0	0	0	0	0	0	0	0	0	0	13	
11:30	0	50	5	0	2	3	0	0	4	0	0	0	0	64	23:30	0	11	0	0	0	0	0	0	0	0	0	0	11	
11:45	0	45	6	1	6	1	0	0	2	0	0	0	0	61	23:45	0	5	0	0	0	0	0	0	0	0	0	0	5	
<b>TOTAL</b>	<b>6</b>	<b>2,308</b>	<b>146</b>	<b>10</b>	<b>88</b>	<b>34</b>	<b>3</b>	<b>0</b>	<b>138</b>	<b>0</b>	<b>13</b>	<b>1</b>	<b>0</b>	<b>2,747</b>	<b>TOTAL</b>	<b>10</b>	<b>2,724</b>	<b>138</b>	<b>5</b>	<b>39</b>	<b>46</b>	<b>5</b>	<b>3</b>	<b>81</b>	<b>0</b>	<b>14</b>	<b>0</b>	<b>0</b>	<b>3,065</b>

AM PEAK HOUR 6:45 AM  
AM PEAK VOLUME 746

PM PEAK HOUR 2:30 PM  
PM PEAK VOLUME 525

<b>CLASS 1</b>	Class 1 — Motorcycles	<b>CLASS 8</b>	3 to 4 Axles, Single Trailer
<b>CLASS 2</b>	Passenger Cars	<b>CLASS 9</b>	5 Axles, Single Trailer
<b>CLASS 3</b>	2 Axles, 4-Tire Single Units	<b>CLASS 10</b>	6 or More Axles, Single Trailer
<b>CLASS 4</b>	Buses	<b>CLASS 11</b>	5 or Less Axles, Multi-Trailers
<b>CLASS 5</b>	2 Axles, 6-Tire Single Units	<b>CLASS 12</b>	6 Axles, Multi-Trailers
<b>CLASS 6</b>	3 Axles, Single Unit	<b>CLASS 13</b>	7 or More Axles, Multi-Trailers
<b>CLASS 7</b>	4 or More Axles, Single Unit		

<b>TOTAL: AM+PM</b>	16	5,032	284	15	127	80	8	3	219	0	27	1	0	5,812
<b>% OF TOTAL</b>	0.3%	86.6%	4.9%	0.3%	2.2%	1.4%	0.1%	0.1%	3.8%	0.0%	0.5%	0.0%	0.0%	100.0%

<b>Class</b>	<b>1</b>	<b>2</b>	<b>3</b>	<b>4</b>	<b>5</b>	<b>6</b>	<b>7</b>	<b>8</b>	<b>9</b>	<b>10</b>	<b>11</b>	<b>12</b>	<b>13</b>	
<b>TOTAL: ALL</b>	29	9,355	525	30	247	151	17	7	457	1	49	1	0	10,869
<b>% OF TOTAL</b>	0.5%	161.0%	9.0%	0.5%	4.2%	2.6%	0.3%	0.1%	7.9%	0.0%	0.8%	0.0%	0.0%	100.0%

**24-HOUR ROADWAY SEGMENT COUNTS (WITH FHWA CLASSIFICATION)**

PREPARED BY: AimTD LLC. tel: 714 253 7888 cs@aimtd.com

DATE: Tuesday, May 10, 2022  
JOB #: SC3419

CITY: Perris  
LOCATION: CLASS2 Harvill N of Cajalco

AM TIME	SOUTHBOUND													TOTAL	PM Time	SOUTHBOUND													TOTAL
	1	2	3	4	5	6	7	8	9	10	11	12	13			1	2	3	4	5	6	7	8	9	10	11	12	13	
0:00	0	7	0	0	0	0	0	0	0	0	0	0	0	7	12:00	0	56	4	0	2	3	0	0	6	0	0	0	71	
0:15	0	3	0	0	0	0	0	0	0	0	0	0	0	3	12:15	0	58	9	0	0	1	0	0	11	0	0	0	79	
0:30	0	9	0	0	0	1	0	0	0	0	0	0	0	10	12:30	0	58	5	0	2	2	0	0	8	0	0	0	75	
0:45	0	7	0	0	0	0	0	0	0	0	0	0	0	7	12:45	1	70	4	0	1	1	0	0	9	0	0	0	86	
1:00	1	4	0	0	0	0	0	0	0	0	0	0	0	5	13:00	2	53	3	0	1	0	0	0	3	0	2	0	64	
1:15	0	3	0	0	0	0	0	0	0	0	0	0	0	3	13:15	0	46	2	0	3	0	0	0	3	0	0	0	54	
1:30	0	4	0	0	0	0	0	0	0	0	0	0	0	4	13:30	1	58	2	0	1	2	1	0	4	0	0	0	69	
1:45	0	10	0	0	0	0	1	0	0	0	0	0	0	11	13:45	0	59	4	0	2	1	0	0	4	0	1	0	71	
2:00	0	10	0	0	0	0	0	0	1	0	0	0	0	11	14:00	0	88	10	0	3	1	0	0	6	0	1	0	109	
2:15	0	5	0	0	0	0	0	0	0	0	0	0	0	5	14:15	1	93	5	1	2	3	0	0	5	0	1	0	111	
2:30	0	3	0	0	0	0	0	0	0	0	0	0	0	3	14:30	0	118	8	0	6	2	0	0	3	0	0	0	137	
2:45	0	2	0	0	0	1	0	0	0	0	0	0	0	3	14:45	0	134	6	0	6	2	1	0	4	0	2	0	155	
3:00	0	2	0	0	0	0	0	0	0	0	0	0	0	2	15:00	0	120	7	1	4	2	1	0	3	0	1	0	139	
3:15	0	9	0	0	0	1	0	0	1	0	0	0	0	11	15:15	0	102	12	0	4	1	1	1	2	0	3	0	126	
3:30	0	8	1	0	1	0	0	0	0	0	0	0	0	10	15:30	0	94	3	1	2	1	0	0	2	0	0	0	103	
3:45	0	6	0	0	0	0	0	0	1	0	0	0	0	7	15:45	0	92	8	2	3	0	0	1	9	0	0	0	115	
4:00	0	10	1	0	0	1	0	0	0	0	0	0	0	12	16:00	0	73	7	1	1	1	0	0	4	0	0	0	87	
4:15	0	16	0	0	0	0	0	0	2	0	0	0	0	18	16:15	0	109	8	0	1	2	0	0	2	0	0	0	122	
4:30	0	27	0	0	0	0	0	0	0	0	0	0	0	27	16:30	0	98	6	1	2	0	0	0	4	0	0	0	111	
4:45	0	49	1	0	1	1	0	0	0	0	0	0	0	52	16:45	0	103	13	1	1	0	1	0	3	0	0	0	122	
5:00	0	34	0	0	0	0	0	0	0	0	0	0	0	34	17:00	0	93	3	1	3	0	0	0	1	0	0	0	101	
5:15	0	34	0	0	0	3	0	0	0	0	0	0	0	37	17:15	0	86	4	1	0	1	0	0	1	0	0	0	93	
5:30	0	45	0	0	2	0	0	0	0	0	0	0	0	47	17:30	0	85	4	1	0	0	0	0	2	0	1	0	93	
5:45	0	99	3	0	2	1	0	0	1	0	0	0	0	106	17:45	0	67	3	0	1	1	0	0	3	0	0	0	75	
6:00	0	44	1	0	0	0	0	0	0	0	0	0	0	45	18:00	0	78	6	0	1	0	0	0	3	0	0	0	88	
6:15	0	32	1	0	2	1	0	0	0	0	1	0	0	37	18:15	0	63	1	0	0	1	0	1	4	0	0	0	70	
6:30	0	40	3	0	1	0	1	0	4	0	2	0	0	51	18:30	0	64	3	0	0	0	0	0	4	0	0	0	71	
6:45	0	48	2	0	0	0	1	0	6	0	2	0	0	59	18:45	0	68	2	0	0	2	0	0	6	0	0	0	78	
7:00	0	36	3	0	1	0	0	0	6	0	0	0	0	46	19:00	0	69	1	0	1	0	0	0	3	0	0	0	74	
7:15	0	46	3	0	1	1	0	0	1	1	0	0	0	53	19:15	1	33	1	0	0	1	0	0	4	0	0	0	40	
7:30	1	55	4	0	2	3	1	0	4	0	0	0	0	70	19:30	0	31	0	0	1	0	0	0	5	0	0	0	37	
7:45	0	65	3	0	4	0	0	0	2	0	0	0	0	74	19:45	0	36	0	0	1	0	0	0	2	0	0	0	39	
8:00	0	82	4	0	3	0	0	0	4	0	0	0	0	93	20:00	3	36	1	0	0	0	0	0	0	0	0	0	40	
8:15	0	56	1	0	4	1	0	0	0	0	2	0	0	64	20:15	0	30	0	0	0	0	0	0	0	0	0	0	30	
8:30	1	66	5	1	4	1	0	0	4	0	0	0	0	82	20:30	0	28	0	0	0	1	0	0	3	0	0	0	32	
8:45	0	42	3	2	2	0	0	0	2	0	1	0	0	52	20:45	0	33	0	0	1	0	0	0	0	0	0	0	34	
9:00	0	37	2	1	1	0	0	0	2	0	0	0	0	43	21:00	0	23	0	0	0	0	0	0	2	0	0	0	25	
9:15	1	41	6	0	4	3	0	0	5	0	0	0	0	60	21:15	0	29	1	0	0	1	0	0	0	0	0	0	31	
9:30	0	35	6	0	0	2	0	0	8	0	0	0	0	51	21:30	0	22	0	0	0	0	0	0	0	0	0	0	22	
9:45	0	47	4	0	1	2	0	0	5	0	0	0	0	59	21:45	0	18	0	0	0	0	0	0	0	0	0	0	18	
10:00	0	48	5	0	3	2	0	0	5	0	1	0	0	64	22:00	0	21	0	0	0	1	0	0	0	0	0	0	22	
10:15	0	38	2	0	2	3	0	0	8	0	0	0	0	53	22:15	0	16	0	0	0	0	0	0	1	0	0	0	17	
10:30	0	46	2	0	2	0	0	1	6	0	0	0	0	57	22:30	0	20	0	0	0	0	0	0	1	0	0	0	21	
10:45	0	44	6	0	2	2	0	0	6	0	0	0	0	60	22:45	0	12	0	0	1	0	0	0	0	0	0	0	13	
11:00	0	46	5	0	0	1	0	0	4	0	0	0	0	56	23:00	0	10	0	0	0	0	0	0	1	0	0	0	11	
11:15	0	43	3	0	9	1	0	0	2	0	0	0	0	58	23:15	0	14	0	0	1	1	0	0	1	0	0	0	17	
11:30	0	50	4	0	5	2	0	0	3	0	0	0	0	64	23:30	0	15	0	0	1	1	0	0	0	0	0	0	17	
11:45	0	44	1	0	2	1	0	0	3	0	1	0	0	52	23:45	0	4	0	0	0	0	0	0	0	0	0	0	4	
<b>TOTAL</b>	<b>4</b>	<b>1,537</b>	<b>85</b>	<b>4</b>	<b>61</b>	<b>35</b>	<b>4</b>	<b>1</b>	<b>96</b>	<b>1</b>	<b>10</b>	<b>0</b>	<b>0</b>	<b>1,838</b>	<b>TOTAL</b>	<b>9</b>	<b>2,786</b>	<b>156</b>	<b>11</b>	<b>59</b>	<b>36</b>	<b>5</b>	<b>3</b>	<b>142</b>	<b>0</b>	<b>12</b>	<b>0</b>	<b>0</b>	<b>3,219</b>

**AM PEAK HOUR** 7:45 AM  
**AM PEAK VOLUME** 313

**PM PEAK HOUR** 2:30 PM  
**PM PEAK VOLUME** 557

<b>CLASS 1</b>	Class 1 — Motorcycles	<b>CLASS 8</b>	3 to 4 Axles, Single Trailer
<b>CLASS 2</b>	Passenger Cars	<b>CLASS 9</b>	5 Axles, Single Trailer
<b>CLASS 3</b>	2 Axles, 4-Tire Single Units	<b>CLASS 10</b>	6 or More Axles, Single Trailer
<b>CLASS 4</b>	Buses	<b>CLASS 11</b>	5 or Less Axles, Multi-Trailers
<b>CLASS 5</b>	2 Axles, 6-Tire Single Units	<b>CLASS 12</b>	6 Axles, Multi-Trailers
<b>CLASS 6</b>	3 Axles, Single Unit	<b>CLASS 13</b>	7 or More Axles, Multi-Trailers
<b>CLASS 7</b>	4 or More Axles, Single Unit		

<b>TOTAL: AM+PM</b>	13	4,323	241	15	120	71	9	4	238	1	22	0	0	5,057
<b>% OF TOTAL</b>	0.3%	85.5%	4.8%	0.3%	2.4%	1.4%	0.2%	0.1%	4.7%	0.0%	0.4%	0.0%	0.0%	100.0%

<b>Class</b>	<b>1</b>	<b>2</b>	<b>3</b>	<b>4</b>	<b>5</b>	<b>6</b>	<b>7</b>	<b>8</b>	<b>9</b>	<b>10</b>	<b>11</b>	<b>12</b>	<b>13</b>
--------------	----------	----------	----------	----------	----------	----------	----------	----------	----------	-----------	-----------	-----------	-----------

This Page Intentionally Left Blank

**APPENDIX 3.2: EXISTING (2022) CONDITIONS INTERSECTION  
OPERATIONS ANALYSIS WORKSHEETS**

This Page Intentionally Left Blank

Intersection						
Int Delay, s/veh	0					
Movement	WBL	WBR	NBT	NBR	SBL	SBT
Lane Configurations	↵	↶	↕↗		↵	↕↗
Traffic Vol, veh/h	0	0	451	0	3	273
Future Vol, veh/h	0	0	451	0	3	273
Conflicting Peds, #/hr	0	0	0	0	0	0
Sign Control	Stop	Stop	Free	Free	Free	Free
RT Channelized	-	None	-	None	-	None
Storage Length	0	0	-	-	130	-
Veh in Median Storage, #	1	-	0	-	-	0
Grade, %	0	-	0	-	-	0
Peak Hour Factor	94	94	94	94	94	94
Heavy Vehicles, %	0	0	0	0	0	0
Mvmt Flow	0	0	480	0	3	290

Major/Minor	Minor1	Major1	Major2		
Conflicting Flow All	631	240	0	0	480
Stage 1	480	-	-	-	-
Stage 2	151	-	-	-	-
Critical Hdwy	6.8	6.9	-	-	4.1
Critical Hdwy Stg 1	5.8	-	-	-	-
Critical Hdwy Stg 2	5.8	-	-	-	-
Follow-up Hdwy	3.5	3.3	-	-	2.2
Pot Cap-1 Maneuver	418	767	-	-	1093
Stage 1	594	-	-	-	-
Stage 2	867	-	-	-	-
Platoon blocked, %			-	-	-
Mov Cap-1 Maneuver	417	767	-	-	1093
Mov Cap-2 Maneuver	496	-	-	-	-
Stage 1	594	-	-	-	-
Stage 2	864	-	-	-	-

Approach	WB	NB	SB
HCM Control Delay, s	0	0	0.1
HCM LOS	A		

Minor Lane/Major Mvmt	NBT	NBRWBLn1WBLn2	SBL	SBT
Capacity (veh/h)	-	-	-	1093
HCM Lane V/C Ratio	-	-	-	0.003
HCM Control Delay (s)	-	-	0	8.3
HCM Lane LOS	-	-	A	A
HCM 95th %tile Q(veh)	-	-	-	0

Timings  
3: Harvill Av. & Cajalco Exwy./Ramona Exwy.

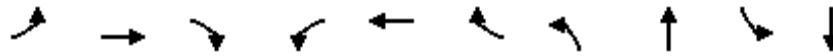

Lane Group	EBL	EBT	EBR	WBL	WBT	WBR	NBL	NBT	SBL	SBT
Lane Configurations	↘	↑↑	↗	↘↗	↑↑	↗	↘↗	↑↔	↘↗	↑↔
Traffic Volume (vph)	47	680	50	167	677	102	297	337	189	116
Future Volume (vph)	47	680	50	167	677	102	297	337	189	116
Turn Type	Prot	NA	Perm	Prot	NA	pm+ov	Prot	NA	Prot	NA
Protected Phases	5	2		1	6	7	3	8	7	4
Permitted Phases			2			6				
Detector Phase	5	2	2	1	6	7	3	8	7	4
Switch Phase										
Minimum Initial (s)	5.0	10.0	10.0	5.0	10.0	5.0	5.0	10.0	5.0	10.0
Minimum Split (s)	9.6	36.2	36.2	9.6	32.5	9.6	9.6	16.2	9.6	41.2
Total Split (s)	10.2	38.8	38.8	16.7	45.3	15.6	23.3	48.9	15.6	41.2
Total Split (%)	8.5%	32.3%	32.3%	13.9%	37.8%	13.0%	19.4%	40.8%	13.0%	34.3%
Yellow Time (s)	3.6	5.2	5.2	3.6	3.5	3.6	3.6	5.2	3.6	5.2
All-Red Time (s)	1.0	1.0	1.0	1.0	1.0	1.0	1.0	1.0	1.0	1.0
Lost Time Adjust (s)	0.0	0.0	0.0	0.0	0.0	0.0	0.0	0.0	0.0	0.0
Total Lost Time (s)	4.6	6.2	6.2	4.6	4.5	4.6	4.6	6.2	4.6	6.2
Lead/Lag	Lead	Lag	Lag	Lead	Lag	Lead	Lead	Lag	Lead	Lag
Lead-Lag Optimize?	Yes	Yes	Yes	Yes	Yes	Yes	Yes	Yes	Yes	Yes
Recall Mode	None	None	None	None	None	None	None	Max	None	Max
Act Effct Green (s)	5.5	27.8	27.8	9.9	36.1	50.6	14.5	42.9	9.9	38.4
Actuated g/C Ratio	0.05	0.25	0.25	0.09	0.32	0.45	0.13	0.38	0.09	0.34
v/c Ratio	0.58	0.82	0.10	0.58	0.63	0.14	0.71	0.33	0.66	0.13
Control Delay	80.7	48.2	0.4	58.3	35.5	3.6	56.6	25.0	61.5	24.0
Queue Delay	0.0	0.0	0.0	0.0	0.0	0.0	0.0	0.0	0.0	0.0
Total Delay	80.7	48.2	0.4	58.3	35.5	3.6	56.6	25.0	61.5	24.0
LOS	F	D	A	E	D	A	E	C	E	C
Approach Delay		47.1			36.1			38.2		45.3
Approach LOS		D			D			D		D

Intersection Summary

Cycle Length: 120  
 Actuated Cycle Length: 112.3  
 Natural Cycle: 100  
 Control Type: Actuated-Uncoordinated  
 Maximum v/c Ratio: 0.82  
 Intersection Signal Delay: 40.8  
 Intersection LOS: D  
 Intersection Capacity Utilization 58.7%  
 ICU Level of Service B  
 Analysis Period (min) 15

Splits and Phases: 3: Harvill Av. & Cajalco Exwy./Ramona Exwy.

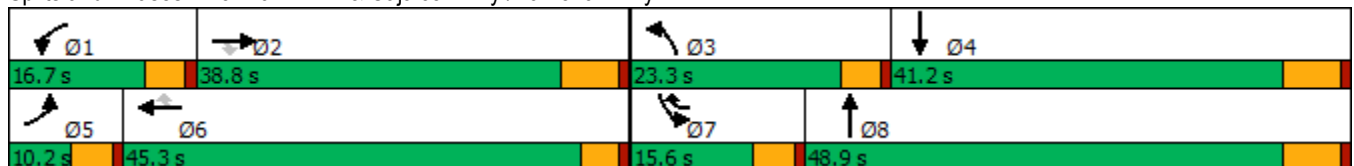



HCM 6th Signalized Intersection Summary  
 3: Harvill Av. & Cajalco Exwy./Ramona Exwy.

MFBC Building 17 (JN 13697)

09/23/2022



Movement	EBL	EBT	EBR	WBL	WBT	WBR	NBL	NBT	NBR	SBL	SBT	SBR
Lane Configurations	↘	↑↑	↗	↘↗	↑↑	↗	↘↗	↑↑		↘↗	↑↑	
Traffic Volume (veh/h)	47	680	50	167	677	102	297	337	75	189	116	27
Future Volume (veh/h)	47	680	50	167	677	102	297	337	75	189	116	27
Initial Q (Qb), veh	0	0	0	0	0	0	0	0	0	0	0	0
Ped-Bike Adj(A_pbT)	1.00		1.00	1.00		1.00	1.00		0.99	1.00		1.00
Parking Bus, Adj	1.00	1.00	1.00	1.00	1.00	1.00	1.00	1.00	1.00	1.00	1.00	1.00
Work Zone On Approach		No			No			No			No	
Adj Sat Flow, veh/h/ln	1900	1900	1900	1900	1900	1900	1900	1900	1900	1900	1900	1900
Adj Flow Rate, veh/h	51	731	3	180	728	42	319	362	27	203	125	27
Peak Hour Factor	0.93	0.93	0.93	0.93	0.93	0.93	0.93	0.93	0.93	0.93	0.93	0.93
Percent Heavy Veh, %	0	0	0	0	0	0	0	0	0	0	0	0
Cap, veh/h	67	874	390	246	993	566	390	1382	103	268	1102	232
Arrive On Green	0.04	0.24	0.24	0.07	0.28	0.28	0.11	0.41	0.41	0.08	0.37	0.37
Sat Flow, veh/h	1810	3610	1610	3510	3610	1610	3510	3403	253	3510	2968	625
Grp Volume(v), veh/h	51	731	3	180	728	42	319	191	198	203	75	77
Grp Sat Flow(s),veh/h/ln	1810	1805	1610	1755	1805	1610	1755	1805	1851	1755	1805	1788
Q Serve(g_s), s	2.9	20.2	0.1	5.3	19.3	1.8	9.3	7.4	7.5	6.0	2.9	3.0
Cycle Q Clear(g_c), s	2.9	20.2	0.1	5.3	19.3	1.8	9.3	7.4	7.5	6.0	2.9	3.0
Prop In Lane	1.00		1.00	1.00		1.00	1.00		0.14	1.00		0.35
Lane Grp Cap(c), veh/h	67	874	390	246	993	566	390	733	752	268	670	664
V/C Ratio(X)	0.77	0.84	0.01	0.73	0.73	0.07	0.82	0.26	0.26	0.76	0.11	0.12
Avail Cap(c_a), veh/h	96	1119	499	404	1401	748	624	733	752	367	670	664
HCM Platoon Ratio	1.00	1.00	1.00	1.00	1.00	1.00	1.00	1.00	1.00	1.00	1.00	1.00
Upstream Filter(I)	1.00	1.00	1.00	1.00	1.00	1.00	1.00	1.00	1.00	1.00	1.00	1.00
Uniform Delay (d), s/veh	50.2	37.9	30.3	47.9	34.6	22.7	45.7	20.7	20.8	47.6	21.7	21.7
Incr Delay (d2), s/veh	10.7	4.5	0.0	1.6	1.2	0.1	2.0	0.9	0.9	3.6	0.3	0.4
Initial Q Delay(d3),s/veh	0.0	0.0	0.0	0.0	0.0	0.0	0.0	0.0	0.0	0.0	0.0	0.0
%ile BackOfQ(50%),veh/ln	1.5	9.0	0.1	2.3	8.1	0.7	4.0	3.1	3.2	2.6	1.2	1.2
Unsig. Movement Delay, s/veh												
LnGrp Delay(d),s/veh	60.9	42.4	30.3	49.5	35.8	22.7	47.7	21.6	21.6	51.2	22.0	22.1
LnGrp LOS	E	D	C	D	D	C	D	C	C	D	C	C
Approach Vol, veh/h		785			950			708			355	
Approach Delay, s/veh		43.6			37.8			33.4			38.7	
Approach LOS		D			D			C			D	
Timer - Assigned Phs	1	2	3	4	5	6	7	8				
Phs Duration (G+Y+Rc), s	12.0	31.6	16.3	45.2	8.5	35.1	12.6	48.9				
Change Period (Y+Rc), s	4.6	6.2	4.6	6.2	4.6	* 6.2	4.6	6.2				
Max Green Setting (Gmax), s	12.1	32.6	18.7	35.0	5.6	* 41	11.0	42.7				
Max Q Clear Time (g_c+I1), s	7.3	22.2	11.3	5.0	4.9	21.3	8.0	9.5				
Green Ext Time (p_c), s	0.1	3.2	0.4	0.7	0.0	4.4	0.1	2.0				

Intersection Summary

HCM 6th Ctrl Delay	38.4
HCM 6th LOS	D

Notes

\* HCM 6th computational engine requires equal clearance times for the phases crossing the barrier.

Timings  
4: I-215 SB Ramps & Ramona Exwy.

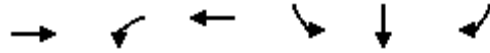

Lane Group	EBT	WBL	WBT	SBL	SBT	SBR
Lane Configurations	↑↑	↖	↑↑	↖	↖	↖
Traffic Volume (vph)	759	328	1121	817	2	210
Future Volume (vph)	759	328	1121	817	2	210
Turn Type	NA	Prot	NA	Split	NA	Perm
Protected Phases	2	1	6	4	4	
Permitted Phases						4
Detector Phase	2	1	6	4	4	4
Switch Phase						
Minimum Initial (s)	5.0	5.0	5.0	5.0	5.0	5.0
Minimum Split (s)	11.0	9.5	31.0	10.5	10.5	10.5
Total Split (s)	44.0	27.0	71.0	39.0	39.0	39.0
Total Split (%)	40.0%	24.5%	64.5%	35.5%	35.5%	35.5%
Yellow Time (s)	5.0	3.5	5.0	4.5	4.5	4.5
All-Red Time (s)	1.0	1.0	1.0	1.0	1.0	1.0
Lost Time Adjust (s)	0.0	0.0	0.0	0.0	0.0	0.0
Total Lost Time (s)	6.0	4.5	6.0	5.5	5.5	5.5
Lead/Lag	Lag	Lead				
Lead-Lag Optimize?	Yes	Yes				
Recall Mode	C-Max	None	C-Max	Max	Max	Max
Act Effct Green (s)	38.5	22.0	65.0	33.5	33.5	33.5
Actuated g/C Ratio	0.35	0.20	0.59	0.30	0.30	0.30
v/c Ratio	0.92	0.93	0.54	0.80	0.80	0.39
Control Delay	44.6	48.7	4.4	48.2	48.3	20.4
Queue Delay	0.6	0.0	0.7	61.7	61.7	0.0
Total Delay	45.2	48.7	5.1	109.9	110.0	20.4
LOS	D	D	A	F	F	C
Approach Delay	45.2		15.0		91.7	
Approach LOS	D		B		F	

Intersection Summary

Cycle Length: 110  
 Actuated Cycle Length: 110  
 Offset: 34 (31%), Referenced to phase 2:EBT and 6:WBT, Start of Yellow  
 Natural Cycle: 90  
 Control Type: Actuated-Coordinated  
 Maximum v/c Ratio: 0.93  
 Intersection Signal Delay: 46.3  
 Intersection LOS: D  
 Intersection Capacity Utilization 148.5%  
 ICU Level of Service H  
 Analysis Period (min) 15

Splits and Phases: 4: I-215 SB Ramps & Ramona Exwy.

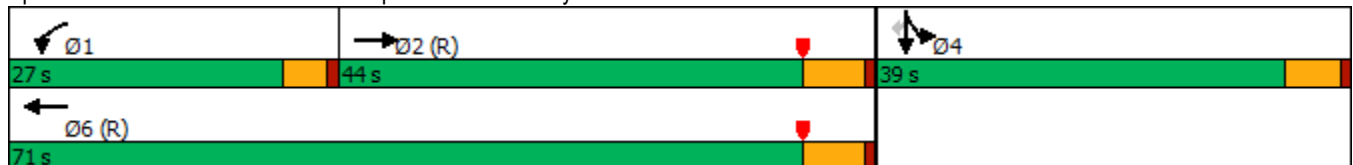

HCM 6th Signalized Intersection Summary  
 4: I-215 SB Ramps & Ramona Exwy.

MFBC Building 17 (JN 13697)  
 09/23/2022



Movement	EBL	EBT	EBR	WBL	WBT	WBR	NBL	NBT	NBR	SBL	SBT	SBR
Lane Configurations		↑↑		↖	↑↑					↖	↑	↗
Traffic Volume (veh/h)	0	759	364	328	1121	0	0	0	0	817	2	210
Future Volume (veh/h)	0	759	364	328	1121	0	0	0	0	817	2	210
Initial Q (Qb), veh	0	0	0	0	0	0				0	0	0
Ped-Bike Adj(A_pbT)	1.00		0.99	1.00		1.00				1.00		1.00
Parking Bus, Adj	1.00	1.00	1.00	1.00	1.00	1.00				1.00	1.00	1.00
Work Zone On Approach		No			No						No	
Adj Sat Flow, veh/h/ln	0	1900	1900	1900	1900	0				1900	1900	1900
Adj Flow Rate, veh/h	0	774	242	335	1144	0				835	0	151
Peak Hour Factor	0.98	0.98	0.98	0.98	0.98	0.98				0.98	0.98	0.98
Percent Heavy Veh, %	0	0	0	0	0	0				0	0	0
Cap, veh/h	0	940	294	365	2133	0				1102	0	490
Arrive On Green	0.00	0.35	0.35	0.12	0.35	0.00				0.30	0.00	0.30
Sat Flow, veh/h	0	2792	843	1810	3705	0				3619	0	1610
Grp Volume(v), veh/h	0	518	498	335	1144	0				835	0	151
Grp Sat Flow(s),veh/h/ln	0	1805	1735	1810	1805	0				1810	0	1610
Q Serve(g_s), s	0.0	28.8	28.9	20.1	27.8	0.0				22.9	0.0	7.9
Cycle Q Clear(g_c), s	0.0	28.8	28.9	20.1	27.8	0.0				22.9	0.0	7.9
Prop In Lane	0.00		0.49	1.00		0.00				1.00		1.00
Lane Grp Cap(c), veh/h	0	629	605	365	2133	0				1102	0	490
V/C Ratio(X)	0.00	0.82	0.82	0.92	0.54	0.00				0.76	0.00	0.31
Avail Cap(c_a), veh/h	0	629	605	370	2133	0				1102	0	490
HCM Platoon Ratio	1.00	1.00	1.00	0.60	0.60	1.00				1.00	1.00	1.00
Upstream Filter(I)	0.00	0.53	0.53	0.64	0.64	0.00				1.00	0.00	1.00
Uniform Delay (d), s/veh	0.0	32.8	32.8	47.4	23.5	0.0				34.6	0.0	29.4
Incr Delay (d2), s/veh	0.0	6.5	6.8	19.7	0.6	0.0				4.9	0.0	1.6
Initial Q Delay(d3),s/veh	0.0	0.0	0.0	0.0	0.0	0.0				0.0	0.0	0.0
%ile BackOfQ(50%),veh/ln	0.0	12.9	12.4	11.3	12.5	0.0				10.4	0.0	3.2
Unsig. Movement Delay, s/veh												
LnGrp Delay(d),s/veh	0.0	39.3	39.6	67.1	24.1	0.0				39.5	0.0	31.0
LnGrp LOS	A	D	D	E	C	A				D	A	C
Approach Vol, veh/h		1016			1479						986	
Approach Delay, s/veh		39.4			33.8						38.2	
Approach LOS		D			C						D	
Timer - Assigned Phs	1	2		4		6						
Phs Duration (G+Y+Rc), s	26.7	44.3		39.0		71.0						
Change Period (Y+Rc), s	4.5	6.0		5.5		6.0						
Max Green Setting (Gmax), s	22.5	38.0		33.5		65.0						
Max Q Clear Time (g_c+I1), s	22.1	30.9		24.9		29.8						
Green Ext Time (p_c), s	0.0	2.4		2.6		5.3						

Intersection Summary

HCM 6th Ctrl Delay	36.7
HCM 6th LOS	D

Notes

User approved volume balancing among the lanes for turning movement.

Timings  
5: I-215 NB Ramps & Ramona Exwy.



Lane Group	EBL	EBT	WBT	WBR	NBL	NBT	NBR
Lane Configurations	↶	↷↷	↷↷	↷	↶	↷	↷
Traffic Volume (vph)	159	1417	1051	740	398	4	612
Future Volume (vph)	159	1417	1051	740	398	4	612
Turn Type	Prot	NA	NA	Perm	Split	NA	Perm
Protected Phases	5	2	6		8	8	
Permitted Phases				6			8
Detector Phase	5	2	6	6	8	8	8
Switch Phase							
Minimum Initial (s)	5.0	5.0	5.0	5.0	5.0	5.0	5.0
Minimum Split (s)	9.5	11.0	26.0	26.0	10.5	10.5	10.5
Total Split (s)	23.0	68.0	45.0	45.0	42.0	42.0	42.0
Total Split (%)	20.9%	61.8%	40.9%	40.9%	38.2%	38.2%	38.2%
Yellow Time (s)	3.5	5.0	5.0	5.0	4.5	4.5	4.5
All-Red Time (s)	1.0	1.0	1.0	1.0	1.0	1.0	1.0
Lost Time Adjust (s)	0.0	0.0	0.0	0.0	0.0	0.0	0.0
Total Lost Time (s)	4.5	6.0	6.0	6.0	5.5	5.5	5.5
Lead/Lag	Lead		Lag	Lag			
Lead-Lag Optimize?	Yes		Yes	Yes			
Recall Mode	None	C-Max	C-Max	C-Max	None	None	None
Act Effct Green (s)	14.7	62.0	42.8	42.8	36.5	36.5	36.5
Actuated g/C Ratio	0.13	0.56	0.39	0.39	0.33	0.33	0.33
v/c Ratio	0.68	0.72	0.77	0.76	0.36	0.37	1.08
Control Delay	42.4	28.0	34.7	12.0	30.2	30.3	92.3
Queue Delay	0.0	49.5	0.0	0.0	0.0	0.0	0.0
Total Delay	42.4	77.5	34.7	12.0	30.2	30.3	92.3
LOS	D	E	C	B	C	C	F
Approach Delay		73.9	25.3			67.7	
Approach LOS		E	C			E	

Intersection Summary

Cycle Length: 110  
 Actuated Cycle Length: 110  
 Offset: 0 (0%), Referenced to phase 2:EBT and 6:WBT, Start of Yellow, Master Intersection  
 Natural Cycle: 75  
 Control Type: Actuated-Coordinated  
 Maximum v/c Ratio: 1.08  
 Intersection Signal Delay: 52.6  
 Intersection LOS: D  
 Intersection Capacity Utilization 148.5%  
 ICU Level of Service H  
 Analysis Period (min) 15

Splits and Phases: 5: I-215 NB Ramps & Ramona Exwy.

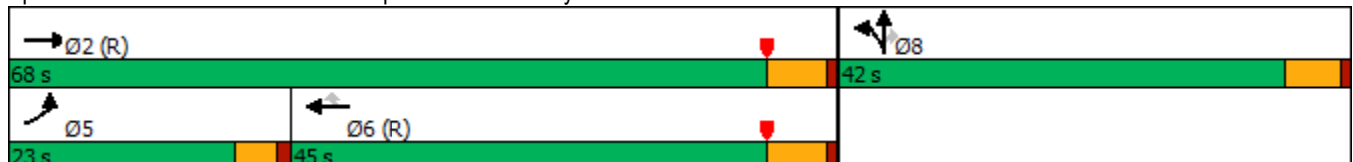

HCM 6th Signalized Intersection Summary  
5: I-215 NB Ramps & Ramona Exwy.

MFBC Building 17 (JN 13697)  
09/23/2022



Movement	EBL	EBT	EBR	WBL	WBT	WBR	NBL	NBT	NBR	SBL	SBT	SBR
Lane Configurations	↗	↗↗			↗↗	↗	↗	↗	↗			
Traffic Volume (veh/h)	159	1417	0	0	1051	740	398	4	612	0	0	0
Future Volume (veh/h)	159	1417	0	0	1051	740	398	4	612	0	0	0
Initial Q (Qb), veh	0	0	0	0	0	0	0	0	0			
Ped-Bike Adj(A_pbT)	1.00		1.00	1.00		1.00	1.00		1.00			
Parking Bus, Adj	1.00	1.00	1.00	1.00	1.00	1.00	1.00	1.00	1.00			
Work Zone On Approach		No			No			No				
Adj Sat Flow, veh/h/ln	1900	1900	0	0	1900	1900	1900	1900	1900			
Adj Flow Rate, veh/h	164	1461	0	0	1084	615	413	0	479			
Peak Hour Factor	0.97	0.97	0.97	0.97	0.97	0.97	0.97	0.97	0.97			
Percent Heavy Veh, %	0	0	0	0	0	0	0	0	0			
Cap, veh/h	193	2089	0	0	1557	695	1146	0	510			
Arrive On Green	0.21	1.00	0.00	0.00	0.43	0.43	0.32	0.00	0.32			
Sat Flow, veh/h	1810	3705	0	0	3705	1610	3619	0	1610			
Grp Volume(v), veh/h	164	1461	0	0	1084	615	413	0	479			
Grp Sat Flow(s),veh/h/ln	1810	1805	0	0	1805	1610	1810	0	1610			
Q Serve(g_s), s	9.6	0.0	0.0	0.0	26.8	38.7	9.7	0.0	31.8			
Cycle Q Clear(g_c), s	9.6	0.0	0.0	0.0	26.8	38.7	9.7	0.0	31.8			
Prop In Lane	1.00		0.00	0.00		1.00	1.00		1.00			
Lane Grp Cap(c), veh/h	193	2089	0	0	1557	695	1146	0	510			
V/C Ratio(X)	0.85	0.70	0.00	0.00	0.70	0.89	0.36	0.00	0.94			
Avail Cap(c_a), veh/h	304	2089	0	0	1557	695	1201	0	534			
HCM Platoon Ratio	2.00	2.00	1.00	1.00	1.00	1.00	1.00	1.00	1.00			
Upstream Filter(I)	0.34	0.34	0.00	0.00	1.00	1.00	1.00	0.00	1.00			
Uniform Delay (d), s/veh	42.4	0.0	0.0	0.0	25.4	28.8	29.0	0.0	36.6			
Incr Delay (d2), s/veh	4.7	0.7	0.0	0.0	2.6	15.4	0.2	0.0	24.3			
Initial Q Delay(d3),s/veh	0.0	0.0	0.0	0.0	0.0	0.0	0.0	0.0	0.0			
%ile BackOfQ(50%),veh/ln	3.9	0.2	0.0	0.0	11.1	16.5	4.1	0.0	15.3			
Unsig. Movement Delay, s/veh												
LnGrp Delay(d),s/veh	47.1	0.7	0.0	0.0	28.0	44.2	29.2	0.0	60.8			
LnGrp LOS	D	A	A	A	C	D	C	A	E			
Approach Vol, veh/h		1625			1699			892				
Approach Delay, s/veh		5.4			33.9			46.2				
Approach LOS		A			C			D				
Timer - Assigned Phs		2			5	6		8				
Phs Duration (G+Y+Rc), s		69.7			16.2	53.5		40.3				
Change Period (Y+Rc), s		6.0			4.5	6.0		5.5				
Max Green Setting (Gmax), s		62.0			18.5	39.0		36.5				
Max Q Clear Time (g_c+I1), s		2.0			11.6	40.7		33.8				
Green Ext Time (p_c), s		8.0			0.2	0.0		1.0				

Intersection Summary

HCM 6th Ctrl Delay	25.5
HCM 6th LOS	C

Notes

User approved volume balancing among the lanes for turning movement.

Intersection						
Int Delay, s/veh	0.1					
Movement	WBL	WBR	NBT	NBR	SBL	SBT
Lane Configurations	↙	↗	↕		↙	↕
Traffic Vol, veh/h	0	6	355	1	0	366
Future Vol, veh/h	0	6	355	1	0	366
Conflicting Peds, #/hr	0	0	0	0	0	0
Sign Control	Stop	Stop	Free	Free	Free	Free
RT Channelized	-	None	-	None	-	None
Storage Length	0	0	-	-	130	-
Veh in Median Storage, #	1	-	0	-	-	0
Grade, %	0	-	0	-	-	0
Peak Hour Factor	90	90	90	90	90	90
Heavy Vehicles, %	0	0	0	0	0	0
Mvmt Flow	0	7	394	1	0	407

Major/Minor	Minor1	Major1	Major2		
Conflicting Flow All	599	198	0	0	395
Stage 1	395	-	-	-	-
Stage 2	204	-	-	-	-
Critical Hdwy	6.8	6.9	-	-	4.1
Critical Hdwy Stg 1	5.8	-	-	-	-
Critical Hdwy Stg 2	5.8	-	-	-	-
Follow-up Hdwy	3.5	3.3	-	-	2.2
Pot Cap-1 Maneuver	438	816	-	-	1175
Stage 1	656	-	-	-	-
Stage 2	816	-	-	-	-
Platoon blocked, %			-	-	-
Mov Cap-1 Maneuver	438	816	-	-	1175
Mov Cap-2 Maneuver	526	-	-	-	-
Stage 1	656	-	-	-	-
Stage 2	816	-	-	-	-

Approach	WB	NB	SB
HCM Control Delay, s	9.4	0	0
HCM LOS	A		

Minor Lane/Major Mvmt	NBT	NBRWBLn1	WBLn2	SBL	SBT
Capacity (veh/h)	-	-	-	816	1175
HCM Lane V/C Ratio	-	-	-	0.008	-
HCM Control Delay (s)	-	-	0	9.4	0
HCM Lane LOS	-	-	A	A	A
HCM 95th %tile Q(veh)	-	-	-	0	0

Timings  
3: Harvill Av. & Cajalco Exwy./Ramona Exwy.

MFBC Building 17 (JN 13697)

09/23/2022

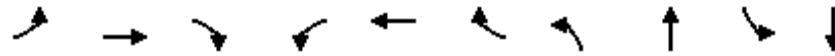

Lane Group	EBL	EBT	EBR	WBL	WBT	WBR	NBL	NBT	SBL	SBT
Lane Configurations	↙	↑↑	↗	↙↗	↑↑	↗	↙↗	↑↘	↙↗	↑↘
Traffic Volume (vph)	24	723	207	132	637	187	165	144	222	211
Future Volume (vph)	24	723	207	132	637	187	165	144	222	211
Turn Type	Prot	NA	Perm	Prot	NA	pm+ov	Prot	NA	Prot	NA
Protected Phases	5	2		1	6	7	3	8	7	4
Permitted Phases			2			6				
Detector Phase	5	2	2	1	6	7	3	8	7	4
Switch Phase										
Minimum Initial (s)	5.0	10.0	10.0	5.0	10.0	5.0	5.0	10.0	5.0	10.0
Minimum Split (s)	9.6	36.2	36.2	9.6	32.5	9.6	9.6	16.2	9.6	41.2
Total Split (s)	10.2	38.8	38.8	16.7	45.3	15.6	23.3	48.9	15.6	41.2
Total Split (%)	8.5%	32.3%	32.3%	13.9%	37.8%	13.0%	19.4%	40.8%	13.0%	34.3%
Yellow Time (s)	3.6	5.2	5.2	3.6	3.5	3.6	3.6	5.2	3.6	5.2
All-Red Time (s)	1.0	1.0	1.0	1.0	1.0	1.0	1.0	1.0	1.0	1.0
Lost Time Adjust (s)	0.0	0.0	0.0	0.0	0.0	0.0	0.0	0.0	0.0	0.0
Total Lost Time (s)	4.6	6.2	6.2	4.6	4.5	4.6	4.6	6.2	4.6	6.2
Lead/Lag	Lead	Lag	Lag	Lead	Lag	Lead	Lead	Lag	Lead	Lag
Lead-Lag Optimize?	Yes	Yes	Yes	Yes	Yes	Yes	Yes	Yes	Yes	Yes
Recall Mode	None	None	None	None	None	None	None	Max	None	Max
Act Effct Green (s)	5.4	29.4	29.4	9.0	38.9	53.8	10.1	42.9	10.4	43.2
Actuated g/C Ratio	0.05	0.26	0.26	0.08	0.34	0.47	0.09	0.38	0.09	0.38
v/c Ratio	0.31	0.83	0.38	0.51	0.55	0.23	0.57	0.21	0.74	0.20
Control Delay	64.0	48.5	6.4	57.6	32.9	3.2	57.5	13.8	65.8	24.0
Queue Delay	0.0	0.0	0.0	0.0	0.0	0.0	0.0	0.0	0.0	0.0
Total Delay	64.0	48.5	6.4	57.6	32.9	3.2	57.5	13.8	65.8	24.0
LOS	E	D	A	E	C	A	E	B	E	C
Approach Delay		39.7			30.5			30.4		43.8
Approach LOS		D			C			C		D

Intersection Summary

Cycle Length: 120  
 Actuated Cycle Length: 113.4  
 Natural Cycle: 100  
 Control Type: Actuated-Uncoordinated  
 Maximum v/c Ratio: 0.83  
 Intersection Signal Delay: 35.8  
 Intersection LOS: D  
 Intersection Capacity Utilization 56.8%  
 ICU Level of Service B  
 Analysis Period (min) 15

Splits and Phases: 3: Harvill Av. & Cajalco Exwy./Ramona Exwy.

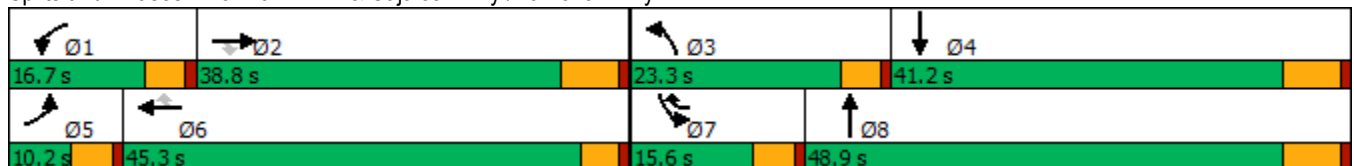

HCM 6th Signalized Intersection Summary  
 3: Harvill Av. & Cajalco Exwy./Ramona Exwy.

MFBC Building 17 (JN 13697)

09/23/2022



Movement	EBL	EBT	EBR	WBL	WBT	WBR	NBL	NBT	NBR	SBL	SBT	SBR
Lane Configurations												
Traffic Volume (veh/h)	24	723	207	132	637	187	165	144	125	222	211	35
Future Volume (veh/h)	24	723	207	132	637	187	165	144	125	222	211	35
Initial Q (Qb), veh	0	0	0	0	0	0	0	0	0	0	0	0
Ped-Bike Adj(A_pbT)	1.00		1.00	1.00		1.00	1.00		1.00	1.00		1.00
Parking Bus, Adj	1.00	1.00	1.00	1.00	1.00	1.00	1.00	1.00	1.00	1.00	1.00	1.00
Work Zone On Approach		No			No			No			No	
Adj Sat Flow, veh/h/ln	1900	1900	1900	1900	1900	1900	1900	1900	1900	1900	1900	1900
Adj Flow Rate, veh/h	26	777	110	142	685	121	177	155	66	239	227	27
Peak Hour Factor	0.93	0.93	0.93	0.93	0.93	0.93	0.93	0.93	0.93	0.93	0.93	0.93
Percent Heavy Veh, %	0	0	0	0	0	0	0	0	0	0	0	0
Cap, veh/h	46	918	409	205	1038	602	245	998	407	302	1352	159
Arrive On Green	0.03	0.25	0.25	0.06	0.29	0.29	0.07	0.40	0.40	0.09	0.42	0.42
Sat Flow, veh/h	1810	3610	1610	3510	3610	1610	3510	2501	1020	3510	3253	383
Grp Volume(v), veh/h	26	777	110	142	685	121	177	110	111	239	125	129
Grp Sat Flow(s),veh/h/ln	1810	1805	1610	1755	1805	1610	1755	1805	1716	1755	1805	1831
Q Serve(g_s), s	1.5	21.9	5.8	4.2	17.8	5.4	5.3	4.2	4.4	7.1	4.6	4.7
Cycle Q Clear(g_c), s	1.5	21.9	5.8	4.2	17.8	5.4	5.3	4.2	4.4	7.1	4.6	4.7
Prop In Lane	1.00		1.00	1.00		1.00	1.00		0.59	1.00		0.21
Lane Grp Cap(c), veh/h	46	918	409	205	1038	602	245	721	685	302	750	761
V/C Ratio(X)	0.57	0.85	0.27	0.69	0.66	0.20	0.72	0.15	0.16	0.79	0.17	0.17
Avail Cap(c_a), veh/h	95	1100	491	397	1377	753	614	721	685	361	750	761
HCM Platoon Ratio	1.00	1.00	1.00	1.00	1.00	1.00	1.00	1.00	1.00	1.00	1.00	1.00
Upstream Filter(I)	1.00	1.00	1.00	1.00	1.00	1.00	1.00	1.00	1.00	1.00	1.00	1.00
Uniform Delay (d), s/veh	51.6	37.9	31.9	49.4	33.5	22.7	48.7	20.6	20.6	47.9	19.6	19.6
Incr Delay (d2), s/veh	4.1	5.4	0.3	1.6	0.7	0.2	1.5	0.4	0.5	7.8	0.5	0.5
Initial Q Delay(d3),s/veh	0.0	0.0	0.0	0.0	0.0	0.0	0.0	0.0	0.0	0.0	0.0	0.0
%ile BackOfQ(50%),veh/ln	0.7	9.8	2.2	1.8	7.4	2.0	2.3	1.7	1.8	3.3	1.9	2.0
Unsig. Movement Delay, s/veh												
LnGrp Delay(d),s/veh	55.7	43.3	32.3	51.0	34.2	22.8	50.3	21.0	21.1	55.8	20.1	20.1
LnGrp LOS	E	D	C	D	C	C	D	C	C	E	C	C
Approach Vol, veh/h		913			948			398			493	
Approach Delay, s/veh		42.3			35.3			34.1			37.4	
Approach LOS		D			D			C			D	
Timer - Assigned Phs	1	2	3	4	5	6	7	8				
Phs Duration (G+Y+Rc), s	10.9	33.4	12.1	50.7	7.3	37.0	13.8	48.9				
Change Period (Y+Rc), s	4.6	6.2	4.6	6.2	4.6	* 6.2	4.6	6.2				
Max Green Setting (Gmax), s	12.1	32.6	18.7	35.0	5.6	* 41	11.0	42.7				
Max Q Clear Time (g_c+I1), s	6.2	23.9	7.3	6.7	3.5	19.8	9.1	6.4				
Green Ext Time (p_c), s	0.1	3.3	0.2	1.2	0.0	4.5	0.1	1.1				

Intersection Summary

HCM 6th Ctrl Delay	37.8
HCM 6th LOS	D

Notes

\* HCM 6th computational engine requires equal clearance times for the phases crossing the barrier.



Timings  
4: I-215 SB Ramps & Ramona Exwy.

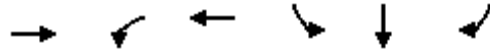

Lane Group	EBT	WBL	WBT	SBL	SBT	SBR
Lane Configurations	↑↑	↖	↑↑	↖	↖	↖
Traffic Volume (vph)	911	369	915	853	8	184
Future Volume (vph)	911	369	915	853	8	184
Turn Type	NA	Prot	NA	Split	NA	Perm
Protected Phases	2	1	6	4	4	
Permitted Phases						4
Detector Phase	2	1	6	4	4	4
Switch Phase						
Minimum Initial (s)	5.0	5.0	5.0	5.0	5.0	5.0
Minimum Split (s)	11.0	9.5	31.0	10.5	10.5	10.5
Total Split (s)	44.0	27.0	71.0	39.0	39.0	39.0
Total Split (%)	40.0%	24.5%	64.5%	35.5%	35.5%	35.5%
Yellow Time (s)	5.0	3.5	5.0	4.5	4.5	4.5
All-Red Time (s)	1.0	1.0	1.0	1.0	1.0	1.0
Lost Time Adjust (s)	0.0	0.0	0.0	0.0	0.0	0.0
Total Lost Time (s)	6.0	4.5	6.0	5.5	5.5	5.5
Lead/Lag	Lag	Lead				
Lead-Lag Optimize?	Yes	Yes				
Recall Mode	C-Max	None	C-Max	Max	Max	Max
Act Effct Green (s)	38.0	22.5	65.0	33.5	33.5	33.5
Actuated g/C Ratio	0.35	0.20	0.59	0.30	0.30	0.30
v/c Ratio	1.03	1.01	0.43	0.83	0.84	0.32
Control Delay	69.1	69.7	5.2	50.4	51.6	10.3
Queue Delay	12.9	0.0	0.4	72.5	72.1	0.0
Total Delay	82.0	69.7	5.6	122.9	123.7	10.3
LOS	F	E	A	F	F	B
Approach Delay	82.0		24.0		103.4	
Approach LOS	F		C		F	

Intersection Summary

Cycle Length: 110  
 Actuated Cycle Length: 110  
 Offset: 34 (31%), Referenced to phase 2:EBT and 6:WBT, Start of Yellow  
 Natural Cycle: 90  
 Control Type: Actuated-Coordinated  
 Maximum v/c Ratio: 1.03  
 Intersection Signal Delay: 67.5  
 Intersection LOS: E  
 Intersection Capacity Utilization 138.9%  
 ICU Level of Service H  
 Analysis Period (min) 15

Splits and Phases: 4: I-215 SB Ramps & Ramona Exwy.



HCM 6th Signalized Intersection Summary  
 4: I-215 SB Ramps & Ramona Exwy.

MFBC Building 17 (JN 13697)

09/23/2022



Movement	EBL	EBT	EBR	WBL	WBT	WBR	NBL	NBT	NBR	SBL	SBT	SBR
Lane Configurations		↑↑		↖	↑↑					↖	↑	↖
Traffic Volume (veh/h)	0	911	348	369	915	0	0	0	0	853	8	184
Future Volume (veh/h)	0	911	348	369	915	0	0	0	0	853	8	184
Initial Q (Qb), veh	0	0	0	0	0	0				0	0	0
Ped-Bike Adj(A_pbT)	1.00		1.00	1.00		1.00				1.00		1.00
Parking Bus, Adj	1.00	1.00	1.00	1.00	1.00	1.00				1.00	1.00	1.00
Work Zone On Approach		No			No						No	
Adj Sat Flow, veh/h/ln	0	1900	1900	1900	1900	0				1900	1900	1900
Adj Flow Rate, veh/h	0	920	244	373	924	0				868	0	127
Peak Hour Factor	0.99	0.99	0.99	0.99	0.99	0.99				0.99	0.99	0.99
Percent Heavy Veh, %	0	0	0	0	0	0				0	0	0
Cap, veh/h	0	975	258	370	2133	0				1102	0	490
Arrive On Green	0.00	0.35	0.35	0.12	0.35	0.00				0.30	0.00	0.30
Sat Flow, veh/h	0	2918	747	1810	3705	0				3619	0	1610
Grp Volume(v), veh/h	0	588	576	373	924	0				868	0	127
Grp Sat Flow(s),veh/h/ln	0	1805	1765	1810	1805	0				1810	0	1610
Q Serve(g_s), s	0.0	34.8	34.9	22.5	21.5	0.0				24.1	0.0	6.6
Cycle Q Clear(g_c), s	0.0	34.8	34.9	22.5	21.5	0.0				24.1	0.0	6.6
Prop In Lane	0.00		0.42	1.00		0.00				1.00		1.00
Lane Grp Cap(c), veh/h	0	624	610	370	2133	0				1102	0	490
V/C Ratio(X)	0.00	0.94	0.95	1.01	0.43	0.00				0.79	0.00	0.26
Avail Cap(c_a), veh/h	0	624	610	370	2133	0				1102	0	490
HCM Platoon Ratio	1.00	1.00	1.00	0.60	0.60	1.00				1.00	1.00	1.00
Upstream Filter(I)	0.00	0.48	0.48	0.79	0.79	0.00				1.00	0.00	1.00
Uniform Delay (d), s/veh	0.0	34.9	35.0	48.2	21.5	0.0				35.0	0.0	28.9
Incr Delay (d2), s/veh	0.0	14.5	15.1	43.5	0.5	0.0				5.7	0.0	1.3
Initial Q Delay(d3),s/veh	0.0	0.0	0.0	0.0	0.0	0.0				0.0	0.0	0.0
%ile BackOfQ(50%),veh/ln	0.0	16.6	16.4	14.8	9.7	0.0				11.0	0.0	2.6
Unsig. Movement Delay, s/veh												
LnGrp Delay(d),s/veh	0.0	49.5	50.1	91.8	22.0	0.0				40.7	0.0	30.2
LnGrp LOS	A	D	D	F	C	A				D	A	C
Approach Vol, veh/h		1164			1297						995	
Approach Delay, s/veh		49.8			42.0						39.4	
Approach LOS		D			D						D	
Timer - Assigned Phs	1	2		4		6						
Phs Duration (G+Y+Rc), s	27.0	44.0		39.0		71.0						
Change Period (Y+Rc), s	4.5	6.0		5.5		6.0						
Max Green Setting (Gmax), s	22.5	38.0		33.5		65.0						
Max Q Clear Time (g_c+I1), s	24.5	36.9		26.1		23.5						
Green Ext Time (p_c), s	0.0	0.6		2.4		4.0						

Intersection Summary

HCM 6th Ctrl Delay	43.9
HCM 6th LOS	D

Notes

User approved volume balancing among the lanes for turning movement.

Timings  
5: I-215 NB Ramps & Ramona Exwy.



Lane Group	EBL	EBT	WBT	WBR	NBL	NBT	NBR
Lane Configurations	↶	↷	↶	↷	↶	↷	↷
Traffic Volume (vph)	121	1643	913	652	371	4	461
Future Volume (vph)	121	1643	913	652	371	4	461
Turn Type	Prot	NA	NA	Perm	Split	NA	Perm
Protected Phases	5	2	6		8	8	
Permitted Phases				6			8
Detector Phase	5	2	6	6	8	8	8
Switch Phase							
Minimum Initial (s)	5.0	5.0	5.0	5.0	5.0	5.0	5.0
Minimum Split (s)	9.5	11.0	26.0	26.0	10.5	10.5	10.5
Total Split (s)	23.0	68.0	45.0	45.0	42.0	42.0	42.0
Total Split (%)	20.9%	61.8%	40.9%	40.9%	38.2%	38.2%	38.2%
Yellow Time (s)	3.5	5.0	5.0	5.0	4.5	4.5	4.5
All-Red Time (s)	1.0	1.0	1.0	1.0	1.0	1.0	1.0
Lost Time Adjust (s)	0.0	0.0	0.0	0.0	0.0	0.0	0.0
Total Lost Time (s)	4.5	6.0	6.0	6.0	5.5	5.5	5.5
Lead/Lag	Lead		Lag	Lag			
Lead-Lag Optimize?	Yes		Yes	Yes			
Recall Mode	None	C-Max	C-Max	C-Max	None	None	None
Act Effct Green (s)	13.1	65.2	47.6	47.6	33.3	33.3	33.3
Actuated g/C Ratio	0.12	0.59	0.43	0.43	0.30	0.30	0.30
v/c Ratio	0.60	0.82	0.62	0.67	0.38	0.39	0.91
Control Delay	39.1	30.9	28.0	7.4	31.7	31.9	52.7
Queue Delay	0.0	48.6	0.0	0.0	0.0	0.0	0.0
Total Delay	39.1	79.4	28.0	7.4	31.7	31.9	52.7
LOS	D	E	C	A	C	C	D
Approach Delay		76.7	19.4			43.3	
Approach LOS		E	B			D	

Intersection Summary

Cycle Length: 110  
 Actuated Cycle Length: 110  
 Offset: 0 (0%), Referenced to phase 2:EBT and 6:WBT, Start of Yellow, Master Intersection  
 Natural Cycle: 60  
 Control Type: Actuated-Coordinated  
 Maximum v/c Ratio: 0.91  
 Intersection Signal Delay: 48.4  
 Intersection LOS: D  
 Intersection Capacity Utilization 138.9%  
 ICU Level of Service H  
 Analysis Period (min) 15

Splits and Phases: 5: I-215 NB Ramps & Ramona Exwy.



HCM 6th Signalized Intersection Summary  
5: I-215 NB Ramps & Ramona Exwy.

MFBC Building 17 (JN 13697)  
09/23/2022



Movement	EBL	EBT	EBR	WBL	WBT	WBR	NBL	NBT	NBR	SBL	SBT	SBR
Lane Configurations	↗	↑↑			↑↑	↗	↗	↖	↖			
Traffic Volume (veh/h)	121	1643	0	0	913	652	371	4	461	0	0	0
Future Volume (veh/h)	121	1643	0	0	913	652	371	4	461	0	0	0
Initial Q (Qb), veh	0	0	0	0	0	0	0	0	0			
Ped-Bike Adj(A_pbT)	1.00		1.00	1.00		1.00	1.00		1.00			
Parking Bus, Adj	1.00	1.00	1.00	1.00	1.00	1.00	1.00	1.00	1.00			
Work Zone On Approach		No			No			No				
Adj Sat Flow, veh/h/ln	1900	1900	0	0	1900	1900	1900	1900	1900			
Adj Flow Rate, veh/h	129	1748	0	0	971	544	398	0	409			
Peak Hour Factor	0.94	0.94	0.94	0.94	0.94	0.94	0.94	0.94	0.94			
Percent Heavy Veh, %	0	0	0	0	0	0	0	0	0			
Cap, veh/h	157	2220	0	0	1759	783	1015	0	452			
Arrive On Green	0.17	1.00	0.00	0.00	0.49	0.49	0.28	0.00	0.28			
Sat Flow, veh/h	1810	3705	0	0	3705	1607	3619	0	1610			
Grp Volume(v), veh/h	129	1748	0	0	971	544	398	0	409			
Grp Sat Flow(s),veh/h/ln	1810	1805	0	0	1805	1607	1810	0	1610			
Q Serve(g_s), s	7.6	0.0	0.0	0.0	20.8	28.9	9.8	0.0	27.0			
Cycle Q Clear(g_c), s	7.6	0.0	0.0	0.0	20.8	28.9	9.8	0.0	27.0			
Prop In Lane	1.00		0.00	0.00		1.00	1.00		1.00			
Lane Grp Cap(c), veh/h	157	2220	0	0	1759	783	1015	0	452			
V/C Ratio(X)	0.82	0.79	0.00	0.00	0.55	0.69	0.39	0.00	0.91			
Avail Cap(c_a), veh/h	304	2220	0	0	1759	783	1201	0	534			
HCM Platoon Ratio	2.00	2.00	1.00	1.00	1.00	1.00	1.00	1.00	1.00			
Upstream Filter(I)	0.14	0.14	0.00	0.00	1.00	1.00	1.00	0.00	1.00			
Uniform Delay (d), s/veh	44.6	0.0	0.0	0.0	19.8	21.9	32.0	0.0	38.2			
Incr Delay (d2), s/veh	1.6	0.4	0.0	0.0	1.3	5.0	0.2	0.0	17.2			
Initial Q Delay(d3),s/veh	0.0	0.0	0.0	0.0	0.0	0.0	0.0	0.0	0.0			
%ile BackOfQ(50%),veh/ln	3.1	0.1	0.0	0.0	8.2	10.8	4.2	0.0	12.3			
Unsig. Movement Delay, s/veh												
LnGrp Delay(d),s/veh	46.2	0.4	0.0	0.0	21.0	26.9	32.2	0.0	55.4			
LnGrp LOS	D	A	A	A	C	C	C	A	E			
Approach Vol, veh/h		1877			1515			807				
Approach Delay, s/veh		3.6			23.1			44.0				
Approach LOS		A			C			D				
Timer - Assigned Phs		2			5	6		8				
Phs Duration (G+Y+Rc), s		73.7			14.0	59.6		36.3				
Change Period (Y+Rc), s		6.0			4.5	6.0		5.5				
Max Green Setting (Gmax), s		62.0			18.5	39.0		36.5				
Max Q Clear Time (g_c+I1), s		2.0			9.6	30.9		29.0				
Green Ext Time (p_c), s		11.2			0.2	3.4		1.9				

Intersection Summary

HCM 6th Ctrl Delay	18.4
HCM 6th LOS	B

Notes

User approved volume balancing among the lanes for turning movement.

**APPENDIX 3.3: EXISTING (2022) CONDITIONS TRAFFIC SIGNAL  
WARRANT ANALYSIS WORKSHEETS**

This Page Intentionally Left Blank

### Figure 4C-4. Warrant 3, Peak Hour (70% Factor)

(COMMUNITY LESS THAN 10,000 POPULATION OR ABOVE 64 km/h OR ABOVE 40 mph ON MAJOR STREET)

Traffic Conditions = **Existing (2022) Conditions - Weekday PM Peak Hour**

Major Street Name = **Harvill Avenue**

Total of Both Approaches (VPH) = **722**  
 Number of Approach Lanes Major Street = **2**

Minor Street Name = **America's Tire**

High Volume Approach (VPH) = **6**  
 Number of Approach Lanes Minor Street = **1**

**SIGNAL WARRANT NOT SATISFIED**

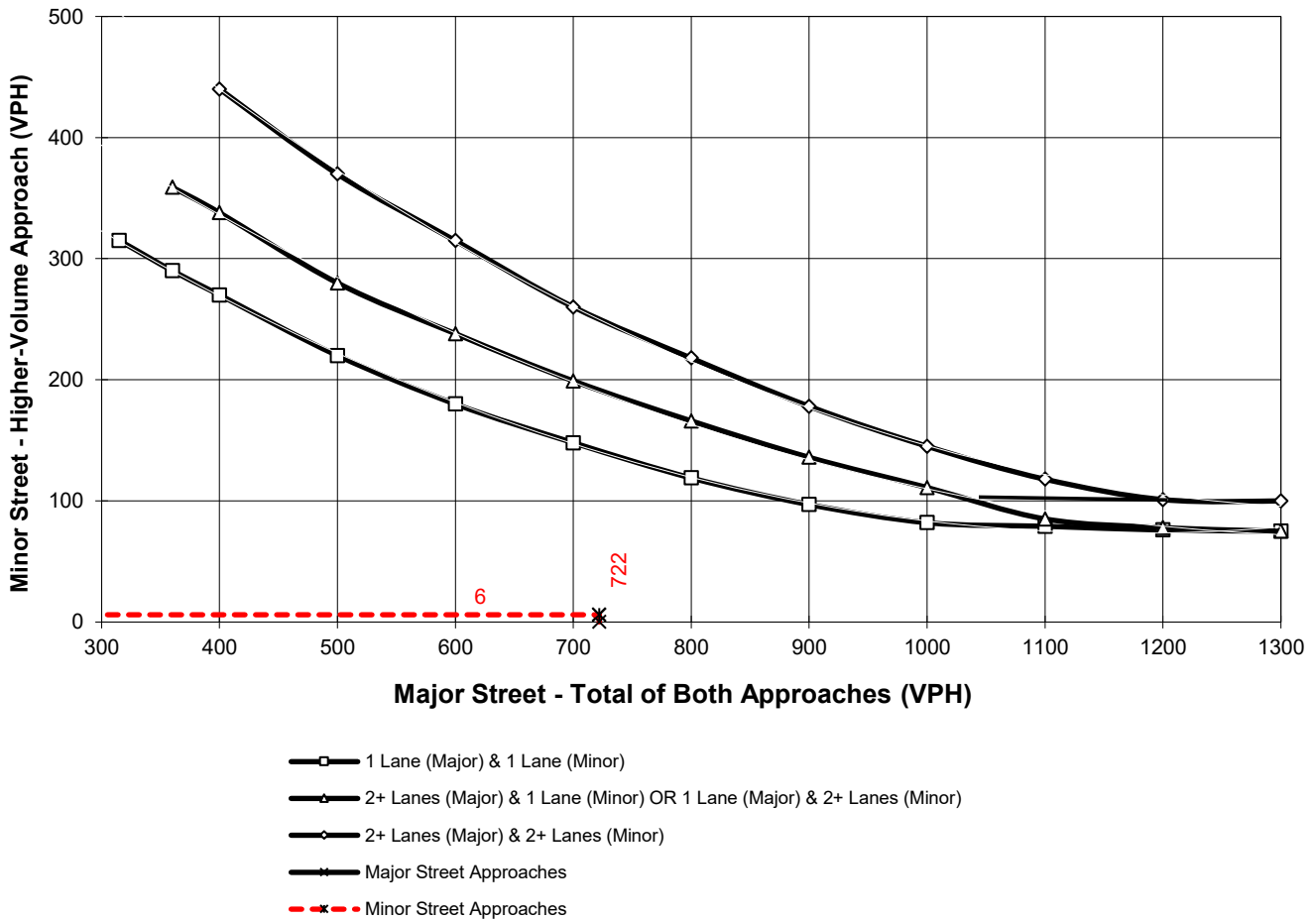

\*Note: 100 vph applies as the lower threshold for a minor-street approach with two or more lanes and 75 vph applies as the lower threshold for a minor-street approach with one lane



This Page Intentionally Left Blank



**APPENDIX 3.4: EXISTING (2022) CONDITIONS FREEWAY OFF-RAMP  
QUEUING ANALYSIS WORKSHEETS**

This Page Intentionally Left Blank

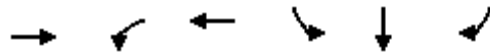

Lane Group	EBT	WBL	WBT	SBL	SBT	SBR
Lane Group Flow (vph)	1145	335	1144	417	419	214
v/c Ratio	0.92	0.93	0.54	0.80	0.80	0.39
Control Delay	44.6	48.7	4.4	48.2	48.3	20.4
Queue Delay	0.6	0.0	0.7	61.7	61.7	0.0
Total Delay	45.2	48.7	5.1	109.9	110.0	20.4
Queue Length 50th (ft)	383	93	54	284	285	70
Queue Length 95th (ft)	#523	m#346	24	#445	#448	138
Internal Link Dist (ft)	1408		344		1111	
Turn Bay Length (ft)		100		510		510
Base Capacity (vph)	1248	369	2133	522	523	549
Starvation Cap Reductn	0	0	579	0	0	0
Spillback Cap Reductn	14	0	0	325	326	0
Storage Cap Reductn	0	0	0	0	0	0
Reduced v/c Ratio	0.93	0.91	0.74	2.12	2.13	0.39

#### Intersection Summary

# 95th percentile volume exceeds capacity, queue may be longer.

Queue shown is maximum after two cycles.

m Volume for 95th percentile queue is metered by upstream signal.

Queues

5: I-215 NB Ramps & Ramona Exwy.



Lane Group	EBL	EBT	WBT	WBR	NBL	NBT	NBR
Lane Group Flow (vph)	164	1461	1084	763	205	209	631
v/c Ratio	0.68	0.72	0.77	0.76	0.36	0.37	1.08
Control Delay	42.4	28.0	34.7	12.0	30.2	30.3	92.3
Queue Delay	0.0	49.5	0.0	0.0	0.0	0.0	0.0
Total Delay	42.4	77.5	34.7	12.0	30.2	30.3	92.3
Queue Length 50th (ft)	120	576	349	76	114	117	~462
Queue Length 95th (ft)	m127	m634	457	268	184	187	#685
Internal Link Dist (ft)		344	532			1162	
Turn Bay Length (ft)	105			200			500
Base Capacity (vph)	303	2034	1403	1000	569	570	585
Starvation Cap Reductn	0	1006	0	0	0	0	0
Spillback Cap Reductn	0	0	0	0	0	0	0
Storage Cap Reductn	0	0	0	0	0	0	0
Reduced v/c Ratio	0.54	1.42	0.77	0.76	0.36	0.37	1.08

Intersection Summary

- ~ Volume exceeds capacity, queue is theoretically infinite.  
Queue shown is maximum after two cycles.
- # 95th percentile volume exceeds capacity, queue may be longer.  
Queue shown is maximum after two cycles.
- m Volume for 95th percentile queue is metered by upstream signal.

4: I-215 SB Ramps & Ramona Exwy.

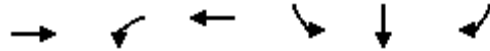

Lane Group	EBT	WBL	WBT	SBL	SBT	SBR
Lane Group Flow (vph)	1272	373	924	431	439	186
v/c Ratio	1.03	1.01	0.43	0.83	0.84	0.32
Control Delay	69.1	69.7	5.2	50.4	51.6	10.3
Queue Delay	12.9	0.0	0.4	72.5	72.1	0.0
Total Delay	82.0	69.7	5.6	122.9	123.7	10.3
Queue Length 50th (ft)	~494	~242	74	296	304	24
Queue Length 95th (ft)	#633	#441	22	#468	#481	78
Internal Link Dist (ft)	1408		344		1111	
Turn Bay Length (ft)		100		510		510
Base Capacity (vph)	1231	369	2133	522	523	588
Starvation Cap Reductn	0	0	659	0	0	0
Spillback Cap Reductn	40	0	0	414	415	0
Storage Cap Reductn	0	0	0	0	0	0
Reduced v/c Ratio	1.07	1.01	0.63	3.99	4.06	0.32

Intersection Summary

~ Volume exceeds capacity, queue is theoretically infinite.

Queue shown is maximum after two cycles.

# 95th percentile volume exceeds capacity, queue may be longer.

Queue shown is maximum after two cycles.

Queues

5: I-215 NB Ramps & Ramona Exwy.



Lane Group	EBL	EBT	WBT	WBR	NBL	NBT	NBR
Lane Group Flow (vph)	129	1748	971	694	197	202	490
v/c Ratio	0.60	0.82	0.62	0.67	0.38	0.39	0.91
Control Delay	39.1	30.9	28.0	7.4	31.7	31.9	52.7
Queue Delay	0.0	48.6	0.0	0.0	0.0	0.0	0.0
Total Delay	39.1	79.4	28.0	7.4	31.7	31.9	52.7
Queue Length 50th (ft)	88	664	289	32	109	112	276
Queue Length 95th (ft)	m82	m661	392	164	176	181	#457
Internal Link Dist (ft)		344	532			1162	
Turn Bay Length (ft)	105			200			500
Base Capacity (vph)	303	2139	1562	1038	569	570	585
Starvation Cap Reductn	0	992	0	0	0	0	0
Spillback Cap Reductn	0	0	0	0	0	0	0
Storage Cap Reductn	0	0	0	0	0	0	0
Reduced v/c Ratio	0.43	1.52	0.62	0.67	0.35	0.35	0.84

Intersection Summary

# 95th percentile volume exceeds capacity, queue may be longer.

Queue shown is maximum after two cycles.

m Volume for 95th percentile queue is metered by upstream signal.

## **APPENDIX 5.1: EAP (2025) CONDITIONS INTERSECTION OPERATIONS ANALYSIS WORKSHEETS**

This Page Intentionally Left Blank



Intersection						
Int Delay, s/veh	0					
Movement	WBL	WBR	NBT	NBR	SBL	SBT
Lane Configurations	↔		↑↓		↔	↑↑
Traffic Vol, veh/h	0	1	783	1	4	500
Future Vol, veh/h	0	1	783	1	4	500
Conflicting Peds, #/hr	0	0	0	0	0	0
Sign Control	Stop	Stop	Free	Free	Free	Free
RT Channelized	-	None	-	None	-	None
Storage Length	0	-	-	-	100	-
Veh in Median Storage, #	1	-	0	-	-	0
Grade, %	0	-	0	-	-	0
Peak Hour Factor	92	92	92	92	92	92
Heavy Vehicles, %	0	0	0	0	0	0
Mvmt Flow	0	1	851	1	4	543

Major/Minor	Minor1	Major1	Major2			
Conflicting Flow All	1132	426	0	0	852	0
Stage 1	852	-	-	-	-	-
Stage 2	280	-	-	-	-	-
Critical Hdwy	6.8	6.9	-	-	4.1	-
Critical Hdwy Stg 1	5.8	-	-	-	-	-
Critical Hdwy Stg 2	5.8	-	-	-	-	-
Follow-up Hdwy	3.5	3.3	-	-	2.2	-
Pot Cap-1 Maneuver	200	582	-	-	795	-
Stage 1	383	-	-	-	-	-
Stage 2	748	-	-	-	-	-
Platoon blocked, %			-	-	-	-
Mov Cap-1 Maneuver	199	582	-	-	795	-
Mov Cap-2 Maneuver	307	-	-	-	-	-
Stage 1	383	-	-	-	-	-
Stage 2	744	-	-	-	-	-

Approach	WB	NB	SB
HCM Control Delay, s	11.2	0	0.1
HCM LOS	B		

Minor Lane/Major Mvmt	NBT	NBRWBLn1	SBL	SBT
Capacity (veh/h)	-	-	582	795
HCM Lane V/C Ratio	-	-	0.002	0.005
HCM Control Delay (s)	-	-	11.2	9.6
HCM Lane LOS	-	-	B	A
HCM 95th %tile Q(veh)	-	-	0	0

Intersection						
Int Delay, s/veh	0.2					
Movement	WBL	WBR	NBT	NBR	SBL	SBT
Lane Configurations	↙	↗	↕↔		↙	↕↕
Traffic Vol, veh/h	3	5	479	9	10	290
Future Vol, veh/h	3	5	479	9	10	290
Conflicting Peds, #/hr	0	0	0	0	0	0
Sign Control	Stop	Stop	Free	Free	Free	Free
RT Channelized	-	None	-	None	-	None
Storage Length	0	0	-	-	130	-
Veh in Median Storage, #	1	-	0	-	-	0
Grade, %	0	-	0	-	-	0
Peak Hour Factor	94	94	94	94	94	94
Heavy Vehicles, %	0	0	0	0	0	0
Mvmt Flow	3	5	510	10	11	309

Major/Minor	Minor1	Major1	Major2			
Conflicting Flow All	692	260	0	0	520	0
Stage 1	515	-	-	-	-	-
Stage 2	177	-	-	-	-	-
Critical Hdwy	6.8	6.9	-	-	4.1	-
Critical Hdwy Stg 1	5.8	-	-	-	-	-
Critical Hdwy Stg 2	5.8	-	-	-	-	-
Follow-up Hdwy	3.5	3.3	-	-	2.2	-
Pot Cap-1 Maneuver	382	745	-	-	1056	-
Stage 1	570	-	-	-	-	-
Stage 2	842	-	-	-	-	-
Platoon blocked, %			-	-	-	-
Mov Cap-1 Maneuver	378	745	-	-	1056	-
Mov Cap-2 Maneuver	468	-	-	-	-	-
Stage 1	570	-	-	-	-	-
Stage 2	834	-	-	-	-	-

Approach	WB	NB	SB
HCM Control Delay, s	11	0	0.3
HCM LOS	B		

Minor Lane/Major Mvmt	NBT	NBR	WBLn1	WBLn2	SBL	SBT
Capacity (veh/h)	-	-	468	745	1056	-
HCM Lane V/C Ratio	-	-	0.007	0.007	0.01	-
HCM Control Delay (s)	-	-	12.7	9.9	8.4	-
HCM Lane LOS	-	-	B	A	A	-
HCM 95th %tile Q(veh)	-	-	0	0	0	-

Timings  
3: Harvill Av. & Cajalco Exwy./Ramona Exwy.

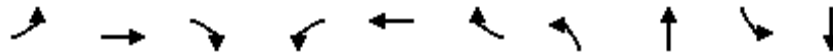

Lane Group	EBL	EBT	EBR	WBL	WBT	WBR	NBL	NBT	SBL	SBT
Lane Configurations	↖	↗	↘	↖	↗	↘	↖	↗	↘	↖
Traffic Volume (vph)	50	721	53	177	718	115	315	359	203	123
Future Volume (vph)	50	721	53	177	718	115	315	359	203	123
Turn Type	Prot	NA	Perm	Prot	NA	pm+ov	Prot	NA	Prot	NA
Protected Phases	5	2		1	6	7	3	8	7	4
Permitted Phases			2			6				
Detector Phase	5	2	2	1	6	7	3	8	7	4
Switch Phase										
Minimum Initial (s)	5.0	10.0	10.0	5.0	10.0	5.0	5.0	10.0	5.0	10.0
Minimum Split (s)	9.6	36.2	36.2	9.6	32.5	9.6	9.6	16.2	9.6	41.2
Total Split (s)	10.2	38.8	38.8	16.7	45.3	15.6	23.3	48.9	15.6	41.2
Total Split (%)	8.5%	32.3%	32.3%	13.9%	37.8%	13.0%	19.4%	40.8%	13.0%	34.3%
Yellow Time (s)	3.6	5.2	5.2	3.6	3.5	3.6	3.6	5.2	3.6	5.2
All-Red Time (s)	1.0	1.0	1.0	1.0	1.0	1.0	1.0	1.0	1.0	1.0
Lost Time Adjust (s)	0.0	0.0	0.0	0.0	0.0	0.0	0.0	0.0	0.0	0.0
Total Lost Time (s)	4.6	6.2	6.2	4.6	4.5	4.6	4.6	6.2	4.6	6.2
Lead/Lag	Lead	Lag	Lag	Lead	Lag	Lead	Lead	Lag	Lead	Lag
Lead-Lag Optimize?	Yes	Yes	Yes	Yes	Yes	Yes	Yes	Yes	Yes	Yes
Recall Mode	None	None	None	None	None	None	None	Max	None	Max
Act Effct Green (s)	5.5	29.1	29.1	10.2	37.6	52.2	15.1	42.9	10.1	37.9
Actuated g/C Ratio	0.05	0.26	0.26	0.09	0.33	0.46	0.13	0.38	0.09	0.33
v/c Ratio	0.62	0.84	0.10	0.61	0.65	0.15	0.73	0.35	0.70	0.14
Control Delay	85.4	49.8	0.4	59.5	35.9	3.6	57.8	26.0	64.1	25.0
Queue Delay	0.0	0.0	0.0	0.0	0.0	0.0	0.0	0.0	0.0	0.0
Total Delay	85.4	49.8	0.4	59.5	35.9	3.6	57.8	26.0	64.1	25.0
LOS	F	D	A	E	D	A	E	C	E	C
Approach Delay		48.8			36.4			39.3		47.4
Approach LOS		D			D			D		D

Intersection Summary

Cycle Length: 120  
 Actuated Cycle Length: 113.9  
 Natural Cycle: 100  
 Control Type: Actuated-Uncoordinated  
 Maximum v/c Ratio: 0.84  
 Intersection Signal Delay: 41.9  
 Intersection LOS: D  
 Intersection Capacity Utilization 61.2%  
 ICU Level of Service B  
 Analysis Period (min) 15

Splits and Phases: 3: Harvill Av. & Cajalco Exwy./Ramona Exwy.

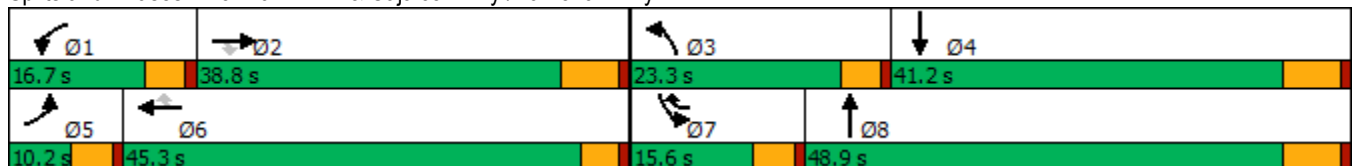

HCM 6th Signalized Intersection Summary  
 3: Harvill Av. & Cajalco Exwy./Ramona Exwy.

MFBC Building 17 (JN 13697)

09/23/2022



Movement	EBL	EBT	EBR	WBL	WBT	WBR	NBL	NBT	NBR	SBL	SBT	SBR
Lane Configurations	↘	↑↑	↗	↘↗	↑↑	↗	↘↗	↑↘		↘↗	↑↘	
Traffic Volume (veh/h)	50	721	53	177	718	115	315	359	80	203	123	28
Future Volume (veh/h)	50	721	53	177	718	115	315	359	80	203	123	28
Initial Q (Qb), veh	0	0	0	0	0	0	0	0	0	0	0	0
Ped-Bike Adj(A_pbT)	1.00		1.00	1.00		1.00	1.00		0.99	1.00		1.00
Parking Bus, Adj	1.00	1.00	1.00	1.00	1.00	1.00	1.00	1.00	1.00	1.00	1.00	1.00
Work Zone On Approach		No			No			No			No	
Adj Sat Flow, veh/h/ln	1900	1900	1900	1900	1900	1900	1900	1900	1900	1900	1900	1900
Adj Flow Rate, veh/h	54	775	6	190	772	56	339	386	32	218	132	28
Peak Hour Factor	0.93	0.93	0.93	0.93	0.93	0.93	0.93	0.93	0.93	0.93	0.93	0.93
Percent Heavy Veh, %	0	0	0	0	0	0	0	0	0	0	0	0
Cap, veh/h	70	907	405	254	1030	588	408	1335	110	281	1071	222
Arrive On Green	0.04	0.25	0.25	0.07	0.29	0.29	0.12	0.40	0.40	0.08	0.36	0.36
Sat Flow, veh/h	1810	3610	1610	3510	3610	1610	3510	3373	278	3510	2978	616
Grp Volume(v), veh/h	54	775	6	190	772	56	339	206	212	218	79	81
Grp Sat Flow(s),veh/h/ln	1810	1805	1610	1755	1805	1610	1755	1805	1846	1755	1805	1789
Q Serve(g_s), s	3.2	22.1	0.3	5.7	21.0	2.5	10.2	8.4	8.5	6.6	3.1	3.3
Cycle Q Clear(g_c), s	3.2	22.1	0.3	5.7	21.0	2.5	10.2	8.4	8.5	6.6	3.1	3.3
Prop In Lane	1.00		1.00	1.00		1.00	1.00		0.15	1.00		0.34
Lane Grp Cap(c), veh/h	70	907	405	254	1030	588	408	714	731	281	649	644
V/C Ratio(X)	0.77	0.85	0.01	0.75	0.75	0.10	0.83	0.29	0.29	0.77	0.12	0.13
Avail Cap(c_a), veh/h	94	1091	487	394	1365	738	609	714	731	358	649	644
HCM Platoon Ratio	1.00	1.00	1.00	1.00	1.00	1.00	1.00	1.00	1.00	1.00	1.00	1.00
Upstream Filter(I)	1.00	1.00	1.00	1.00	1.00	1.00	1.00	1.00	1.00	1.00	1.00	1.00
Uniform Delay (d), s/veh	51.4	38.5	30.3	49.1	35.1	22.5	46.6	22.2	22.3	48.7	23.1	23.2
Incr Delay (d2), s/veh	16.5	5.8	0.0	1.6	1.6	0.1	3.8	1.0	1.0	5.8	0.4	0.4
Initial Q Delay(d3),s/veh	0.0	0.0	0.0	0.0	0.0	0.0	0.0	0.0	0.0	0.0	0.0	0.0
%ile BackOfQ(50%),veh/ln	1.7	9.9	0.1	2.5	8.9	0.9	4.5	3.5	3.6	3.0	1.3	1.4
Unsig. Movement Delay, s/veh												
LnGrp Delay(d),s/veh	67.9	44.3	30.4	50.7	36.7	22.6	50.4	23.2	23.3	54.5	23.5	23.6
LnGrp LOS	E	D	C	D	D	C	D	C	C	D	C	C
Approach Vol, veh/h		835			1018			757				378
Approach Delay, s/veh		45.8			38.5			35.4				41.4
Approach LOS		D			D			D				D
Timer - Assigned Phs	1	2	3	4	5	6	7	8				
Phs Duration (G+Y+Rc), s	12.4	33.3	17.1	45.0	8.8	37.0	13.2	48.9				
Change Period (Y+Rc), s	4.6	6.2	4.6	6.2	4.6	* 6.2	4.6	6.2				
Max Green Setting (Gmax), s	12.1	32.6	18.7	35.0	5.6	* 41	11.0	42.7				
Max Q Clear Time (g_c+I1), s	7.7	24.1	12.2	5.3	5.2	23.0	8.6	10.5				
Green Ext Time (p_c), s	0.1	3.0	0.4	0.7	0.0	4.6	0.1	2.2				

Intersection Summary

HCM 6th Ctrl Delay	40.1
HCM 6th LOS	D

Notes

\* HCM 6th computational engine requires equal clearance times for the phases crossing the barrier.

Timings  
4: I-215 SB Ramps & Ramona Exwy.

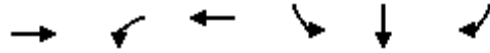

Lane Group	EBT	WBL	WBT	SBL	SBT	SBR
Lane Configurations	↑↑	↑	↑↑	↑	↑	↑
Traffic Volume (vph)	414	280	958	843	2	167
Future Volume (vph)	414	280	958	843	2	167
Turn Type	NA	Prot	NA	Split	NA	Perm
Protected Phases	2	1	6	4	4	
Permitted Phases						4
Detector Phase	2	1	6	4	4	4
Switch Phase						
Minimum Initial (s)	5.0	5.0	5.0	5.0	5.0	5.0
Minimum Split (s)	11.0	9.5	31.0	10.5	10.5	10.5
Total Split (s)	44.0	27.0	71.0	39.0	39.0	39.0
Total Split (%)	40.0%	24.5%	64.5%	35.5%	35.5%	35.5%
Yellow Time (s)	5.0	3.5	5.0	4.5	4.5	4.5
All-Red Time (s)	1.0	1.0	1.0	1.0	1.0	1.0
Lost Time Adjust (s)	0.0	0.0	0.0	0.0	0.0	0.0
Total Lost Time (s)	6.0	4.5	6.0	5.5	5.5	5.5
Lead/Lag	Lag	Lead				
Lead-Lag Optimize?	Yes	Yes				
Recall Mode	C-Max	None	C-Max	Max	Max	Max
Act Effct Green (s)	39.8	20.7	65.0	33.5	33.5	33.5
Actuated g/C Ratio	0.36	0.19	0.59	0.30	0.30	0.30
v/c Ratio	0.54	0.84	0.46	0.82	0.83	0.29
Control Delay	22.6	40.2	5.6	50.2	50.4	10.9
Queue Delay	0.0	0.0	0.5	53.1	53.0	0.0
Total Delay	22.6	40.2	6.1	103.3	103.4	10.9
LOS	C	D	A	F	F	B
Approach Delay	22.6		13.8		88.1	
Approach LOS	C		B		F	

Intersection Summary

Cycle Length: 110  
 Actuated Cycle Length: 110  
 Offset: 34 (31%), Referenced to phase 2:EBT and 6:WBT, Start of Yellow  
 Natural Cycle: 60  
 Control Type: Actuated-Coordinated  
 Maximum v/c Ratio: 0.84  
 Intersection Signal Delay: 41.4  
 Intersection LOS: D  
 Intersection Capacity Utilization 120.3%  
 ICU Level of Service H  
 Analysis Period (min) 15

Splits and Phases: 4: I-215 SB Ramps & Ramona Exwy.



HCM 6th Signalized Intersection Summary  
 4: I-215 SB Ramps & Ramona Exwy.

MFBC Building 17 (JN 13697)

09/23/2022



Movement	EBL	EBT	EBR	WBL	WBT	WBR	NBL	NBT	NBR	SBL	SBT	SBR
Lane Configurations		↑↑		↖	↑↑					↖	↑	↖
Traffic Volume (veh/h)	0	414	292	280	958	0	0	0	0	843	2	167
Future Volume (veh/h)	0	414	292	280	958	0	0	0	0	843	2	167
Initial Q (Qb), veh	0	0	0	0	0	0				0	0	0
Ped-Bike Adj(A_pbT)	1.00		0.99	1.00		1.00				1.00		1.00
Parking Bus, Adj	1.00	1.00	1.00	1.00	1.00	1.00				1.00	1.00	1.00
Work Zone On Approach		No			No						No	
Adj Sat Flow, veh/h/ln	0	1900	1900	1900	1900	0				1900	1900	1900
Adj Flow Rate, veh/h	0	422	169	286	978	0				861	0	107
Peak Hour Factor	0.98	0.98	0.98	0.98	0.98	0.98				0.98	0.98	0.98
Percent Heavy Veh, %	0	0	0	0	0	0				0	0	0
Cap, veh/h	0	939	372	320	2133	0				1102	0	490
Arrive On Green	0.00	0.37	0.37	0.11	0.35	0.00				0.30	0.00	0.30
Sat Flow, veh/h	0	2610	996	1810	3705	0				3619	0	1610
Grp Volume(v), veh/h	0	302	289	286	978	0				861	0	107
Grp Sat Flow(s),veh/h/ln	0	1805	1706	1810	1805	0				1810	0	1610
Q Serve(g_s), s	0.0	13.8	14.1	17.2	23.0	0.0				23.9	0.0	5.4
Cycle Q Clear(g_c), s	0.0	13.8	14.1	17.2	23.0	0.0				23.9	0.0	5.4
Prop In Lane	0.00		0.58	1.00		0.00				1.00		1.00
Lane Grp Cap(c), veh/h	0	674	637	320	2133	0				1102	0	490
V/C Ratio(X)	0.00	0.45	0.45	0.89	0.46	0.00				0.78	0.00	0.22
Avail Cap(c_a), veh/h	0	674	637	370	2133	0				1102	0	490
HCM Platoon Ratio	1.00	1.00	1.00	0.60	0.60	1.00				1.00	1.00	1.00
Upstream Filter(I)	0.00	0.48	0.48	0.80	0.80	0.00				1.00	0.00	1.00
Uniform Delay (d), s/veh	0.0	25.9	26.0	48.2	21.9	0.0				34.9	0.0	28.5
Incr Delay (d2), s/veh	0.0	1.0	1.1	17.9	0.6	0.0				5.5	0.0	1.0
Initial Q Delay(d3),s/veh	0.0	0.0	0.0	0.0	0.0	0.0				0.0	0.0	0.0
%ile BackOfQ(50%),veh/ln	0.0	5.8	5.6	9.5	10.4	0.0				10.8	0.0	2.2
Unsig. Movement Delay, s/veh												
LnGrp Delay(d),s/veh	0.0	27.0	27.1	66.0	22.5	0.0				40.4	0.0	29.5
LnGrp LOS	A	C	C	E	C	A				D	A	C
Approach Vol, veh/h		591			1264						968	
Approach Delay, s/veh		27.1			32.4						39.2	
Approach LOS		C			C						D	
Timer - Assigned Phs	1	2		4		6						
Phs Duration (G+Y+Rc), s	23.9	47.1		39.0		71.0						
Change Period (Y+Rc), s	4.5	6.0		5.5		6.0						
Max Green Setting (Gmax), s	22.5	38.0		33.5		65.0						
Max Q Clear Time (g_c+I1), s	19.2	16.1		25.9		25.0						
Green Ext Time (p_c), s	0.3	1.9		2.4		4.3						

Intersection Summary

HCM 6th Ctrl Delay	33.6
HCM 6th LOS	C

Notes

User approved volume balancing among the lanes for turning movement.

Timings  
5: I-215 NB Ramps & Ramona Exwy.



Lane Group	EBL	EBT	WBT	WBR	NBL	NBT	NBR
Lane Configurations	↶	↷	↶	↷	↶	↷	↷
Traffic Volume (vph)	126	1136	917	589	322	4	487
Future Volume (vph)	126	1136	917	589	322	4	487
Turn Type	Prot	NA	NA	Perm	Split	NA	Perm
Protected Phases	5	2	6		8	8	
Permitted Phases				6			8
Detector Phase	5	2	6	6	8	8	8
Switch Phase							
Minimum Initial (s)	5.0	5.0	5.0	5.0	5.0	5.0	5.0
Minimum Split (s)	9.5	11.0	26.0	26.0	10.5	10.5	10.5
Total Split (s)	23.0	68.0	45.0	45.0	42.0	42.0	42.0
Total Split (%)	20.9%	61.8%	40.9%	40.9%	38.2%	38.2%	38.2%
Yellow Time (s)	3.5	5.0	5.0	5.0	4.5	4.5	4.5
All-Red Time (s)	1.0	1.0	1.0	1.0	1.0	1.0	1.0
Lost Time Adjust (s)	0.0	0.0	0.0	0.0	0.0	0.0	0.0
Total Lost Time (s)	4.5	6.0	6.0	6.0	5.5	5.5	5.5
Lead/Lag	Lead		Lag	Lag			
Lead-Lag Optimize?	Yes		Yes	Yes			
Recall Mode	None	C-Max	C-Max	C-Max	None	None	None
Act Effct Green (s)	13.2	64.8	47.1	47.1	33.7	33.7	33.7
Actuated g/C Ratio	0.12	0.59	0.43	0.43	0.31	0.31	0.31
v/c Ratio	0.60	0.55	0.61	0.60	0.32	0.32	0.92
Control Delay	50.7	14.1	27.9	6.2	30.4	30.3	54.5
Queue Delay	0.0	24.6	0.0	0.0	0.0	0.0	0.0
Total Delay	50.7	38.7	27.9	6.2	30.4	30.3	54.5
LOS	D	D	C	A	C	C	D
Approach Delay		39.9	19.4			44.8	
Approach LOS		D	B			D	

Intersection Summary

Cycle Length: 110  
 Actuated Cycle Length: 110  
 Offset: 0 (0%), Referenced to phase 2:EBT and 6:WBT, Start of Yellow, Master Intersection  
 Natural Cycle: 60  
 Control Type: Actuated-Coordinated  
 Maximum v/c Ratio: 0.92  
 Intersection Signal Delay: 32.4  
 Intersection LOS: C  
 Intersection Capacity Utilization 120.3%  
 ICU Level of Service H  
 Analysis Period (min) 15



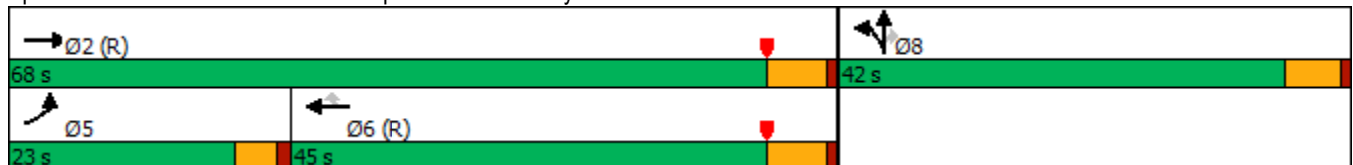















Splits and Phases: 5: I-215 NB Ramps & Ramona Exwy.



HCM 6th Signalized Intersection Summary  
 5: I-215 NB Ramps & Ramona Exwy.

MFBC Building 17 (JN 13697)

09/23/2022

												
Movement	EBL	EBT	EBR	WBL	WBT	WBR	NBL	NBT	NBR	SBL	SBT	SBR
Lane Configurations												
Traffic Volume (veh/h)	126	1136	0	0	917	589	322	4	487	0	0	0
Future Volume (veh/h)	126	1136	0	0	917	589	322	4	487	0	0	0
Initial Q (Qb), veh	0	0	0	0	0	0	0	0	0			
Ped-Bike Adj(A_pbT)	1.00		1.00	1.00		1.00	1.00		1.00			
Parking Bus, Adj	1.00	1.00	1.00	1.00	1.00	1.00	1.00	1.00	1.00			
Work Zone On Approach		No			No			No				
Adj Sat Flow, veh/h/ln	1900	1900	0	0	1900	1900	1900	1900	1900			
Adj Flow Rate, veh/h	130	1171	0	0	945	459	335	0	350			
Peak Hour Factor	0.97	0.97	0.97	0.97	0.97	0.97	0.97	0.97	0.97			
Percent Heavy Veh, %	0	0	0	0	0	0	0	0	0			
Cap, veh/h	158	2347	0	0	1884	840	888	0	395			
Arrive On Green	0.17	1.00	0.00	0.00	0.52	0.52	0.25	0.00	0.25			
Sat Flow, veh/h	1810	3705	0	0	3705	1610	3619	0	1610			
Grp Volume(v), veh/h	130	1171	0	0	945	459	335	0	350			
Grp Sat Flow(s),veh/h/ln	1810	1805	0	0	1805	1610	1810	0	1610			
Q Serve(g_s), s	7.6	0.0	0.0	0.0	18.7	21.0	8.5	0.0	23.1			
Cycle Q Clear(g_c), s	7.6	0.0	0.0	0.0	18.7	21.0	8.5	0.0	23.1			
Prop In Lane	1.00		0.00	0.00		1.00	1.00		1.00			
Lane Grp Cap(c), veh/h	158	2347	0	0	1884	840	888	0	395			
V/C Ratio(X)	0.82	0.50	0.00	0.00	0.50	0.55	0.38	0.00	0.89			
Avail Cap(c_a), veh/h	304	2347	0	0	1884	840	1201	0	534			
HCM Platoon Ratio	2.00	2.00	1.00	1.00	1.00	1.00	1.00	1.00	1.00			
Upstream Filter(I)	0.72	0.72	0.00	0.00	1.00	1.00	1.00	0.00	1.00			
Uniform Delay (d), s/veh	44.6	0.0	0.0	0.0	17.0	17.6	34.5	0.0	40.0			
Incr Delay (d2), s/veh	7.5	0.5	0.0	0.0	1.0	2.5	0.3	0.0	13.0			
Initial Q Delay(d3),s/veh	0.0	0.0	0.0	0.0	0.0	0.0	0.0	0.0	0.0			
%ile BackOfQ(50%),veh/ln	3.4	0.2	0.0	0.0	7.2	7.5	3.6	0.0	10.1			
Unsig. Movement Delay, s/veh												
LnGrp Delay(d),s/veh	52.1	0.5	0.0	0.0	18.0	20.1	34.8	0.0	53.0			
LnGrp LOS	D	A	A	A	B	C	C	A	D			
Approach Vol, veh/h		1301			1404			685				
Approach Delay, s/veh		5.7			18.7			44.1				
Approach LOS		A			B			D				
Timer - Assigned Phs		2			5	6		8				
Phs Duration (G+Y+Rc), s		77.5			14.1	63.4		32.5				
Change Period (Y+Rc), s		6.0			4.5	6.0		5.5				
Max Green Setting (Gmax), s		62.0			18.5	39.0		36.5				
Max Q Clear Time (g_c+I1), s		2.0			9.6	23.0		25.1				
Green Ext Time (p_c), s		5.6			0.2	4.4		1.9				

Intersection Summary

HCM 6th Ctrl Delay	18.8
HCM 6th LOS	B

Notes

User approved volume balancing among the lanes for turning movement.



Intersection						
Int Delay, s/veh	0.1					
Movement	WBL	WBR	NBT	NBR	SBL	SBT
Lane Configurations	Y		↑↑		Y	↑↑
Traffic Vol, veh/h	2	5	588	1	2	691
Future Vol, veh/h	2	5	588	1	2	691
Conflicting Peds, #/hr	0	0	0	0	0	0
Sign Control	Stop	Stop	Free	Free	Free	Free
RT Channelized	-	None	-	None	-	None
Storage Length	0	-	-	-	100	-
Veh in Median Storage, #	0	-	0	-	-	0
Grade, %	0	-	0	-	-	0
Peak Hour Factor	92	92	92	92	92	92
Heavy Vehicles, %	0	0	0	0	0	0
Mvmt Flow	2	5	639	1	2	751

Major/Minor	Minor1	Major1	Major2		
Conflicting Flow All	1020	320	0	0	640
Stage 1	640	-	-	-	-
Stage 2	380	-	-	-	-
Critical Hdwy	6.8	6.9	-	-	4.1
Critical Hdwy Stg 1	5.8	-	-	-	-
Critical Hdwy Stg 2	5.8	-	-	-	-
Follow-up Hdwy	3.5	3.3	-	-	2.2
Pot Cap-1 Maneuver	236	682	-	-	954
Stage 1	493	-	-	-	-
Stage 2	667	-	-	-	-
Platoon blocked, %			-	-	-
Mov Cap-1 Maneuver	236	682	-	-	954
Mov Cap-2 Maneuver	362	-	-	-	-
Stage 1	493	-	-	-	-
Stage 2	666	-	-	-	-

Approach	WB	NB	SB
HCM Control Delay, s	11.7	0	0
HCM LOS	B		

Minor Lane/Major Mvmt	NBT	NBRWBLn1	SBL	SBT
Capacity (veh/h)	-	-	544	954
HCM Lane V/C Ratio	-	-	0.014	0.002
HCM Control Delay (s)	-	-	11.7	8.8
HCM Lane LOS	-	-	B	A
HCM 95th %tile Q(veh)	-	-	0	0

Intersection						
Int Delay, s/veh	0.3					
Movement	WBL	WBR	NBT	NBR	SBL	SBT
Lane Configurations	↵	↶	↕↶		↵	↕↕
Traffic Vol, veh/h	10	11	378	5	3	390
Future Vol, veh/h	10	11	378	5	3	390
Conflicting Peds, #/hr	0	0	0	0	0	0
Sign Control	Stop	Stop	Free	Free	Free	Free
RT Channelized	-	None	-	None	-	None
Storage Length	0	0	-	-	130	-
Veh in Median Storage, #	1	-	0	-	-	0
Grade, %	0	-	0	-	-	0
Peak Hour Factor	90	90	90	90	90	90
Heavy Vehicles, %	0	0	0	0	0	0
Mvmt Flow	11	12	420	6	3	433

Major/Minor	Minor1	Major1	Major2		
Conflicting Flow All	646	213	0	0	426
Stage 1	423	-	-	-	-
Stage 2	223	-	-	-	-
Critical Hdwy	6.8	6.9	-	-	4.1
Critical Hdwy Stg 1	5.8	-	-	-	-
Critical Hdwy Stg 2	5.8	-	-	-	-
Follow-up Hdwy	3.5	3.3	-	-	2.2
Pot Cap-1 Maneuver	409	798	-	-	1144
Stage 1	635	-	-	-	-
Stage 2	799	-	-	-	-
Platoon blocked, %			-	-	-
Mov Cap-1 Maneuver	408	798	-	-	1144
Mov Cap-2 Maneuver	503	-	-	-	-
Stage 1	635	-	-	-	-
Stage 2	797	-	-	-	-

Approach	WB	NB	SB
HCM Control Delay, s	10.9	0	0.1
HCM LOS	B		

Minor Lane/Major Mvmt	NBT	NBR	WBLn1	WBLn2	SBL	SBT
Capacity (veh/h)	-	-	503	798	1144	-
HCM Lane V/C Ratio	-	-	0.022	0.015	0.003	-
HCM Control Delay (s)	-	-	12.3	9.6	8.2	-
HCM Lane LOS	-	-	B	A	A	-
HCM 95th %tile Q(veh)	-	-	0.1	0	0	-

Timings  
3: Harvill Av. & Cajalco Exwy./Ramona Exwy.

MFBC Building 17 (JN 13697)

09/23/2022

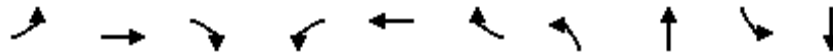

Lane Group	EBL	EBT	EBR	WBL	WBT	WBR	NBL	NBT	SBL	SBT
Lane Configurations	↙	↕	↘	↙↘	↕	↘	↙↘	↕	↙↘	↕
Traffic Volume (vph)	26	767	220	140	676	201	175	154	243	227
Future Volume (vph)	26	767	220	140	676	201	175	154	243	227
Turn Type	Prot	NA	Perm	Prot	NA	pm+ov	Prot	NA	Prot	NA
Protected Phases	5	2		1	6	7	3	8	7	4
Permitted Phases			2			6				
Detector Phase	5	2	2	1	6	7	3	8	7	4
Switch Phase										
Minimum Initial (s)	5.0	10.0	10.0	5.0	10.0	5.0	5.0	10.0	5.0	10.0
Minimum Split (s)	9.6	36.2	36.2	9.6	32.5	9.6	9.6	16.2	9.6	41.2
Total Split (s)	10.2	38.8	38.8	16.7	45.3	15.6	23.3	48.9	15.6	41.2
Total Split (%)	8.5%	32.3%	32.3%	13.9%	37.8%	13.0%	19.4%	40.8%	13.0%	34.3%
Yellow Time (s)	3.6	5.2	5.2	3.6	3.5	3.6	3.6	5.2	3.6	5.2
All-Red Time (s)	1.0	1.0	1.0	1.0	1.0	1.0	1.0	1.0	1.0	1.0
Lost Time Adjust (s)	0.0	0.0	0.0	0.0	0.0	0.0	0.0	0.0	0.0	0.0
Total Lost Time (s)	4.6	6.2	6.2	4.6	4.5	4.6	4.6	6.2	4.6	6.2
Lead/Lag	Lead	Lag	Lag	Lead	Lag	Lead	Lead	Lag	Lead	Lag
Lead-Lag Optimize?	Yes	Yes	Yes	Yes	Yes	Yes	Yes	Yes	Yes	Yes
Recall Mode	None	None	None	None	None	None	None	Max	None	Max
Act Effct Green (s)	5.4	30.4	30.4	9.3	40.1	55.2	10.6	42.8	10.7	42.9
Actuated g/C Ratio	0.05	0.26	0.26	0.08	0.35	0.48	0.09	0.37	0.09	0.37
v/c Ratio	0.33	0.86	0.39	0.54	0.58	0.24	0.58	0.23	0.80	0.22
Control Delay	65.3	50.9	6.3	58.4	33.3	3.1	58.0	14.1	70.8	24.9
Queue Delay	0.0	0.0	0.0	0.0	0.0	0.0	0.0	0.0	0.0	0.0
Total Delay	65.3	50.9	6.3	58.4	33.3	3.1	58.0	14.1	70.8	24.9
LOS	E	D	A	E	C	A	E	B	E	C
Approach Delay		41.6			30.8			30.7		46.8
Approach LOS		D			C			C		D

Intersection Summary

Cycle Length: 120  
 Actuated Cycle Length: 114.8  
 Natural Cycle: 100  
 Control Type: Actuated-Uncoordinated  
 Maximum v/c Ratio: 0.86  
 Intersection Signal Delay: 37.1  
 Intersection LOS: D  
 Intersection Capacity Utilization 58.8%  
 ICU Level of Service B  
 Analysis Period (min) 15

Splits and Phases: 3: Harvill Av. & Cajalco Exwy./Ramona Exwy.

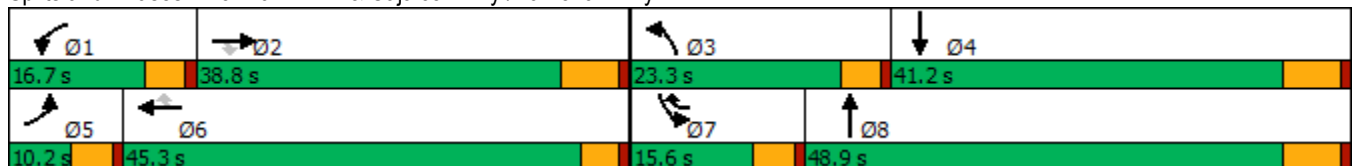

HCM 6th Signalized Intersection Summary  
 3: Harvill Av. & Cajalco Exwy./Ramona Exwy.

MFBC Building 17 (JN 13697)

09/23/2022



Movement	EBL	EBT	EBR	WBL	WBT	WBR	NBL	NBT	NBR	SBL	SBT	SBR
Lane Configurations	↘	↑↑	↗	↘↗	↑↑	↗	↘↗	↑↗		↘↗	↑↗	
Traffic Volume (veh/h)	26	767	220	140	676	201	175	154	132	243	227	39
Future Volume (veh/h)	26	767	220	140	676	201	175	154	132	243	227	39
Initial Q (Qb), veh	0	0	0	0	0	0	0	0	0	0	0	0
Ped-Bike Adj(A_pbT)	1.00		1.00	1.00		1.00	1.00		1.00	1.00		1.00
Parking Bus, Adj	1.00	1.00	1.00	1.00	1.00	1.00	1.00	1.00	1.00	1.00	1.00	1.00
Work Zone On Approach		No			No			No			No	
Adj Sat Flow, veh/h/ln	1900	1900	1900	1900	1900	1900	1900	1900	1900	1900	1900	1900
Adj Flow Rate, veh/h	28	825	124	151	727	136	188	166	74	261	244	31
Peak Hour Factor	0.93	0.93	0.93	0.93	0.93	0.93	0.93	0.93	0.93	0.93	0.93	0.93
Percent Heavy Veh, %	0	0	0	0	0	0	0	0	0	0	0	0
Cap, veh/h	47	950	424	213	1075	627	254	956	409	322	1315	165
Arrive On Green	0.03	0.26	0.26	0.06	0.30	0.30	0.07	0.39	0.39	0.09	0.41	0.41
Sat Flow, veh/h	1810	3610	1610	3510	3610	1610	3510	2463	1052	3510	3227	405
Grp Volume(v), veh/h	28	825	124	151	727	136	188	120	120	261	135	140
Grp Sat Flow(s),veh/h/ln	1810	1805	1610	1755	1805	1610	1755	1805	1711	1755	1805	1827
Q Serve(g_s), s	1.7	24.0	6.8	4.6	19.5	6.2	5.8	4.8	5.1	8.0	5.3	5.4
Cycle Q Clear(g_c), s	1.7	24.0	6.8	4.6	19.5	6.2	5.8	4.8	5.1	8.0	5.3	5.4
Prop In Lane	1.00		1.00	1.00		1.00	1.00		0.62	1.00		0.22
Lane Grp Cap(c), veh/h	47	950	424	213	1075	627	254	701	664	322	735	744
V/C Ratio(X)	0.59	0.87	0.29	0.71	0.68	0.22	0.74	0.17	0.18	0.81	0.18	0.19
Avail Cap(c_a), veh/h	92	1070	477	386	1339	745	597	701	664	351	735	744
HCM Platoon Ratio	1.00	1.00	1.00	1.00	1.00	1.00	1.00	1.00	1.00	1.00	1.00	1.00
Upstream Filter(I)	1.00	1.00	1.00	1.00	1.00	1.00	1.00	1.00	1.00	1.00	1.00	1.00
Uniform Delay (d), s/veh	53.0	38.7	32.4	50.7	34.0	22.4	50.0	22.0	22.1	49.0	20.9	20.9
Incr Delay (d2), s/veh	4.3	7.2	0.4	1.6	1.0	0.2	1.6	0.5	0.6	11.2	0.6	0.6
Initial Q Delay(d3),s/veh	0.0	0.0	0.0	0.0	0.0	0.0	0.0	0.0	0.0	0.0	0.0	0.0
%ile BackOfQ(50%),veh/ln	0.8	11.0	2.6	2.0	8.2	2.2	2.5	2.0	2.0	3.9	2.2	2.3
Unsig. Movement Delay, s/veh												
LnGrp Delay(d),s/veh	57.3	45.9	32.7	52.3	35.0	22.6	51.6	22.6	22.7	60.3	21.4	21.5
LnGrp LOS	E	D	C	D	C	C	D	C	C	E	C	C
Approach Vol, veh/h		977			1014			428			536	
Approach Delay, s/veh		44.5			35.9			35.4			40.4	
Approach LOS		D			D			D			D	
Timer - Assigned Phs	1	2	3	4	5	6	7	8				
Phs Duration (G+Y+Rc), s	11.3	35.1	12.6	51.0	7.5	38.9	14.7	48.9				
Change Period (Y+Rc), s	4.6	6.2	4.6	6.2	4.6	* 6.2	4.6	6.2				
Max Green Setting (Gmax), s	12.1	32.6	18.7	35.0	5.6	* 41	11.0	42.7				
Max Q Clear Time (g_c+I1), s	6.6	26.0	7.8	7.4	3.7	21.5	10.0	7.1				
Green Ext Time (p_c), s	0.1	2.9	0.2	1.3	0.0	4.7	0.1	1.2				

Intersection Summary

HCM 6th Ctrl Delay	39.5
HCM 6th LOS	D

Notes

\* HCM 6th computational engine requires equal clearance times for the phases crossing the barrier.

Timings  
4: I-215 SB Ramps & Ramona Exwy.

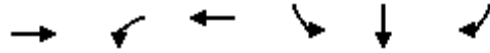

Lane Group	EBT	WBL	WBT	SBL	SBT	SBR
Lane Configurations	↑↑	↵	↑↑	↵	↵	↵
Traffic Volume (vph)	634	322	748	802	8	146
Future Volume (vph)	634	322	748	802	8	146
Turn Type	NA	Prot	NA	Split	NA	Perm
Protected Phases	2	1	6	4	4	
Permitted Phases						4
Detector Phase	2	1	6	4	4	4
Switch Phase						
Minimum Initial (s)	5.0	5.0	5.0	5.0	5.0	5.0
Minimum Split (s)	11.0	9.5	31.0	10.5	10.5	10.5
Total Split (s)	44.0	27.0	71.0	39.0	39.0	39.0
Total Split (%)	40.0%	24.5%	64.5%	35.5%	35.5%	35.5%
Yellow Time (s)	5.0	3.5	5.0	4.5	4.5	4.5
All-Red Time (s)	1.0	1.0	1.0	1.0	1.0	1.0
Lost Time Adjust (s)	0.0	0.0	0.0	0.0	0.0	0.0
Total Lost Time (s)	6.0	4.5	6.0	5.5	5.5	5.5
Lead/Lag	Lag	Lead				
Lead-Lag Optimize?	Yes	Yes				
Recall Mode	C-Max	None	C-Max	Max	Max	Max
Act Effct Green (s)	38.7	21.8	65.0	33.5	33.5	33.5
Actuated g/C Ratio	0.35	0.20	0.59	0.30	0.30	0.30
v/c Ratio	0.74	0.91	0.35	0.78	0.79	0.25
Control Delay	33.0	51.8	6.7	46.5	47.5	5.8
Queue Delay	0.0	0.0	0.3	55.8	55.6	0.0
Total Delay	33.1	51.8	7.0	102.4	103.0	5.8
LOS	C	D	A	F	F	A
Approach Delay	33.1		20.5		87.9	
Approach LOS	C		C		F	

Intersection Summary

Cycle Length: 110  
 Actuated Cycle Length: 110  
 Offset: 34 (31%), Referenced to phase 2:EBT and 6:WBT, Start of Yellow  
 Natural Cycle: 70  
 Control Type: Actuated-Coordinated  
 Maximum v/c Ratio: 0.91  
 Intersection Signal Delay: 46.3  
 Intersection LOS: D  
 Intersection Capacity Utilization 113.7%  
 ICU Level of Service H  
 Analysis Period (min) 15

Splits and Phases: 4: I-215 SB Ramps & Ramona Exwy.



HCM 6th Signalized Intersection Summary  
 4: I-215 SB Ramps & Ramona Exwy.

MFBC Building 17 (JN 13697)

09/23/2022



Movement	EBL	EBT	EBR	WBL	WBT	WBR	NBL	NBT	NBR	SBL	SBT	SBR
Lane Configurations		↑↑		↔	↑↑					↔	↑↑	↔
Traffic Volume (veh/h)	0	634	283	322	748	0	0	0	0	802	8	146
Future Volume (veh/h)	0	634	283	322	748	0	0	0	0	802	8	146
Initial Q (Qb), veh	0	0	0	0	0	0				0	0	0
Ped-Bike Adj(A_pbT)	1.00		1.00	1.00		1.00				1.00		1.00
Parking Bus, Adj	1.00	1.00	1.00	1.00	1.00	1.00				1.00	1.00	1.00
Work Zone On Approach		No			No						No	
Adj Sat Flow, veh/h/ln	0	1900	1900	1900	1900	0				1900	1900	1900
Adj Flow Rate, veh/h	0	640	178	325	756	0				816	0	88
Peak Hour Factor	0.99	0.99	0.99	0.99	0.99	0.99				0.99	0.99	0.99
Percent Heavy Veh, %	0	0	0	0	0	0				0	0	0
Cap, veh/h	0	986	274	356	2133	0				1102	0	490
Arrive On Green	0.00	0.35	0.35	0.12	0.35	0.00				0.30	0.00	0.30
Sat Flow, veh/h	0	2885	775	1810	3705	0				3619	0	1610
Grp Volume(v), veh/h	0	414	404	325	756	0				816	0	88
Grp Sat Flow(s),veh/h/ln	0	1805	1760	1810	1805	0				1810	0	1610
Q Serve(g_s), s	0.0	21.2	21.2	19.5	17.0	0.0				22.3	0.0	4.4
Cycle Q Clear(g_c), s	0.0	21.2	21.2	19.5	17.0	0.0				22.3	0.0	4.4
Prop In Lane	0.00		0.44	1.00		0.00				1.00		1.00
Lane Grp Cap(c), veh/h	0	638	622	356	2133	0				1102	0	490
V/C Ratio(X)	0.00	0.65	0.65	0.91	0.35	0.00				0.74	0.00	0.18
Avail Cap(c_a), veh/h	0	638	622	370	2133	0				1102	0	490
HCM Platoon Ratio	1.00	1.00	1.00	0.60	0.60	1.00				1.00	1.00	1.00
Upstream Filter(I)	0.00	0.41	0.41	0.90	0.90	0.00				1.00	0.00	1.00
Uniform Delay (d), s/veh	0.0	29.8	29.9	47.6	20.0	0.0				34.3	0.0	28.1
Incr Delay (d2), s/veh	0.0	2.1	2.2	24.0	0.4	0.0				4.5	0.0	0.8
Initial Q Delay(d3),s/veh	0.0	0.0	0.0	0.0	0.0	0.0				0.0	0.0	0.0
%ile BackOfQ(50%),veh/ln	0.0	9.0	8.8	11.4	7.7	0.0				10.0	0.0	1.8
Unsig. Movement Delay, s/veh												
LnGrp Delay(d),s/veh	0.0	32.0	32.0	71.6	20.4	0.0				38.8	0.0	28.9
LnGrp LOS	A	C	C	E	C	A				D	A	C
Approach Vol, veh/h		818			1081						904	
Approach Delay, s/veh		32.0			35.8						37.9	
Approach LOS		C			D						D	
Timer - Assigned Phs	1	2		4		6						
Phs Duration (G+Y+Rc), s	26.1	44.9		39.0		71.0						
Change Period (Y+Rc), s	4.5	6.0		5.5		6.0						
Max Green Setting (Gmax), s	22.5	38.0		33.5		65.0						
Max Q Clear Time (g_c+I1), s	21.5	23.2		24.3		19.0						
Green Ext Time (p_c), s	0.1	2.5		2.5		3.1						

Intersection Summary

HCM 6th Ctrl Delay	35.4
HCM 6th LOS	D

Notes

User approved volume balancing among the lanes for turning movement.

Timings  
5: I-215 NB Ramps & Ramona Exwy.



Lane Group	EBL	EBT	WBT	WBR	NBL	NBT	NBR
Lane Configurations	↶	↷	↶	↷	↶	↷	↷
Traffic Volume (vph)	96	1343	774	519	298	4	367
Future Volume (vph)	96	1343	774	519	298	4	367
Turn Type	Prot	NA	NA	Perm	Split	NA	Perm
Protected Phases	5	2	6		8	8	
Permitted Phases				6			8
Detector Phase	5	2	6	6	8	8	8
Switch Phase							
Minimum Initial (s)	5.0	5.0	5.0	5.0	5.0	5.0	5.0
Minimum Split (s)	9.5	11.0	26.0	26.0	10.5	10.5	10.5
Total Split (s)	23.0	68.0	45.0	45.0	42.0	42.0	42.0
Total Split (%)	20.9%	61.8%	40.9%	40.9%	38.2%	38.2%	38.2%
Yellow Time (s)	3.5	5.0	5.0	5.0	4.5	4.5	4.5
All-Red Time (s)	1.0	1.0	1.0	1.0	1.0	1.0	1.0
Lost Time Adjust (s)	0.0	0.0	0.0	0.0	0.0	0.0	0.0
Total Lost Time (s)	4.5	6.0	6.0	6.0	5.5	5.5	5.5
Lead/Lag	Lead		Lag	Lag			
Lead-Lag Optimize?	Yes		Yes	Yes			
Recall Mode	None	C-Max	C-Max	C-Max	None	None	None
Act Effct Green (s)	11.5	70.3	54.3	54.3	28.2	28.2	28.2
Actuated g/C Ratio	0.10	0.64	0.49	0.49	0.26	0.26	0.26
v/c Ratio	0.54	0.62	0.46	0.52	0.37	0.36	0.83
Control Delay	41.3	19.3	21.3	3.9	34.5	34.3	46.1
Queue Delay	0.0	48.1	0.0	0.0	0.0	0.0	0.0
Total Delay	41.3	67.5	21.3	3.9	34.5	34.3	46.1
LOS	D	E	C	A	C	C	D
Approach Delay		65.7	14.3			40.8	
Approach LOS		E	B			D	

Intersection Summary

Cycle Length: 110  
 Actuated Cycle Length: 110  
 Offset: 0 (0%), Referenced to phase 2:EBT and 6:WBT, Start of Yellow, Master Intersection  
 Natural Cycle: 55  
 Control Type: Actuated-Coordinated  
 Maximum v/c Ratio: 0.83  
 Intersection Signal Delay: 41.3  
 Intersection LOS: D  
 Intersection Capacity Utilization 113.7%  
 ICU Level of Service H  
 Analysis Period (min) 15



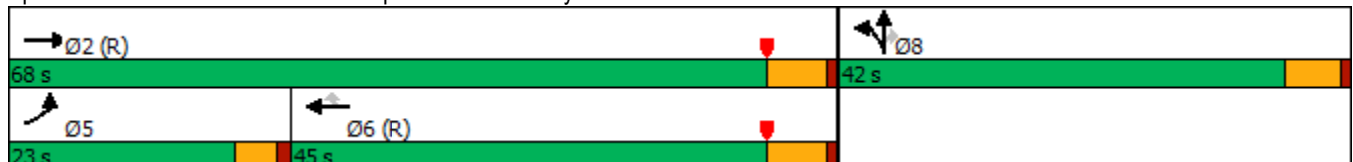















Splits and Phases: 5: I-215 NB Ramps & Ramona Exwy.



HCM 6th Signalized Intersection Summary  
 5: I-215 NB Ramps & Ramona Exwy.

MFBC Building 17 (JN 13697)

09/23/2022

												
Movement	EBL	EBT	EBR	WBL	WBT	WBR	NBL	NBT	NBR	SBL	SBT	SBR
Lane Configurations												
Traffic Volume (veh/h)	96	1343	0	0	774	519	298	4	367	0	0	0
Future Volume (veh/h)	96	1343	0	0	774	519	298	4	367	0	0	0
Initial Q (Qb), veh	0	0	0	0	0	0	0	0	0			
Ped-Bike Adj(A_pbT)	1.00		1.00	1.00		1.00	1.00		1.00			
Parking Bus, Adj	1.00	1.00	1.00	1.00	1.00	1.00	1.00	1.00	1.00			
Work Zone On Approach		No			No			No				
Adj Sat Flow, veh/h/ln	1900	1900	0	0	1900	1900	1900	1900	1900			
Adj Flow Rate, veh/h	102	1429	0	0	823	402	320	0	309			
Peak Hour Factor	0.94	0.94	0.94	0.94	0.94	0.94	0.94	0.94	0.94			
Percent Heavy Veh, %	0	0	0	0	0	0	0	0	0			
Cap, veh/h	128	2437	0	0	2033	906	798	0	355			
Arrive On Green	0.14	1.00	0.00	0.00	0.56	0.56	0.22	0.00	0.22			
Sat Flow, veh/h	1810	3705	0	0	3705	1608	3619	0	1610			
Grp Volume(v), veh/h	102	1429	0	0	823	402	320	0	309			
Grp Sat Flow(s),veh/h/ln	1810	1805	0	0	1805	1608	1810	0	1610			
Q Serve(g_s), s	6.0	0.0	0.0	0.0	14.2	16.0	8.3	0.0	20.4			
Cycle Q Clear(g_c), s	6.0	0.0	0.0	0.0	14.2	16.0	8.3	0.0	20.4			
Prop In Lane	1.00		0.00	0.00		1.00	1.00		1.00			
Lane Grp Cap(c), veh/h	128	2437	0	0	2033	906	798	0	355			
V/C Ratio(X)	0.80	0.59	0.00	0.00	0.40	0.44	0.40	0.00	0.87			
Avail Cap(c_a), veh/h	304	2437	0	0	2033	906	1201	0	534			
HCM Platoon Ratio	2.00	2.00	1.00	1.00	1.00	1.00	1.00	1.00	1.00			
Upstream Filter(I)	0.58	0.58	0.00	0.00	1.00	1.00	1.00	0.00	1.00			
Uniform Delay (d), s/veh	46.5	0.0	0.0	0.0	13.6	14.0	36.7	0.0	41.4			
Incr Delay (d2), s/veh	6.5	0.6	0.0	0.0	0.6	1.6	0.3	0.0	9.9			
Initial Q Delay(d3),s/veh	0.0	0.0	0.0	0.0	0.0	0.0	0.0	0.0	0.0			
%ile BackOfQ(50%),veh/ln	2.7	0.2	0.0	0.0	5.3	5.5	3.6	0.0	8.7			
Unsig. Movement Delay, s/veh												
LnGrp Delay(d),s/veh	52.9	0.6	0.0	0.0	14.2	15.6	37.0	0.0	51.2			
LnGrp LOS	D	A	A	A	B	B	D	A	D			
Approach Vol, veh/h		1531			1225			629				
Approach Delay, s/veh		4.1			14.6			44.0				
Approach LOS		A			B			D				
Timer - Assigned Phs		2			5	6		8				
Phs Duration (G+Y+Rc), s		80.2			12.3	68.0		29.8				
Change Period (Y+Rc), s		6.0			4.5	6.0		5.5				
Max Green Setting (Gmax), s		62.0			18.5	39.0		36.5				
Max Q Clear Time (g_c+1), s		2.0			8.0	18.0		22.4				
Green Ext Time (p_c), s		7.7			0.1	3.9		1.9				

Intersection Summary

HCM 6th Ctrl Delay	15.3
HCM 6th LOS	B

Notes

User approved volume balancing among the lanes for turning movement.



## **APPENDIX 5.2: EAP (2025) CONDITIONS TRAFFIC SIGNAL WARRANT ANALYSIS WORKSHEETS**

This Page Intentionally Left Blank

### Figure 4C-103 (CA). Traffic Signal Warrants Worksheet (Average Traffic Estimate Form)

<u>DIST</u>	<u>CO</u>	<u>RTE</u>	<u>PM</u>	<u>CALC</u>	<u>TRAFFIC CONDITIONS</u>	<u>EAP (2025)</u>
Jurisdiction: <u>County of Riverside</u>				<u>CS</u>		<u>DATE 09/23/22</u>
Major Street: <u>Harvill Av.</u>				<u>CS</u>		<u>DATE 09/23/22</u>
Minor Street: <u>Driveway 1</u>					Critical Approach Speed (Major) <u>25</u> mph	
					Critical Approach Speed (Minor) <u>25</u> mph	
Major Street Approach Lanes =		<u>2</u>	lane		Minor Street Approach Lanes =	<u>1</u> lane
Major Street Future ADT =		<u>9,124</u>	vpd		Minor Street Future ADT =	<u>64</u> vpd
Speed limit or critical speed on major street traffic > 64 km/h (40 mph); .....					<input type="checkbox"/>	
					or	<b>URBAN (U)</b>
In built up area of isolated community of < 10,000 population .....					<input type="checkbox"/>	

**(Based on Estimated Average Daily Traffic - See Note)**

<u>URBAN</u>	<u>RURAL</u>	Minimum Requirements			
<b>XX</b>		<b>EADT</b>			
<b>CONDITION A - Minimum Vehicular Volume</b>		Vehicles Per Day on Major Street		Vehicles Per Day on Higher-Volume Minor Street Approach	
<u>Satisfied</u>		(Total of Both Approaches)		(One Direction Only)	
		<u>Urban</u>	<u>Rural</u>	<u>Urban</u>	<u>Rural</u>
Number of lanes for moving traffic on each approach	Number of lanes for moving traffic on each approach				
<u>Major Street</u>	<u>Minor Street</u>				
<u>1</u>	<u>1</u>	8,000	5,600	2,400	1,680
<u>2 + 9,124</u>	<u>1 64</u>	9,600	6,720	2,400	1,680
<u>2 +</u>	<u>2 +</u>	9,600	6,720	3,200	2,240
<u>1</u>	<u>2 +</u>	8,000	5,600	3,200	2,240
<b>CONDITION B - Interruption of Continuous Traffic</b>		Vehicles Per Day on Major Street		Vehicles Per Day on Higher-Volume Minor Street Approach	
<u>Satisfied</u>		(Total of Both Approaches)		(One Direction Only)	
		<u>Urban</u>	<u>Rural</u>	<u>Urban</u>	<u>Rural</u>
Number of lanes for moving traffic on each approach	Number of lanes for moving traffic on each approach				
<u>Major Street</u>	<u>Minor Street</u>				
<u>1</u>	<u>1</u>	12,000	8,400	1,200	850
<u>2 + 9,124</u>	<u>1 64</u>	14,400	10,080	1,200	850
<u>2 +</u>	<u>2 +</u>	14,400	10,080	1,600	1,120
<u>1</u>	<u>2 +</u>	12,000	8,400	1,600	1,120
<b>Combination of CONDITIONS A + B</b>		2 CONDITIONS		2 CONDITIONS	
<u>Satisfied</u>		80%		80%	
<u>Not Satisfied</u>					
<b>XX</b>					
No one condition satisfied, but following conditions fulfilled 80% of more .....					
	<u>A</u>				
	<b>3%</b>				
	<u>B</u>				
	<b>5%</b>				

**Note: To be used only for NEW INTERSECTIONS or other locations where it is not reasonable to count actual traffic volumes.**

The satisfaction of a traffic signal warrant or warrants shall not in itself require the installation of a traffic control signal.



### Figure 4C-4. Warrant 3, Peak Hour (70% Factor)

(COMMUNITY LESS THAN 10,000 POPULATION OR ABOVE 64 km/h OR ABOVE 40 mph ON MAJOR STREET)

Traffic Conditions = **EAP (2025) Conditions - Weekday PM Peak Hour**

Major Street Name = **Harvill Avenue**

Total of Both Approaches (VPH) = **776**  
 Number of Approach Lanes Major Street = **2**

Minor Street Name = **America's Tire**

High Volume Approach (VPH) = **21**  
 Number of Approach Lanes Minor Street = **1**

**SIGNAL WARRANT NOT SATISFIED**

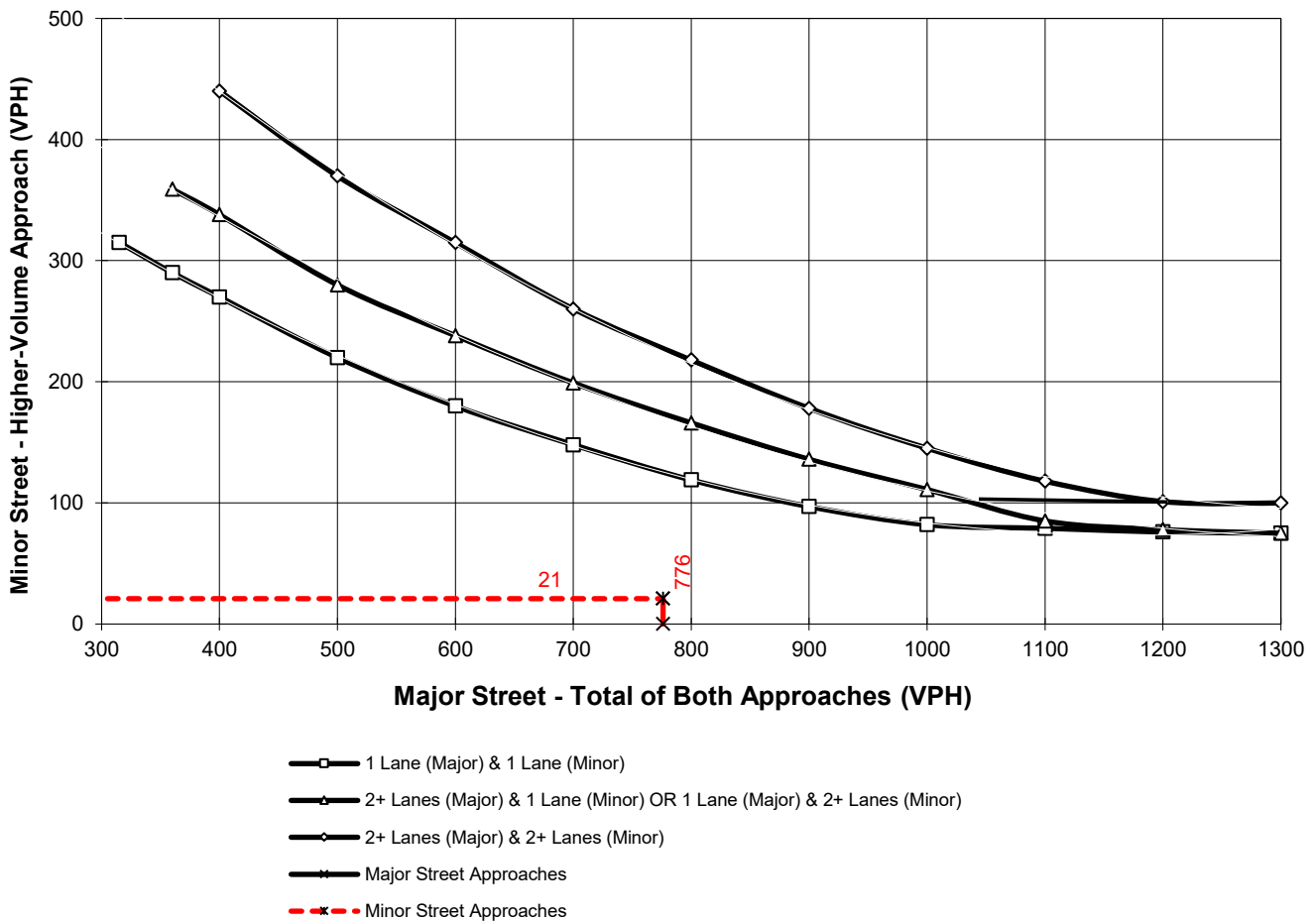

\*Note: 100 vph applies as the lower threshold for a minor-street approach with two or more lanes and 75 vph applies as the lower threshold for a minor-street approach with one lane

**APPENDIX 5.3: EAP (2025) CONDITIONS FREEWAY OFF-RAMP  
QUEUING ANALYSIS WORKSHEETS**

This Page Intentionally Left Blank

Queues

4: I-215 SB Ramps & Ramona Exwy.

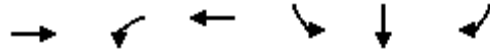

Lane Group	EBT	WBL	WBT	SBL	SBT	SBR
Lane Group Flow (vph)	720	286	978	430	432	170
v/c Ratio	0.54	0.84	0.46	0.82	0.83	0.29
Control Delay	22.6	40.2	5.6	50.2	50.4	10.9
Queue Delay	0.0	0.0	0.5	53.1	53.0	0.0
Total Delay	22.6	40.2	6.1	103.3	103.4	10.9
Queue Length 50th (ft)	161	100	101	295	296	24
Queue Length 95th (ft)	222	#289	20	#468	#469	76
Internal Link Dist (ft)	1408		344		1111	
Turn Bay Length (ft)		100		510		510
Base Capacity (vph)	1332	369	2133	522	523	577
Starvation Cap Reductn	0	0	665	0	0	0
Spillback Cap Reductn	16	0	0	157	157	0
Storage Cap Reductn	0	0	0	0	0	0
Reduced v/c Ratio	0.55	0.78	0.67	1.18	1.18	0.29

Intersection Summary

# 95th percentile volume exceeds capacity, queue may be longer.  
 Queue shown is maximum after two cycles.

Queues

5: I-215 NB Ramps & Ramona Exwy.



Lane Group	EBL	EBT	WBT	WBR	NBL	NBT	NBR
Lane Group Flow (vph)	130	1171	945	607	169	167	502
v/c Ratio	0.60	0.55	0.61	0.60	0.32	0.32	0.92
Control Delay	50.7	14.1	27.9	6.2	30.4	30.3	54.5
Queue Delay	0.0	24.6	0.0	0.0	0.0	0.0	0.0
Total Delay	50.7	38.7	27.9	6.2	30.4	30.3	54.5
Queue Length 50th (ft)	91	444	279	21	92	91	287
Queue Length 95th (ft)	142	521	378	124	152	151	#478
Internal Link Dist (ft)		344	532			1162	
Turn Bay Length (ft)	105			200			500
Base Capacity (vph)	303	2126	1546	1010	569	570	585
Starvation Cap Reductn	0	995	0	0	0	0	0
Spillback Cap Reductn	0	0	0	0	0	0	0
Storage Cap Reductn	0	0	0	0	0	0	0
Reduced v/c Ratio	0.43	1.04	0.61	0.60	0.30	0.29	0.86

Intersection Summary

# 95th percentile volume exceeds capacity, queue may be longer.  
 Queue shown is maximum after two cycles.



Queues

4: I-215 SB Ramps & Ramona Exwy.

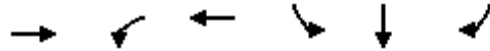

Lane Group	EBT	WBL	WBT	SBL	SBT	SBR
Lane Group Flow (vph)	926	325	756	405	413	147
v/c Ratio	0.74	0.91	0.35	0.78	0.79	0.25
Control Delay	33.0	51.8	6.7	46.5	47.5	5.8
Queue Delay	0.0	0.0	0.3	55.8	55.6	0.0
Total Delay	33.1	51.8	7.0	102.4	103.0	5.8
Queue Length 50th (ft)	280	224	137	273	280	0
Queue Length 95th (ft)	358	#354	22	#424	#437	46
Internal Link Dist (ft)	1408		344		1111	
Turn Bay Length (ft)		100		510		510
Base Capacity (vph)	1258	369	2133	522	523	594
Starvation Cap Reductn	0	0	693	0	0	0
Spillback Cap Reductn	8	0	0	207	208	0
Storage Cap Reductn	0	0	0	0	0	0
Reduced v/c Ratio	0.74	0.88	0.53	1.29	1.31	0.25

Intersection Summary

# 95th percentile volume exceeds capacity, queue may be longer.  
 Queue shown is maximum after two cycles.

Queues

5: I-215 NB Ramps & Ramona Exwy.



Lane Group	EBL	EBT	WBT	WBR	NBL	NBT	NBR
Lane Group Flow (vph)	102	1429	823	552	162	159	390
v/c Ratio	0.54	0.62	0.46	0.52	0.37	0.36	0.83
Control Delay	41.3	19.3	21.3	3.9	34.5	34.3	46.1
Queue Delay	0.0	48.1	0.0	0.0	0.0	0.0	0.0
Total Delay	41.3	67.5	21.3	3.9	34.5	34.3	46.1
Queue Length 50th (ft)	69	516	195	0	98	96	214
Queue Length 95th (ft)	m87	578	308	70	147	144	302
Internal Link Dist (ft)		344	532			1162	
Turn Bay Length (ft)	105			200			500
Base Capacity (vph)	303	2308	1783	1063	569	571	585
Starvation Cap Reductn	0	1007	0	0	0	0	0
Spillback Cap Reductn	0	0	0	0	0	0	0
Storage Cap Reductn	0	0	0	0	0	0	0
Reduced v/c Ratio	0.34	1.10	0.46	0.52	0.28	0.28	0.67

Intersection Summary

m Volume for 95th percentile queue is metered by upstream signal.

## **APPENDIX 6.1: EAPC (2025) CONDITIONS INTERSECTION OPERATIONS ANALYSIS WORKSHEETS**

This Page Intentionally Left Blank

Intersection						
Int Delay, s/veh	0					
Movement	WBL	WBR	NBT	NBR	SBL	SBT
Lane Configurations	↘↗		↑↑		↘	↑↑
Traffic Vol, veh/h	0	1	1579	1	4	955
Future Vol, veh/h	0	1	1579	1	4	955
Conflicting Peds, #/hr	0	0	0	0	0	0
Sign Control	Stop	Stop	Free	Free	Free	Free
RT Channelized	-	None	-	None	-	None
Storage Length	0	-	-	-	100	-
Veh in Median Storage, #	1	-	0	-	-	0
Grade, %	0	-	0	-	-	0
Peak Hour Factor	92	92	92	92	92	92
Heavy Vehicles, %	0	0	0	0	0	0
Mvmt Flow	0	1	1716	1	4	1038

Major/Minor	Minor1	Major1	Major2		
Conflicting Flow All	2244	859	0	0	1717
Stage 1	1717	-	-	-	-
Stage 2	527	-	-	-	-
Critical Hdwy	6.8	6.9	-	-	4.1
Critical Hdwy Stg 1	5.8	-	-	-	-
Critical Hdwy Stg 2	5.8	-	-	-	-
Follow-up Hdwy	3.5	3.3	-	-	2.2
Pot Cap-1 Maneuver	36	304	-	-	374
Stage 1	133	-	-	-	-
Stage 2	562	-	-	-	-
Platoon blocked, %			-	-	-
Mov Cap-1 Maneuver	36	304	-	-	374
Mov Cap-2 Maneuver	107	-	-	-	-
Stage 1	133	-	-	-	-
Stage 2	556	-	-	-	-

Approach	WB	NB	SB
HCM Control Delay, s	16.9	0	0.1
HCM LOS	C		

Minor Lane/Major Mvmt	NBT	NBRWBLn1	SBL	SBT
Capacity (veh/h)	-	-	304	374
HCM Lane V/C Ratio	-	-	0.004	0.012
HCM Control Delay (s)	-	-	16.9	14.7
HCM Lane LOS	-	-	C	B
HCM 95th %tile Q(veh)	-	-	0	0

Intersection						
Int Delay, s/veh	0.1					
Movement	WBL	WBR	NBT	NBR	SBL	SBT
Lane Configurations	↵	↶	↶↷		↵	↶↷
Traffic Vol, veh/h	3	5	1265	9	10	704
Future Vol, veh/h	3	5	1265	9	10	704
Conflicting Peds, #/hr	0	0	0	0	0	0
Sign Control	Stop	Stop	Free	Free	Free	Free
RT Channelized	-	None	-	None	-	None
Storage Length	0	0	-	-	130	-
Veh in Median Storage, #	1	-	0	-	-	0
Grade, %	0	-	0	-	-	0
Peak Hour Factor	94	94	94	94	94	94
Heavy Vehicles, %	0	0	0	0	0	0
Mvmt Flow	3	5	1346	10	11	749

Major/Minor	Minor1	Major1	Major2		
Conflicting Flow All	1748	678	0	0	1356
Stage 1	1351	-	-	-	-
Stage 2	397	-	-	-	-
Critical Hdwy	6.8	6.9	-	-	4.1
Critical Hdwy Stg 1	5.8	-	-	-	-
Critical Hdwy Stg 2	5.8	-	-	-	-
Follow-up Hdwy	3.5	3.3	-	-	2.2
Pot Cap-1 Maneuver	79	399	-	-	514
Stage 1	210	-	-	-	-
Stage 2	654	-	-	-	-
Platoon blocked, %			-	-	-
Mov Cap-1 Maneuver	77	399	-	-	514
Mov Cap-2 Maneuver	168	-	-	-	-
Stage 1	210	-	-	-	-
Stage 2	640	-	-	-	-

Approach	WB	NB	SB
HCM Control Delay, s	18.9	0	0.2
HCM LOS	C		

Minor Lane/Major Mvmt	NBT	NBRWBLn1	WBLn2	SBL	SBT
Capacity (veh/h)	-	-	168	399	514
HCM Lane V/C Ratio	-	-	0.019	0.013	0.021
HCM Control Delay (s)	-	-	26.8	14.1	12.2
HCM Lane LOS	-	-	D	B	B
HCM 95th %tile Q(veh)	-	-	0.1	0	0.1

Timings  
3: Harvill Av. & Cajalco Exwy./Ramona Exwy.

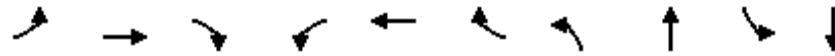

Lane Group	EBL	EBT	EBR	WBL	WBT	WBR	NBL	NBT	SBL	SBT
Lane Configurations	↙	↑↑	↗	↙↗	↑↑	↗	↙↗	↑↑	↙↗	↑↑
Traffic Volume (vph)	191	841	218	640	1130	761	373	434	427	230
Future Volume (vph)	191	841	218	640	1130	761	373	434	427	230
Turn Type	Prot	NA	Perm	Prot	NA	pm+ov	Prot	NA	Prot	NA
Protected Phases	5	2		1	6	7	3	8	7	4
Permitted Phases			2			6				
Detector Phase	5	2	2	1	6	7	3	8	7	4
Switch Phase										
Minimum Initial (s)	5.0	10.0	10.0	5.0	10.0	5.0	5.0	10.0	5.0	10.0
Minimum Split (s)	9.6	36.2	36.2	9.6	32.5	9.6	9.6	16.2	9.6	41.2
Total Split (s)	10.2	38.8	38.8	16.7	45.3	15.6	23.3	48.9	15.6	41.2
Total Split (%)	8.5%	32.3%	32.3%	13.9%	37.8%	13.0%	19.4%	40.8%	13.0%	34.3%
Yellow Time (s)	3.6	5.2	5.2	3.6	3.5	3.6	3.6	5.2	3.6	5.2
All-Red Time (s)	1.0	1.0	1.0	1.0	1.0	1.0	1.0	1.0	1.0	1.0
Lost Time Adjust (s)	0.0	0.0	0.0	0.0	0.0	0.0	0.0	0.0	0.0	0.0
Total Lost Time (s)	4.6	6.2	6.2	4.6	4.5	4.6	4.6	6.2	4.6	6.2
Lead/Lag	Lead	Lag	Lag	Lead	Lag	Lead	Lead	Lag	Lead	Lag
Lead-Lag Optimize?	Yes	Yes	Yes	Yes	Yes	Yes	Yes	Yes	Yes	Yes
Recall Mode	None	None	None	None	None	None	None	Max	None	Max
Act Effct Green (s)	5.6	32.6	32.6	12.1	40.8	56.3	16.9	42.7	11.0	36.8
Actuated g/C Ratio	0.05	0.27	0.27	0.10	0.34	0.47	0.14	0.36	0.09	0.31
v/c Ratio	2.44	0.92	0.39	1.95	0.99	0.96	0.81	0.57	1.43	0.31
Control Delay	706.8	58.0	7.3	466.5	63.1	48.6	63.6	28.8	249.8	28.9
Queue Delay	0.0	0.0	0.0	0.0	0.0	0.0	0.0	0.0	0.0	0.0
Total Delay	706.8	58.0	7.3	466.5	63.1	48.6	63.6	28.8	249.8	28.9
LOS	F	E	A	F	E	D	E	C	F	C
Approach Delay		148.2			160.7			41.2		156.5
Approach LOS		F			F			D		F

Intersection Summary

Cycle Length: 120  
 Actuated Cycle Length: 120  
 Natural Cycle: 130  
 Control Type: Actuated-Uncoordinated  
 Maximum v/c Ratio: 2.44  
 Intersection Signal Delay: 134.9  
 Intersection LOS: F  
 Intersection Capacity Utilization 91.4%  
 ICU Level of Service F  
 Analysis Period (min) 15

Splits and Phases: 3: Harvill Av. & Cajalco Exwy./Ramona Exwy.

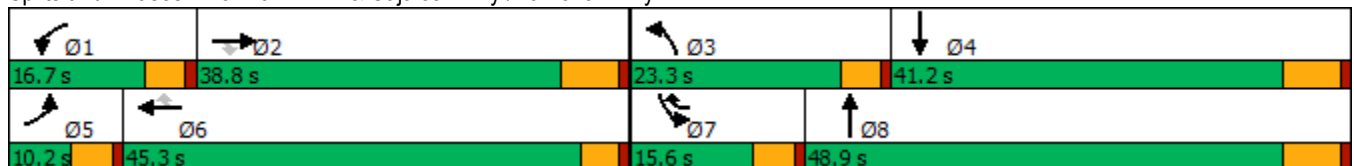

HCM 6th Signalized Intersection Summary  
 3: Harvill Av. & Cajalco Exwy./Ramona Exwy.

MFBC Building 17 (JN 13697)

09/23/2022



Movement	EBL	EBT	EBR	WBL	WBT	WBR	NBL	NBT	NBR	SBL	SBT	SBR
Lane Configurations												
Traffic Volume (veh/h)	191	841	218	640	1130	761	373	434	240	427	230	83
Future Volume (veh/h)	191	841	218	640	1130	761	373	434	240	427	230	83
Initial Q (Qb), veh	0	0	0	0	0	0	0	0	0	0	0	0
Ped-Bike Adj(A_pbT)	1.00		1.00	1.00		1.00	1.00		0.99	1.00		1.00
Parking Bus, Adj	1.00	1.00	1.00	1.00	1.00	1.00	1.00	1.00	1.00	1.00	1.00	1.00
Work Zone On Approach		No			No			No			No	
Adj Sat Flow, veh/h/ln	1900	1900	1900	1900	1900	1900	1900	1900	1900	1900	1900	1900
Adj Flow Rate, veh/h	205	904	183	688	1215	750	401	467	204	459	247	87
Peak Hour Factor	0.93	0.93	0.93	0.93	0.93	0.93	0.93	0.93	0.93	0.93	0.93	0.93
Percent Heavy Veh, %	0	0	0	0	0	0	0	0	0	0	0	0
Cap, veh/h	83	1017	454	349	1210	685	459	856	371	317	819	281
Arrive On Green	0.05	0.28	0.28	0.10	0.34	0.34	0.13	0.35	0.35	0.09	0.31	0.31
Sat Flow, veh/h	1810	3610	1610	3510	3610	1610	3510	2441	1058	3510	2637	905
Grp Volume(v), veh/h	205	904	183	688	1215	750	401	344	327	459	167	167
Grp Sat Flow(s),veh/h/ln	1810	1805	1610	1755	1805	1610	1755	1805	1694	1755	1805	1737
Q Serve(g_s), s	5.6	29.2	11.2	12.1	40.8	40.8	13.6	18.6	18.9	11.0	8.6	8.9
Cycle Q Clear(g_c), s	5.6	29.2	11.2	12.1	40.8	40.8	13.6	18.6	18.9	11.0	8.6	8.9
Prop In Lane	1.00		1.00	1.00		1.00	1.00		0.62	1.00		0.52
Lane Grp Cap(c), veh/h	83	1017	454	349	1210	685	459	633	594	317	561	539
V/C Ratio(X)	2.46	0.89	0.40	1.97	1.00	1.09	0.87	0.54	0.55	1.45	0.30	0.31
Avail Cap(c_a), veh/h	83	1017	454	349	1210	685	539	633	594	317	561	539
HCM Platoon Ratio	1.00	1.00	1.00	1.00	1.00	1.00	1.00	1.00	1.00	1.00	1.00	1.00
Upstream Filter(I)	1.00	1.00	1.00	1.00	1.00	1.00	1.00	1.00	1.00	1.00	1.00	1.00
Uniform Delay (d), s/veh	58.0	41.9	35.4	54.8	40.5	34.9	51.9	31.7	31.8	55.3	31.9	32.0
Incr Delay (d2), s/veh	692.5	9.7	0.6	447.3	26.8	63.0	11.9	3.3	3.6	217.9	1.4	1.5
Initial Q Delay(d3),s/veh	0.0	0.0	0.0	0.0	0.0	0.0	0.0	0.0	0.0	0.0	0.0	0.0
%ile BackOfQ(50%),veh/ln	18.5	13.7	4.3	26.8	21.5	30.6	6.5	8.3	7.9	14.3	3.8	3.8
Unsig. Movement Delay, s/veh												
LnGrp Delay(d),s/veh	750.5	51.6	36.0	502.1	67.3	97.9	63.8	35.0	35.4	273.3	33.2	33.5
LnGrp LOS	F	D	D	F	F	F	E	D	D	F	C	C
Approach Vol, veh/h		1292			2653			1072			793	
Approach Delay, s/veh		160.3			188.7			45.9			172.2	
Approach LOS		F			F			D			F	
Timer - Assigned Phs	1	2	3	4	5	6	7	8				
Phs Duration (G+Y+Rc), s	16.7	40.5	20.5	44.0	10.2	47.0	15.6	48.9				
Change Period (Y+Rc), s	4.6	6.2	4.6	6.2	4.6	* 6.2	4.6	6.2				
Max Green Setting (Gmax), s	12.1	32.6	18.7	35.0	5.6	* 41	11.0	42.7				
Max Q Clear Time (g_c+I1), s	14.1	31.2	15.6	10.9	7.6	42.8	13.0	20.9				
Green Ext Time (p_c), s	0.0	0.9	0.3	1.7	0.0	0.0	0.0	3.7				

Intersection Summary

HCM 6th Ctrl Delay	153.8
HCM 6th LOS	F

Notes

\* HCM 6th computational engine requires equal clearance times for the phases crossing the barrier.



Timings  
4: I-215 SB Ramps & Ramona Exwy.

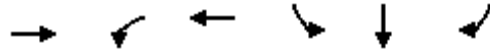

Lane Group	EBT	WBL	WBT	SBL	SBT	SBR
Lane Configurations	↑↑	↖	↑↑	↖	↖	↖
Traffic Volume (vph)	785	547	1877	1847	2	780
Future Volume (vph)	785	547	1877	1847	2	780
Turn Type	NA	Prot	NA	Split	NA	Perm
Protected Phases	2	1	6	4	4	
Permitted Phases						4
Detector Phase	2	1	6	4	4	4
Switch Phase						
Minimum Initial (s)	5.0	5.0	5.0	5.0	5.0	5.0
Minimum Split (s)	11.0	9.5	31.0	10.5	10.5	10.5
Total Split (s)	44.0	27.0	71.0	39.0	39.0	39.0
Total Split (%)	40.0%	24.5%	64.5%	35.5%	35.5%	35.5%
Yellow Time (s)	5.0	3.5	5.0	4.5	4.5	4.5
All-Red Time (s)	1.0	1.0	1.0	1.0	1.0	1.0
Lost Time Adjust (s)	0.0	0.0	0.0	0.0	0.0	0.0
Total Lost Time (s)	6.0	4.5	6.0	5.5	5.5	5.5
Lead/Lag	Lag	Lead				
Lead-Lag Optimize?	Yes	Yes				
Recall Mode	C-Max	None	C-Max	Max	Max	Max
Act Effct Green (s)	38.0	22.5	65.0	33.5	33.5	33.5
Actuated g/C Ratio	0.35	0.20	0.59	0.30	0.30	0.30
v/c Ratio	1.02	1.51	0.90	1.80	1.81	1.47
Control Delay	64.4	260.2	10.2	396.2	397.2	248.0
Queue Delay	6.9	0.0	46.1	12.5	12.5	0.0
Total Delay	71.2	260.2	56.3	408.7	409.7	248.0
LOS	E	F	E	F	F	F
Approach Delay	71.2		102.3		361.4	
Approach LOS	E		F		F	

Intersection Summary

Cycle Length: 110  
 Actuated Cycle Length: 110  
 Offset: 34 (31%), Referenced to phase 2:EBT and 6:WBT, Start of Yellow  
 Natural Cycle: 150  
 Control Type: Actuated-Coordinated  
 Maximum v/c Ratio: 1.81  
 Intersection Signal Delay: 204.1  
 Intersection LOS: F  
 Intersection Capacity Utilization 238.7%  
 ICU Level of Service H  
 Analysis Period (min) 15

Splits and Phases: 4: I-215 SB Ramps & Ramona Exwy.



HCM 6th Signalized Intersection Summary  
 4: I-215 SB Ramps & Ramona Exwy.

MFBC Building 17 (JN 13697)

09/23/2022



Movement	EBL	EBT	EBR	WBL	WBT	WBR	NBL	NBT	NBR	SBL	SBT	SBR
Lane Configurations		↑↑		↑	↑↑					↑	↑	↑
Traffic Volume (veh/h)	0	785	472	547	1877	0	0	0	0	1847	2	780
Future Volume (veh/h)	0	785	472	547	1877	0	0	0	0	1847	2	780
Initial Q (Qb), veh	0	0	0	0	0	0				0	0	0
Ped-Bike Adj(A_pbT)	1.00		0.99	1.00		1.00				1.00		1.00
Parking Bus, Adj	1.00	1.00	1.00	1.00	1.00	1.00				1.00	1.00	1.00
Work Zone On Approach		No			No						No	
Adj Sat Flow, veh/h/ln	0	1900	1900	1900	1900	0				1900	1900	1900
Adj Flow Rate, veh/h	0	801	353	558	1915	0				1886	0	733
Peak Hour Factor	0.98	0.98	0.98	0.98	0.98	0.98				0.98	0.98	0.98
Percent Heavy Veh, %	0	0	0	0	0	0				0	0	0
Cap, veh/h	0	839	369	370	2133	0				1102	0	490
Arrive On Green	0.00	0.35	0.35	0.12	0.35	0.00				0.30	0.00	0.30
Sat Flow, veh/h	0	2524	1068	1810	3705	0				3619	0	1610
Grp Volume(v), veh/h	0	595	559	558	1915	0				1886	0	733
Grp Sat Flow(s),veh/h/ln	0	1805	1692	1810	1805	0				1810	0	1610
Q Serve(g_s), s	0.0	35.4	35.6	22.5	55.2	0.0				33.5	0.0	33.5
Cycle Q Clear(g_c), s	0.0	35.4	35.6	22.5	55.2	0.0				33.5	0.0	33.5
Prop In Lane	0.00		0.63	1.00		0.00				1.00		1.00
Lane Grp Cap(c), veh/h	0	624	584	370	2133	0				1102	0	490
V/C Ratio(X)	0.00	0.95	0.96	1.51	0.90	0.00				1.71	0.00	1.49
Avail Cap(c_a), veh/h	0	624	584	370	2133	0				1102	0	490
HCM Platoon Ratio	1.00	1.00	1.00	0.60	0.60	1.00				1.00	1.00	1.00
Upstream Filter(I)	0.00	0.09	0.09	0.09	0.09	0.00				1.00	0.00	1.00
Uniform Delay (d), s/veh	0.0	35.1	35.2	48.2	32.4	0.0				38.3	0.0	38.3
Incr Delay (d2), s/veh	0.0	4.4	4.9	229.7	0.7	0.0				323.9	0.0	233.2
Initial Q Delay(d3),s/veh	0.0	0.0	0.0	0.0	0.0	0.0				0.0	0.0	0.0
%ile BackOfQ(50%),veh/ln	0.0	15.1	14.4	34.0	24.7	0.0				63.6	0.0	44.2
Unsig. Movement Delay, s/veh												
LnGrp Delay(d),s/veh	0.0	39.5	40.1	278.0	33.0	0.0				362.2	0.0	271.5
LnGrp LOS	A	D	D	F	C	A				F	A	F
Approach Vol, veh/h		1154			2473						2619	
Approach Delay, s/veh		39.8			88.3						336.8	
Approach LOS		D			F						F	
Timer - Assigned Phs	1	2		4		6						
Phs Duration (G+Y+Rc), s	27.0	44.0		39.0		71.0						
Change Period (Y+Rc), s	4.5	6.0		5.5		6.0						
Max Green Setting (Gmax), s	22.5	38.0		33.5		65.0						
Max Q Clear Time (g_c+I1), s	24.5	37.6		35.5		57.2						
Green Ext Time (p_c), s	0.0	0.2		0.0		5.2						

Intersection Summary

HCM 6th Ctrl Delay	183.5
HCM 6th LOS	F

Notes

User approved volume balancing among the lanes for turning movement.

Timings  
5: I-215 NB Ramps & Ramona Exwy.



Lane Group	EBL	EBT	WBT	WBR	NBL	NBT	NBR
Lane Configurations	↶	↷↷	↷↷	↷	↶	↷	↷
Traffic Volume (vph)	320	2316	1520	1471	906	4	808
Future Volume (vph)	320	2316	1520	1471	906	4	808
Turn Type	Prot	NA	NA	Perm	Split	NA	Perm
Protected Phases	5	2	6		8	8	
Permitted Phases				6			8
Detector Phase	5	2	6	6	8	8	8
Switch Phase							
Minimum Initial (s)	5.0	5.0	5.0	5.0	5.0	5.0	5.0
Minimum Split (s)	9.5	11.0	26.0	26.0	10.5	10.5	10.5
Total Split (s)	23.0	68.0	45.0	45.0	42.0	42.0	42.0
Total Split (%)	20.9%	61.8%	40.9%	40.9%	38.2%	38.2%	38.2%
Yellow Time (s)	3.5	5.0	5.0	5.0	4.5	4.5	4.5
All-Red Time (s)	1.0	1.0	1.0	1.0	1.0	1.0	1.0
Lost Time Adjust (s)	0.0	0.0	0.0	0.0	0.0	0.0	0.0
Total Lost Time (s)	4.5	6.0	6.0	6.0	5.5	5.5	5.5
Lead/Lag	Lead		Lag	Lag			
Lead-Lag Optimize?	Yes		Yes	Yes			
Recall Mode	None	C-Max	C-Max	C-Max	None	None	None
Act Effct Green (s)	18.5	62.0	39.0	39.0	36.5	36.5	36.5
Actuated g/C Ratio	0.17	0.56	0.35	0.35	0.33	0.33	0.33
v/c Ratio	1.09	1.17	1.23	1.44	0.82	0.83	1.42
Control Delay	95.0	104.0	141.1	222.9	47.3	47.7	229.0
Queue Delay	0.0	2.4	0.9	0.0	0.0	0.0	0.0
Total Delay	95.0	106.4	142.0	222.9	47.3	47.7	229.0
LOS	F	F	F	F	D	D	F
Approach Delay		105.0	181.8			132.8	
Approach LOS		F	F			F	

Intersection Summary

Cycle Length: 110  
 Actuated Cycle Length: 110  
 Offset: 0 (0%), Referenced to phase 2:EBT and 6:WBT, Start of Yellow, Master Intersection  
 Natural Cycle: 130  
 Control Type: Actuated-Coordinated  
 Maximum v/c Ratio: 1.44  
 Intersection Signal Delay: 142.8  
 Intersection LOS: F  
 Intersection Capacity Utilization 238.7%  
 ICU Level of Service H  
 Analysis Period (min) 15

Splits and Phases: 5: I-215 NB Ramps & Ramona Exwy.

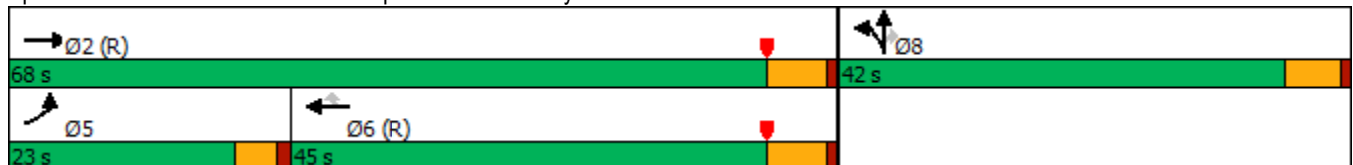

HCM 6th Signalized Intersection Summary  
 5: I-215 NB Ramps & Ramona Exwy.

MFBC Building 17 (JN 13697)  
 09/23/2022



Movement	EBL	EBT	EBR	WBL	WBT	WBR	NBL	NBT	NBR	SBL	SBT	SBR
Lane Configurations	↘	↑↑			↑↑	↗	↘	↗	↗			
Traffic Volume (veh/h)	320	2316	0	0	1520	1471	906	4	808	0	0	0
Future Volume (veh/h)	320	2316	0	0	1520	1471	906	4	808	0	0	0
Initial Q (Qb), veh	0	0	0	0	0	0	0	0	0			
Ped-Bike Adj(A_pbT)	1.00		1.00	1.00		1.00	1.00		1.00			
Parking Bus, Adj	1.00	1.00	1.00	1.00	1.00	1.00	1.00	1.00	1.00			
Work Zone On Approach		No			No			No				
Adj Sat Flow, veh/h/ln	1900	1900	0	0	1900	1900	1900	1900	1900			
Adj Flow Rate, veh/h	330	2388	0	0	1567	1368	937	0	681			
Peak Hour Factor	0.97	0.97	0.97	0.97	0.97	0.97	0.97	0.97	0.97			
Percent Heavy Veh, %	0	0	0	0	0	0	0	0	0			
Cap, veh/h	304	2035	0	0	1280	571	1201	0	534			
Arrive On Green	0.22	0.75	0.00	0.00	0.35	0.35	0.33	0.00	0.33			
Sat Flow, veh/h	1810	3705	0	0	3705	1610	3619	0	1610			
Grp Volume(v), veh/h	330	2388	0	0	1567	1368	937	0	681			
Grp Sat Flow(s),veh/h/ln	1810	1805	0	0	1805	1610	1810	0	1610			
Q Serve(g_s), s	18.5	62.0	0.0	0.0	39.0	39.0	25.7	0.0	36.5			
Cycle Q Clear(g_c), s	18.5	62.0	0.0	0.0	39.0	39.0	25.7	0.0	36.5			
Prop In Lane	1.00		0.00	0.00		1.00	1.00		1.00			
Lane Grp Cap(c), veh/h	304	2035	0	0	1280	571	1201	0	534			
V/C Ratio(X)	1.08	1.17	0.00	0.00	1.22	2.40	0.78	0.00	1.27			
Avail Cap(c_a), veh/h	304	2035	0	0	1280	571	1201	0	534			
HCM Platoon Ratio	1.33	1.33	1.00	1.00	1.00	1.00	1.00	1.00	1.00			
Upstream Filter(I)	0.09	0.09	0.00	0.00	1.00	1.00	1.00	0.00	1.00			
Uniform Delay (d), s/veh	42.7	13.8	0.0	0.0	35.5	35.5	33.1	0.0	36.8			
Incr Delay (d2), s/veh	43.9	78.7	0.0	0.0	108.1	633.7	3.4	0.0	137.6			
Initial Q Delay(d3),s/veh	0.0	0.0	0.0	0.0	0.0	0.0	0.0	0.0	0.0			
%ile BackOfQ(50%),veh/ln	11.0	32.9	0.0	0.0	35.0	114.6	11.2	0.0	33.9			
Unsig. Movement Delay, s/veh												
LnGrp Delay(d),s/veh	86.6	92.4	0.0	0.0	143.6	669.2	36.5	0.0	174.4			
LnGrp LOS	F	F	A	A	F	F	D	A	F			
Approach Vol, veh/h		2718			2935			1618				
Approach Delay, s/veh		91.7			388.6			94.5				
Approach LOS		F			F			F				
Timer - Assigned Phs		2			5	6		8				
Phs Duration (G+Y+Rc), s		68.0			23.0	45.0		42.0				
Change Period (Y+Rc), s		6.0			4.5	6.0		5.5				
Max Green Setting (Gmax), s		62.0			18.5	39.0		36.5				
Max Q Clear Time (g_c+I1), s		64.0			20.5	41.0		38.5				
Green Ext Time (p_c), s		0.0			0.0	0.0		0.0				

Intersection Summary

HCM 6th Ctrl Delay	212.2
HCM 6th LOS	F

Notes

User approved volume balancing among the lanes for turning movement.

Intersection						
Int Delay, s/veh	0					
Movement	WBL	WBR	NBT	NBR	SBL	SBT
Lane Configurations	↔		↑↓		↔	↑↑
Traffic Vol, veh/h	2	5	1106	1	2	1538
Future Vol, veh/h	2	5	1106	1	2	1538
Conflicting Peds, #/hr	0	0	0	0	0	0
Sign Control	Stop	Stop	Free	Free	Free	Free
RT Channelized	-	None	-	None	-	None
Storage Length	0	-	-	-	100	-
Veh in Median Storage, #	0	-	0	-	-	0
Grade, %	0	-	0	-	-	0
Peak Hour Factor	92	92	92	92	92	92
Heavy Vehicles, %	0	0	0	0	0	0
Mvmt Flow	2	5	1202	1	2	1672

Major/Minor	Minor1	Major1	Major2		
Conflicting Flow All	2043	602	0	0	1203
Stage 1	1203	-	-	-	-
Stage 2	840	-	-	-	-
Critical Hdwy	6.8	6.9	-	-	4.1
Critical Hdwy Stg 1	5.8	-	-	-	-
Critical Hdwy Stg 2	5.8	-	-	-	-
Follow-up Hdwy	3.5	3.3	-	-	2.2
Pot Cap-1 Maneuver	50	448	-	-	587
Stage 1	251	-	-	-	-
Stage 2	389	-	-	-	-
Platoon blocked, %			-	-	-
Mov Cap-1 Maneuver	50	448	-	-	587
Mov Cap-2 Maneuver	161	-	-	-	-
Stage 1	251	-	-	-	-
Stage 2	388	-	-	-	-

Approach	WB	NB	SB
HCM Control Delay, s	17.4	0	0
HCM LOS	C		

Minor Lane/Major Mvmt	NBT	NBRWBLn1	SBL	SBT
Capacity (veh/h)	-	-	297	587
HCM Lane V/C Ratio	-	-	0.026	0.004
HCM Control Delay (s)	-	-	17.4	11.2
HCM Lane LOS	-	-	C	B
HCM 95th %tile Q(veh)	-	-	0.1	0

Intersection						
Int Delay, s/veh	0.2					
Movement	WBL	WBR	NBT	NBR	SBL	SBT
Lane Configurations	↘	↗	↕		↘	↕
Traffic Vol, veh/h	10	11	855	5	3	1224
Future Vol, veh/h	10	11	855	5	3	1224
Conflicting Peds, #/hr	0	0	0	0	0	0
Sign Control	Stop	Stop	Free	Free	Free	Free
RT Channelized	-	None	-	None	-	None
Storage Length	0	0	-	-	130	-
Veh in Median Storage, #	1	-	0	-	-	0
Grade, %	0	-	0	-	-	0
Peak Hour Factor	90	90	90	90	90	90
Heavy Vehicles, %	0	0	0	0	0	0
Mvmt Flow	11	12	950	6	3	1360

Major/Minor	Minor1	Major1	Major2		
Conflicting Flow All	1639	478	0	0	956
Stage 1	953	-	-	-	-
Stage 2	686	-	-	-	-
Critical Hdwy	6.8	6.9	-	-	4.1
Critical Hdwy Stg 1	5.8	-	-	-	-
Critical Hdwy Stg 2	5.8	-	-	-	-
Follow-up Hdwy	3.5	3.3	-	-	2.2
Pot Cap-1 Maneuver	93	539	-	-	727
Stage 1	340	-	-	-	-
Stage 2	467	-	-	-	-
Platoon blocked, %			-	-	-
Mov Cap-1 Maneuver	93	539	-	-	727
Mov Cap-2 Maneuver	220	-	-	-	-
Stage 1	340	-	-	-	-
Stage 2	465	-	-	-	-

Approach	WB	NB	SB
HCM Control Delay, s	16.8	0	0
HCM LOS	C		

Minor Lane/Major Mvmt	NBT	NBRWBLn1	WBLn2	SBL	SBT
Capacity (veh/h)	-	-	220	539	727
HCM Lane V/C Ratio	-	-	0.051	0.023	0.005
HCM Control Delay (s)	-	-	22.2	11.8	10
HCM Lane LOS	-	-	C	B	A
HCM 95th %tile Q(veh)	-	-	0.2	0.1	0

Timings  
3: Harvill Av. & Cajalco Exwy./Ramona Exwy.

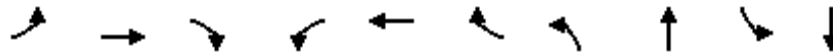

Lane Group	EBL	EBT	EBR	WBL	WBT	WBR	NBL	NBT	SBL	SBT
Lane Configurations	↙	↕	↘	↙↘	↕	↘	↙↘	↕↘	↙↘	↕↘
Traffic Volume (vph)	125	1238	297	350	929	477	312	241	920	321
Future Volume (vph)	125	1238	297	350	929	477	312	241	920	321
Turn Type	Prot	NA	Perm	Prot	NA	pm+ov	Prot	NA	Prot	NA
Protected Phases	5	2		1	6	7	3	8	7	4
Permitted Phases			2			6				
Detector Phase	5	2	2	1	6	7	3	8	7	4
Switch Phase										
Minimum Initial (s)	5.0	10.0	10.0	5.0	10.0	5.0	5.0	10.0	5.0	10.0
Minimum Split (s)	9.6	36.2	36.2	9.6	32.5	9.6	9.6	16.2	9.6	41.2
Total Split (s)	10.2	38.8	38.8	16.7	45.3	15.6	23.3	48.9	15.6	41.2
Total Split (%)	8.5%	32.3%	32.3%	13.9%	37.8%	13.0%	19.4%	40.8%	13.0%	34.3%
Yellow Time (s)	3.6	5.2	5.2	3.6	3.5	3.6	3.6	5.2	3.6	5.2
All-Red Time (s)	1.0	1.0	1.0	1.0	1.0	1.0	1.0	1.0	1.0	1.0
Lost Time Adjust (s)	0.0	0.0	0.0	0.0	0.0	0.0	0.0	0.0	0.0	0.0
Total Lost Time (s)	4.6	6.2	6.2	4.6	4.5	4.6	4.6	6.2	4.6	6.2
Lead/Lag	Lead	Lag	Lag	Lead	Lag	Lead	Lead	Lag	Lead	Lag
Lead-Lag Optimize?	Yes	Yes	Yes	Yes	Yes	Yes	Yes	Yes	Yes	Yes
Recall Mode	None	None	None	None	None	None	None	Max	None	Max
Act Effct Green (s)	5.6	32.6	32.6	12.1	40.8	56.3	15.5	42.7	11.0	38.2
Actuated g/C Ratio	0.05	0.27	0.27	0.10	0.34	0.47	0.13	0.36	0.09	0.32
v/c Ratio	1.60	1.36	0.54	1.07	0.81	0.54	0.74	0.94dr	3.08	0.47
Control Delay	353.0	203.2	16.7	117.3	42.6	7.9	60.6	30.8	963.6	29.1
Queue Delay	0.0	0.0	0.0	0.0	0.0	0.0	0.0	0.0	0.0	0.0
Total Delay	353.0	203.2	16.7	117.3	42.6	7.9	60.6	30.8	963.6	29.1
LOS	F	F	B	F	D	A	E	C	F	C
Approach Delay		181.1			48.0			38.9		635.9
Approach LOS		F			D			D		F

Intersection Summary

Cycle Length: 120  
 Actuated Cycle Length: 120  
 Natural Cycle: 150  
 Control Type: Actuated-Uncoordinated  
 Maximum v/c Ratio: 3.08  
 Intersection Signal Delay: 222.6  
 Intersection LOS: F  
 Intersection Capacity Utilization 114.2%  
 ICU Level of Service H  
 Analysis Period (min) 15  
 dr Defacto Right Lane. Recode with 1 though lane as a right lane.

Splits and Phases: 3: Harvill Av. & Cajalco Exwy./Ramona Exwy.

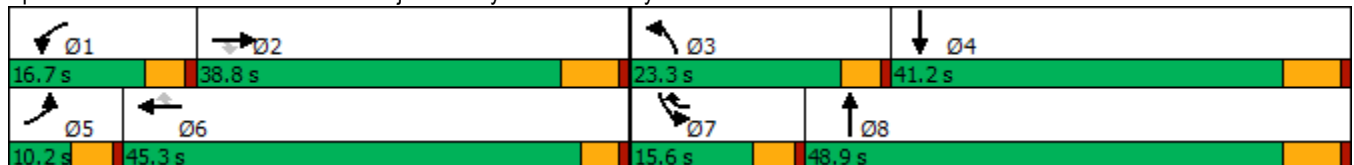

HCM 6th Signalized Intersection Summary  
 3: Harvill Av. & Cajalco Exwy./Ramona Exwy.

MFBC Building 17 (JN 13697)

09/23/2022



Movement	EBL	EBT	EBR	WBL	WBT	WBR	NBL	NBT	NBR	SBL	SBT	SBR
Lane Configurations	↘	↑↑	↗	↘↗	↑↑	↗	↘↗	↑↑		↘↗	↑↑	
Traffic Volume (veh/h)	125	1238	297	350	929	477	312	241	591	920	321	176
Future Volume (veh/h)	125	1238	297	350	929	477	312	241	591	920	321	176
Initial Q (Qb), veh	0	0	0	0	0	0	0	0	0	0	0	0
Ped-Bike Adj(A_pbT)	1.00		1.00	1.00		1.00	1.00		1.00	1.00		1.00
Parking Bus, Adj	1.00	1.00	1.00	1.00	1.00	1.00	1.00	1.00	1.00	1.00	1.00	1.00
Work Zone On Approach		No			No			No			No	
Adj Sat Flow, veh/h/ln	1900	1900	1900	1900	1900	1900	1900	1900	1900	1900	1900	1900
Adj Flow Rate, veh/h	134	1331	206	376	999	433	335	259	567	989	345	178
Peak Hour Factor	0.93	0.93	0.93	0.93	0.93	0.93	0.93	0.93	0.93	0.93	0.93	0.93
Percent Heavy Veh, %	0	0	0	0	0	0	0	0	0	0	0	0
Cap, veh/h	84	981	437	354	1176	672	396	642	573	322	776	393
Arrive On Green	0.05	0.27	0.27	0.10	0.33	0.33	0.11	0.36	0.36	0.09	0.33	0.33
Sat Flow, veh/h	1810	3610	1610	3510	3610	1610	3510	1805	1610	3510	2319	1174
Grp Volume(v), veh/h	134	1331	206	376	999	433	335	259	567	989	267	256
Grp Sat Flow(s),veh/h/ln	1810	1805	1610	1755	1805	1610	1755	1805	1610	1755	1805	1689
Q Serve(g_s), s	5.6	32.6	12.8	12.1	31.0	25.7	11.2	12.9	42.0	11.0	13.9	14.3
Cycle Q Clear(g_c), s	5.6	32.6	12.8	12.1	31.0	25.7	11.2	12.9	42.0	11.0	13.9	14.3
Prop In Lane	1.00		1.00	1.00		1.00	1.00		1.00	1.00		0.70
Lane Grp Cap(c), veh/h	84	981	437	354	1176	672	396	642	573	322	604	565
V/C Ratio(X)	1.59	1.36	0.47	1.06	0.85	0.64	0.85	0.40	0.99	3.07	0.44	0.45
Avail Cap(c_a), veh/h	84	981	437	354	1227	695	547	642	573	322	604	565
HCM Platoon Ratio	1.00	1.00	1.00	1.00	1.00	1.00	1.00	1.00	1.00	1.00	1.00	1.00
Upstream Filter(I)	1.00	1.00	1.00	1.00	1.00	1.00	1.00	1.00	1.00	1.00	1.00	1.00
Uniform Delay (d), s/veh	57.2	43.7	36.5	53.9	37.7	27.8	52.2	29.1	38.4	54.5	31.2	31.3
Incr Delay (d2), s/veh	312.7	167.4	0.8	65.3	5.6	2.0	6.5	1.9	35.1	941.2	2.3	2.6
Initial Q Delay(d3),s/veh	0.0	0.0	0.0	0.0	0.0	0.0	0.0	0.0	0.0	0.0	0.0	0.0
%ile BackOfQ(50%),veh/ln	9.8	36.6	4.9	8.4	13.8	9.6	5.1	5.7	21.1	46.8	6.2	6.0
Unsig. Movement Delay, s/veh												
LnGrp Delay(d),s/veh	369.9	211.1	37.3	119.2	43.3	29.8	58.7	30.9	73.6	995.7	33.5	33.9
LnGrp LOS	F	F	D	F	D	C	E	C	E	F	C	C
Approach Vol, veh/h		1671			1808			1161			1512	
Approach Delay, s/veh		202.4			55.9			59.8			663.0	
Approach LOS		F			E			E			F	
Timer - Assigned Phs	1	2	3	4	5	6	7	8				
Phs Duration (G+Y+Rc), s	16.7	38.8	18.1	46.4	10.2	45.3	15.6	48.9				
Change Period (Y+Rc), s	4.6	6.2	4.6	6.2	4.6	* 6.2	4.6	6.2				
Max Green Setting (Gmax), s	12.1	32.6	18.7	35.0	5.6	* 41	11.0	42.7				
Max Q Clear Time (g_c+I1), s	14.1	34.6	13.2	16.3	7.6	33.0	13.0	44.0				
Green Ext Time (p_c), s	0.0	0.0	0.3	2.6	0.0	4.5	0.0	0.0				

Intersection Summary

HCM 6th Ctrl Delay	245.6
HCM 6th LOS	F

Notes

\* HCM 6th computational engine requires equal clearance times for the phases crossing the barrier.



Timings  
4: I-215 SB Ramps & Ramona Exwy.

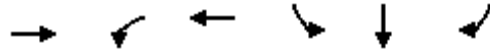

Lane Group	EBT	WBL	WBT	SBL	SBT	SBR
Lane Configurations	↑↑	↖	↑↑	↖	↖	↖
Traffic Volume (vph)	1622	844	1240	2002	8	418
Future Volume (vph)	1622	844	1240	2002	8	418
Turn Type	NA	Prot	NA	Split	NA	Perm
Protected Phases	2	1	6	4	4	
Permitted Phases						4
Detector Phase	2	1	6	4	4	4
Switch Phase						
Minimum Initial (s)	5.0	5.0	5.0	5.0	5.0	5.0
Minimum Split (s)	11.0	9.5	31.0	10.5	10.5	10.5
Total Split (s)	44.0	27.0	71.0	39.0	39.0	39.0
Total Split (%)	40.0%	24.5%	64.5%	35.5%	35.5%	35.5%
Yellow Time (s)	5.0	3.5	5.0	4.5	4.5	4.5
All-Red Time (s)	1.0	1.0	1.0	1.0	1.0	1.0
Lost Time Adjust (s)	0.0	0.0	0.0	0.0	0.0	0.0
Total Lost Time (s)	6.0	4.5	6.0	5.5	5.5	5.5
Lead/Lag	Lag	Lead				
Lead-Lag Optimize?	Yes	Yes				
Recall Mode	C-Max	None	C-Max	Max	Max	Max
Act Effct Green (s)	38.0	22.5	65.0	33.5	33.5	33.5
Actuated g/C Ratio	0.35	0.20	0.59	0.30	0.30	0.30
v/c Ratio	2.04	2.31	0.59	1.94	1.95	0.78
Control Delay	493.0	612.2	3.7	453.7	458.8	39.8
Queue Delay	0.7	0.0	0.8	28.8	28.8	0.0
Total Delay	493.7	612.2	4.5	482.6	487.6	39.8
LOS	F	F	A	F	F	D
Approach Delay	493.7		250.6		408.5	
Approach LOS	F		F		F	

Intersection Summary

Cycle Length: 110  
 Actuated Cycle Length: 110  
 Offset: 34 (31%), Referenced to phase 2:EBT and 6:WBT, Start of Yellow  
 Natural Cycle: 150  
 Control Type: Actuated-Coordinated  
 Maximum v/c Ratio: 2.31  
 Intersection Signal Delay: 392.2  
 Intersection LOS: F  
 Intersection Capacity Utilization 280.5%  
 ICU Level of Service H  
 Analysis Period (min) 15

Splits and Phases: 4: I-215 SB Ramps & Ramona Exwy.



HCM 6th Signalized Intersection Summary  
 4: I-215 SB Ramps & Ramona Exwy.

MFBC Building 17 (JN 13697)

09/23/2022



Movement	EBL	EBT	EBR	WBL	WBT	WBR	NBL	NBT	NBR	SBL	SBT	SBR
Lane Configurations		↑↑		↖	↑↑					↘	↖	↗
Traffic Volume (veh/h)	0	1622	899	844	1240	0	0	0	0	2002	8	418
Future Volume (veh/h)	0	1622	899	844	1240	0	0	0	0	2002	8	418
Initial Q (Qb), veh	0	0	0	0	0	0				0	0	0
Ped-Bike Adj(A_pbT)	1.00		1.00	1.00		1.00				1.00		1.00
Parking Bus, Adj	1.00	1.00	1.00	1.00	1.00	1.00				1.00	1.00	1.00
Work Zone On Approach		No			No						No	
Adj Sat Flow, veh/h/ln	0	1900	1900	1900	1900	0				1900	1900	1900
Adj Flow Rate, veh/h	0	1638	800	853	1253	0				2028	0	363
Peak Hour Factor	0.99	0.99	0.99	0.99	0.99	0.99				0.99	0.99	0.99
Percent Heavy Veh, %	0	0	0	0	0	0				0	0	0
Cap, veh/h	0	836	377	370	2133	0				1102	0	490
Arrive On Green	0.00	0.35	0.35	0.12	0.35	0.00				0.30	0.00	0.30
Sat Flow, veh/h	0	2514	1090	1810	3705	0				3619	0	1610
Grp Volume(v), veh/h	0	1188	1250	853	1253	0				2028	0	363
Grp Sat Flow(s),veh/h/ln	0	1805	1704	1810	1805	0				1810	0	1610
Q Serve(g_s), s	0.0	38.0	38.0	22.5	31.1	0.0				33.5	0.0	22.3
Cycle Q Clear(g_c), s	0.0	38.0	38.0	22.5	31.1	0.0				33.5	0.0	22.3
Prop In Lane	0.00		0.64	1.00		0.00				1.00		1.00
Lane Grp Cap(c), veh/h	0	624	589	370	2133	0				1102	0	490
V/C Ratio(X)	0.00	1.90	2.12	2.30	0.59	0.00				1.84	0.00	0.74
Avail Cap(c_a), veh/h	0	624	589	370	2133	0				1102	0	490
HCM Platoon Ratio	1.00	1.00	1.00	0.60	0.60	1.00				1.00	1.00	1.00
Upstream Filter(I)	0.00	0.09	0.09	0.09	0.09	0.00				1.00	0.00	1.00
Uniform Delay (d), s/veh	0.0	36.0	36.0	48.2	24.6	0.0				38.3	0.0	34.3
Incr Delay (d2), s/veh	0.0	407.7	506.4	587.8	0.1	0.0				381.6	0.0	9.7
Initial Q Delay(d3),s/veh	0.0	0.0	0.0	0.0	0.0	0.0				0.0	0.0	0.0
%ile BackOfQ(50%),veh/ln	0.0	86.1	97.4	70.8	13.8	0.0				72.4	0.0	9.6
Unsig. Movement Delay, s/veh												
LnGrp Delay(d),s/veh	0.0	443.7	542.4	636.1	24.7	0.0				419.8	0.0	44.0
LnGrp LOS	A	F	F	F	C	A				F	A	D
Approach Vol, veh/h		2438			2106						2391	
Approach Delay, s/veh		494.3			272.3						362.7	
Approach LOS		F			F						F	
Timer - Assigned Phs	1	2		4		6						
Phs Duration (G+Y+Rc), s	27.0	44.0		39.0		71.0						
Change Period (Y+Rc), s	4.5	6.0		5.5		6.0						
Max Green Setting (Gmax), s	22.5	38.0		33.5		65.0						
Max Q Clear Time (g_c+I1), s	24.5	40.0		35.5		33.1						
Green Ext Time (p_c), s	0.0	0.0		0.0		6.0						

Intersection Summary

HCM 6th Ctrl Delay	381.5
HCM 6th LOS	F

Notes

User approved volume balancing among the lanes for turning movement.

Timings  
5: I-215 NB Ramps & Ramona Exwy.



Lane Group	EBL	EBT	WBT	WBR	NBL	NBT	NBR
Lane Configurations	↶	↷	↶	↷	↶	↷	↷
Traffic Volume (vph)	695	2932	1497	1722	590	4	561
Future Volume (vph)	695	2932	1497	1722	590	4	561
Turn Type	Prot	NA	NA	Perm	Split	NA	Perm
Protected Phases	5	2	6		8	8	
Permitted Phases				6			8
Detector Phase	5	2	6	6	8	8	8
Switch Phase							
Minimum Initial (s)	5.0	5.0	5.0	5.0	5.0	5.0	5.0
Minimum Split (s)	9.5	11.0	26.0	26.0	10.5	10.5	10.5
Total Split (s)	23.0	68.0	45.0	45.0	42.0	42.0	42.0
Total Split (%)	20.9%	61.8%	40.9%	40.9%	38.2%	38.2%	38.2%
Yellow Time (s)	3.5	5.0	5.0	5.0	4.5	4.5	4.5
All-Red Time (s)	1.0	1.0	1.0	1.0	1.0	1.0	1.0
Lost Time Adjust (s)	0.0	0.0	0.0	0.0	0.0	0.0	0.0
Total Lost Time (s)	4.5	6.0	6.0	6.0	5.5	5.5	5.5
Lead/Lag	Lead		Lag	Lag			
Lead-Lag Optimize?	Yes		Yes	Yes			
Recall Mode	None	C-Max	C-Max	C-Max	None	None	None
Act Effct Green (s)	18.5	62.0	39.0	39.0	36.5	36.5	36.5
Actuated g/C Ratio	0.17	0.56	0.35	0.35	0.33	0.33	0.33
v/c Ratio	2.44	1.53	1.25	1.79	0.55	0.56	1.02
Control Delay	669.0	265.7	149.6	377.9	34.5	34.7	75.3
Queue Delay	0.0	2.3	0.0	0.0	0.0	0.0	0.0
Total Delay	669.0	268.0	149.6	377.9	34.5	34.7	75.3
LOS	F	F	F	F	C	C	E
Approach Delay		344.8	271.7			54.4	
Approach LOS		F	F			D	

Intersection Summary

Cycle Length: 110  
 Actuated Cycle Length: 110  
 Offset: 0 (0%), Referenced to phase 2:EBT and 6:WBT, Start of Yellow, Master Intersection  
 Natural Cycle: 150  
 Control Type: Actuated-Coordinated  
 Maximum v/c Ratio: 2.44  
 Intersection Signal Delay: 273.5  
 Intersection LOS: F  
 Intersection Capacity Utilization 280.5%  
 ICU Level of Service H  
 Analysis Period (min) 15

Splits and Phases: 5: I-215 NB Ramps & Ramona Exwy.

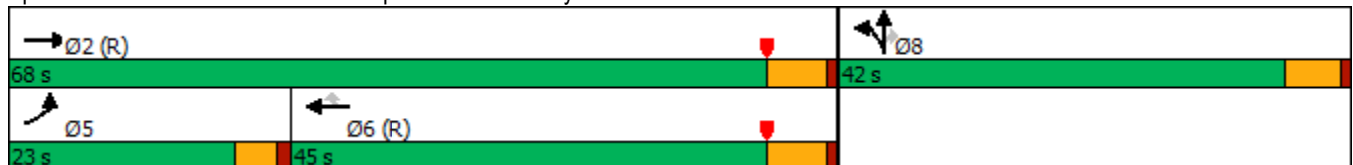

HCM 6th Signalized Intersection Summary  
5: I-215 NB Ramps & Ramona Exwy.

MFBC Building 17 (JN 13697)

09/23/2022



Movement	EBL	EBT	EBR	WBL	WBT	WBR	NBL	NBT	NBR	SBL	SBT	SBR
Lane Configurations	↘	↑↑			↑↑	↗	↘	↗	↗			
Traffic Volume (veh/h)	695	2932	0	0	1497	1722	590	4	561	0	0	0
Future Volume (veh/h)	695	2932	0	0	1497	1722	590	4	561	0	0	0
Initial Q (Qb), veh	0	0	0	0	0	0	0	0	0			
Ped-Bike Adj(A_pbT)	1.00		1.00	1.00		1.00	1.00		1.00			
Parking Bus, Adj	1.00	1.00	1.00	1.00	1.00	1.00	1.00	1.00	1.00			
Work Zone On Approach		No			No			No				
Adj Sat Flow, veh/h/ln	1900	1900	0	0	1900	1900	1900	1900	1900			
Adj Flow Rate, veh/h	739	3119	0	0	1593	1682	631	0	516			
Peak Hour Factor	0.94	0.94	0.94	0.94	0.94	0.94	0.94	0.94	0.94			
Percent Heavy Veh, %	0	0	0	0	0	0	0	0	0			
Cap, veh/h	304	2035	0	0	1280	569	1201	0	534			
Arrive On Green	0.17	0.56	0.00	0.00	0.35	0.35	0.33	0.00	0.33			
Sat Flow, veh/h	1810	3705	0	0	3705	1606	3619	0	1610			
Grp Volume(v), veh/h	739	3119	0	0	1593	1682	631	0	516			
Grp Sat Flow(s),veh/h/ln	1810	1805	0	0	1805	1606	1810	0	1610			
Q Serve(g_s), s	18.5	62.0	0.0	0.0	39.0	39.0	15.5	0.0	34.7			
Cycle Q Clear(g_c), s	18.5	62.0	0.0	0.0	39.0	39.0	15.5	0.0	34.7			
Prop In Lane	1.00		0.00	0.00		1.00	1.00		1.00			
Lane Grp Cap(c), veh/h	304	2035	0	0	1280	569	1201	0	534			
V/C Ratio(X)	2.43	1.53	0.00	0.00	1.24	2.95	0.53	0.00	0.97			
Avail Cap(c_a), veh/h	304	2035	0	0	1280	569	1201	0	534			
HCM Platoon Ratio	1.00	1.00	1.00	1.00	1.00	1.00	1.00	1.00	1.00			
Upstream Filter(I)	0.09	0.09	0.00	0.00	1.00	1.00	1.00	0.00	1.00			
Uniform Delay (d), s/veh	45.8	24.0	0.0	0.0	35.5	35.5	29.7	0.0	36.1			
Incr Delay (d2), s/veh	643.6	240.0	0.0	0.0	116.8	884.0	0.4	0.0	30.3			
Initial Q Delay(d3),s/veh	0.0	0.0	0.0	0.0	0.0	0.0	0.0	0.0	0.0			
%ile BackOfQ(50%),veh/ln	62.3	90.1	0.0	0.0	36.6	153.9	6.5	0.0	17.3			
Unsig. Movement Delay, s/veh												
LnGrp Delay(d),s/veh	689.4	264.0	0.0	0.0	152.3	919.5	30.2	0.0	66.4			
LnGrp LOS	F	F	A	A	F	F	C	A	E			
Approach Vol, veh/h		3858			3275			1147				
Approach Delay, s/veh		345.5			546.3			46.5				
Approach LOS		F			F			D				
Timer - Assigned Phs		2			5	6		8				
Phs Duration (G+Y+Rc), s		68.0			23.0	45.0		42.0				
Change Period (Y+Rc), s		6.0			4.5	6.0		5.5				
Max Green Setting (Gmax), s		62.0			18.5	39.0		36.5				
Max Q Clear Time (g_c+I1), s		64.0			20.5	41.0		36.7				
Green Ext Time (p_c), s		0.0			0.0	0.0		0.0				

Intersection Summary

HCM 6th Ctrl Delay	383.5
HCM 6th LOS	F

Notes

User approved volume balancing among the lanes for turning movement.

## **APPENDIX 6.2: EAPC (2025) CONDITIONS TRAFFIC SIGNAL WARRANT ANALYSIS WORKSHEETS**

This Page Intentionally Left Blank

### Figure 4C-103 (CA). Traffic Signal Warrants Worksheet (Average Traffic Estimate Form)

<u>DIST</u>	<u>CO</u>	<u>RTE</u>	<u>PM</u>	<u>CALC</u>	<u>TRAFFIC CONDITIONS</u>	<u>EAPC (2025)</u>
Jurisdiction: <u>County of Riverside</u>				<u>CS</u>		<u>DATE 09/23/22</u>
Major Street: <u>Harvill Av.</u>				<u>CS</u>		<u>DATE 09/23/22</u>
Minor Street: <u>Driveway 1</u>					Critical Approach Speed (Major) <u>25</u> mph	
					Critical Approach Speed (Minor) <u>25</u> mph	
Major Street Approach Lanes =		<u>2</u>	lane		Minor Street Approach Lanes =	<u>1</u> lane
Major Street Future ADT =		<u>24,816</u>	vpd		Minor Street Future ADT =	<u>76</u> vpd
Speed limit or critical speed on major street traffic > 64 km/h (40 mph); .....						<input type="text"/>
						or
In built up area of isolated community of < 10,000 population .....						<input type="text"/>

**URBAN (U)**

**(Based on Estimated Average Daily Traffic - See Note)**

<u>URBAN</u>	<u>RURAL</u>	Minimum Requirements EADT			
<b>XX</b>		Vehicles Per Day on Major Street (Total of Both Approaches)		Vehicles Per Day on Higher-Volume Minor Street Approach (One Direction Only)	
<b>CONDITION A - Minimum Vehicular Volume</b>	<b>Not Satisfied</b>				
<u>Satisfied</u>	<b>XX</b>				
Number of lanes for moving traffic on each approach	Number of lanes for moving traffic on each approach	<u>Urban</u>	<u>Rural</u>	<u>Urban</u>	<u>Rural</u>
<u>Major Street</u>	<u>Minor Street</u>				
1	1	8,000	5,600	2,400	1,680
2 + <b>24,816</b>	1 <b>76</b>	9,600 *	6,720	2,400	1,680
2 +	2 +	9,600	6,720	3,200	2,240
1	2 +	8,000	5,600	3,200	2,240
<b>CONDITION B - Interruption of Continuous Traffic</b>	<b>Not Satisfied</b>	Vehicles Per Day on Major Street (Total of Both Approaches)		Vehicles Per Day on Higher-Volume Minor Street Approach (One Direction Only)	
<u>Satisfied</u>	<b>XX</b>				
Number of lanes for moving traffic on each approach	Number of lanes for moving traffic on each approach	<u>Urban</u>	<u>Rural</u>	<u>Urban</u>	<u>Rural</u>
<u>Major Street</u>	<u>Minor Street</u>				
1	1	12,000	8,400	1,200	850
2 + <b>24,816</b>	1 <b>76</b>	14,400 *	10,080	1,200	850
2 +	2 +	14,400	10,080	1,600	1,120
1	2 +	12,000	8,400	1,600	1,120
<b>Combination of CONDITIONS A + B</b>	<b>Not Satisfied</b>	2 CONDITIONS 80%		2 CONDITIONS 80%	
<u>Satisfied</u>	<b>XX</b>				
No one condition satisfied, but following conditions fulfilled 80% of more .....	<b>A</b>				
	<b>3%</b>				
	<b>B</b>				
	<b>6%</b>				

**Note: To be used only for NEW INTERSECTIONS or other locations where it is not reasonable to count actual traffic volumes.**

The satisfaction of a traffic signal warrant or warrants shall not in itself require the installation of a traffic control signal.



### Figure 4C-4. Warrant 3, Peak Hour (70% Factor)

(COMMUNITY LESS THAN 10,000 POPULATION OR ABOVE 64 km/h OR ABOVE 40 mph ON MAJOR STREET)

Traffic Conditions = **EAPC (2025) Conditions - Weekday PM Peak Hour**

Major Street Name = **Harvill Avenue**

Total of Both Approaches (VPH) = **2113**  
 Number of Approach Lanes Major Street = **2**

Minor Street Name = **America's Tire**

High Volume Approach (VPH) = **63**  
 Number of Approach Lanes Minor Street = **1**

**SIGNAL WARRANT NOT SATISFIED**

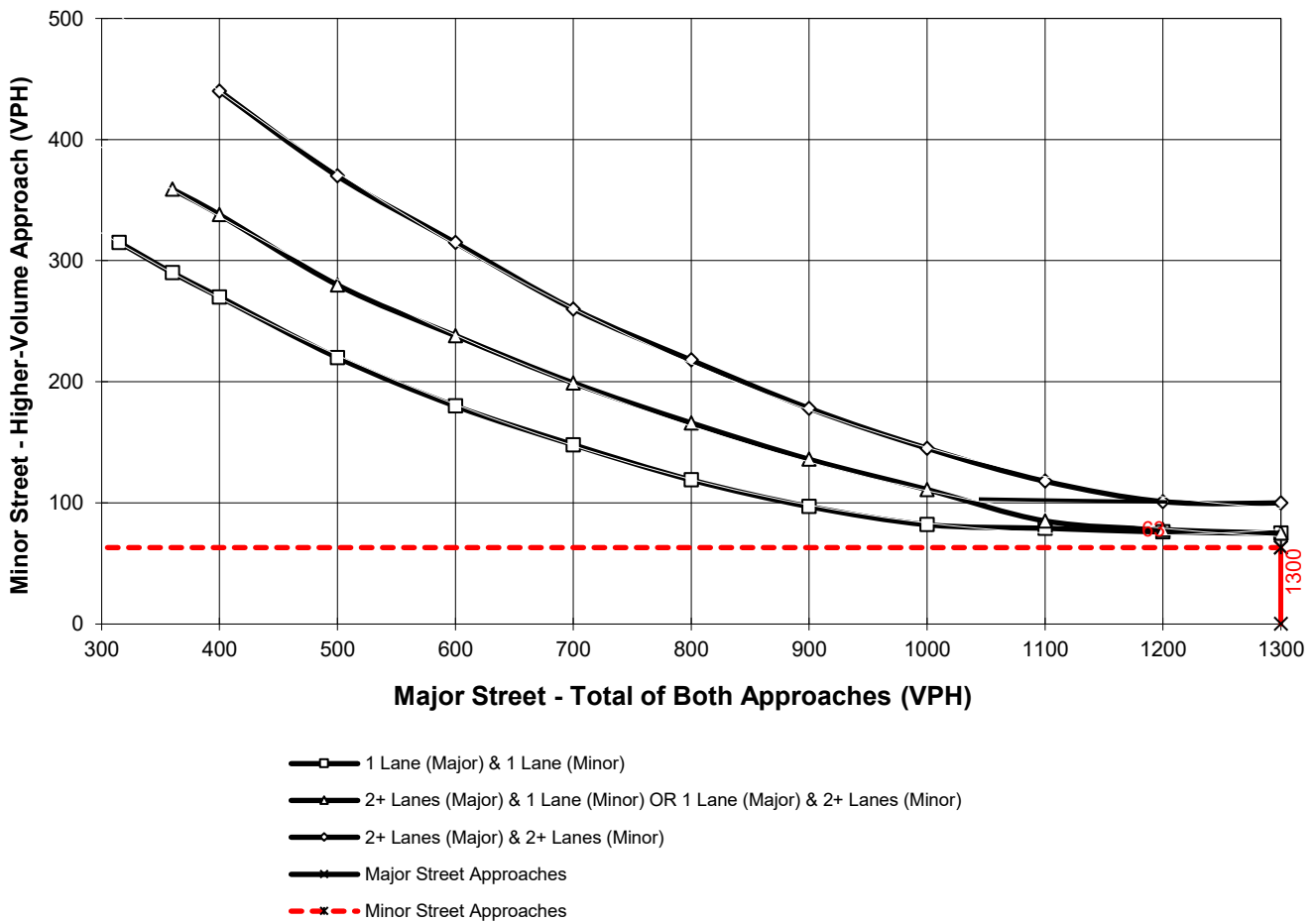

\*Note: 100 vph applies as the lower threshold for a minor-street approach with two or more lanes and 75 vph applies as the lower threshold for a minor-street approach with one lane



**APPENDIX 6.3: EAPC (2025) CONDITIONS FREEWAY OFF-RAMP  
QUEUING ANALYSIS WORKSHEETS**

This Page Intentionally Left Blank

## 4: I-215 SB Ramps &amp; Ramona Exwy.

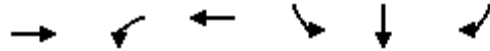

Lane Group	EBT	WBL	WBT	SBL	SBT	SBR
Lane Group Flow (vph)	1283	558	1915	942	945	796
v/c Ratio	1.02	1.51	0.90	1.80	1.81	1.47
Control Delay	64.4	260.2	10.2	396.2	397.2	248.0
Queue Delay	6.9	0.0	46.1	12.5	12.5	0.0
Total Delay	71.2	260.2	56.3	408.7	409.7	248.0
Queue Length 50th (ft)	~476	~525	262	~1055	~1060	~740
Queue Length 95th (ft)	#614	m#375	m390	#1312	#1316	#980
Internal Link Dist (ft)	1408		344		1111	
Turn Bay Length (ft)		100		510		510
Base Capacity (vph)	1253	369	2133	522	523	543
Starvation Cap Reductn	0	0	406	0	0	0
Spillback Cap Reductn	24	0	0	340	341	0
Storage Cap Reductn	0	0	0	0	0	0
Reduced v/c Ratio	1.04	1.51	1.11	5.18	5.19	1.47

## Intersection Summary

~ Volume exceeds capacity, queue is theoretically infinite.

Queue shown is maximum after two cycles.

# 95th percentile volume exceeds capacity, queue may be longer.

Queue shown is maximum after two cycles.

m Volume for 95th percentile queue is metered by upstream signal.

Queues  
5: I-215 NB Ramps & Ramona Exwy.



Lane Group	EBL	EBT	WBT	WBR	NBL	NBT	NBR
Lane Group Flow (vph)	330	2388	1567	1516	467	471	833
v/c Ratio	1.09	1.17	1.23	1.44	0.82	0.83	1.42
Control Delay	95.0	104.0	141.1	222.9	47.3	47.7	229.0
Queue Delay	0.0	2.4	0.9	0.0	0.0	0.0	0.0
Total Delay	95.0	106.4	142.0	222.9	47.3	47.7	229.0
Queue Length 50th (ft)	~249	~1087	~718	~1107	316	320	~765
Queue Length 95th (ft)	m227	m606	#857	#1374	#493	#500	#1008
Internal Link Dist (ft)		344	532			1162	
Turn Bay Length (ft)	105			200			500
Base Capacity (vph)	303	2034	1279	1050	569	570	585
Starvation Cap Reductn	0	999	0	0	0	0	0
Spillback Cap Reductn	0	0	241	0	0	0	0
Storage Cap Reductn	0	0	0	0	0	0	0
Reduced v/c Ratio	1.09	2.31	1.51	1.44	0.82	0.83	1.42

Intersection Summary

- ~ Volume exceeds capacity, queue is theoretically infinite.  
Queue shown is maximum after two cycles.
- # 95th percentile volume exceeds capacity, queue may be longer.  
Queue shown is maximum after two cycles.
- m Volume for 95th percentile queue is metered by upstream signal.

## 4: I-215 SB Ramps &amp; Ramona Exwy.

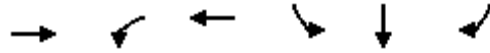

Lane Group	EBT	WBL	WBT	SBL	SBT	SBR
Lane Group Flow (vph)	2546	853	1253	1011	1019	422
v/c Ratio	2.04	2.31	0.59	1.94	1.95	0.78
Control Delay	493.0	612.2	3.7	453.7	458.8	39.8
Queue Delay	0.7	0.0	0.8	28.8	28.8	0.0
Total Delay	493.7	612.2	4.5	482.6	487.6	39.8
Queue Length 50th (ft)	~1480	~953	30	~1162	~1173	227
Queue Length 95th (ft)	#1616	m#708	m49	#1423	#1434	#377
Internal Link Dist (ft)	1408		344		1111	
Turn Bay Length (ft)		100		510		510
Base Capacity (vph)	1249	369	2133	522	523	543
Starvation Cap Reductn	0	0	530	0	0	0
Spillback Cap Reductn	182	0	0	438	439	0
Storage Cap Reductn	0	0	0	0	0	0
Reduced v/c Ratio	2.39	2.31	0.78	12.04	12.13	0.78

## Intersection Summary

~ Volume exceeds capacity, queue is theoretically infinite.

Queue shown is maximum after two cycles.

# 95th percentile volume exceeds capacity, queue may be longer.

Queue shown is maximum after two cycles.

m Volume for 95th percentile queue is metered by upstream signal.



Lane Group	EBL	EBT	WBT	WBR	NBL	NBT	NBR
Lane Group Flow (vph)	739	3119	1593	1832	314	318	597
v/c Ratio	2.44	1.53	1.25	1.79	0.55	0.56	1.02
Control Delay	669.0	265.7	149.6	377.9	34.5	34.7	75.3
Queue Delay	0.0	2.3	0.0	0.0	0.0	0.0	0.0
Total Delay	669.0	268.0	149.6	377.9	34.5	34.7	75.3
Queue Length 50th (ft)	~782	~1599	~738	~1615	189	192	~411
Queue Length 95th (ft)	m#298	m608	#877	#1885	286	289	#631
Internal Link Dist (ft)		344	532			1162	
Turn Bay Length (ft)	105			200			500
Base Capacity (vph)	303	2034	1279	1023	569	570	585
Starvation Cap Reductn	0	974	0	0	0	0	0
Spillback Cap Reductn	0	0	0	0	0	0	0
Storage Cap Reductn	0	0	0	0	0	0	0
Reduced v/c Ratio	2.44	2.94	1.25	1.79	0.55	0.56	1.02

Intersection Summary

- ~ Volume exceeds capacity, queue is theoretically infinite.  
Queue shown is maximum after two cycles.
- # 95th percentile volume exceeds capacity, queue may be longer.  
Queue shown is maximum after two cycles.
- m Volume for 95th percentile queue is metered by upstream signal.

## **APPENDIX 6.4: EAPC (2025) CONDITIONS INTERSECTION OPERATIONS ANALYSIS WORKSHEETS WITH IMPROVEMENTS**

This Page Intentionally Left Blank



Timings  
3: Harvill Av. & Cajalco Exwy./Ramona Exwy.

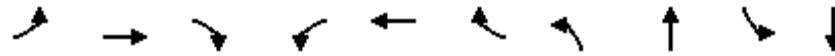

Lane Group	EBL	EBT	EBR	WBL	WBT	WBR	NBL	NBT	SBL	SBT
Lane Configurations	↘	↑↑↑	↗	↘↗	↑↑↑	↗	↘↗	↑↘	↘↗	↑↘
Traffic Volume (vph)	191	841	218	640	1130	761	373	434	427	230
Future Volume (vph)	191	841	218	640	1130	761	373	434	427	230
Turn Type	Prot	NA	Perm	Prot	NA	pm+ov	Prot	NA	Prot	NA
Protected Phases	5	2		1	6	7	3	8	7	4
Permitted Phases			2			6				
Detector Phase	5	2	2	1	6	7	3	8	7	4
Switch Phase										
Minimum Initial (s)	5.0	10.0	10.0	5.0	10.0	5.0	5.0	10.0	5.0	10.0
Minimum Split (s)	9.6	36.2	36.2	9.6	32.5	9.6	9.6	16.2	9.6	41.2
Total Split (s)	29.0	36.8	36.8	25.0	32.8	28.0	17.0	30.2	28.0	41.2
Total Split (%)	24.2%	30.7%	30.7%	20.8%	27.3%	23.3%	14.2%	25.2%	23.3%	34.3%
Yellow Time (s)	3.6	5.2	5.2	3.6	3.5	3.6	3.6	5.2	3.6	5.2
All-Red Time (s)	1.0	1.0	1.0	1.0	1.0	1.0	1.0	1.0	1.0	1.0
Lost Time Adjust (s)	0.0	0.0	0.0	0.0	0.0	0.0	0.0	0.0	0.0	0.0
Total Lost Time (s)	4.6	6.2	6.2	4.6	4.5	4.6	4.6	6.2	4.6	6.2
Lead/Lag	Lead	Lag	Lag	Lead	Lag	Lead	Lead	Lag	Lead	Lag
Lead-Lag Optimize?	Yes	Yes	Yes	Yes	Yes	Yes	Yes	Yes	Yes	Yes
Recall Mode	None	None	None	None	None	None	None	Max	None	Max
Act Effct Green (s)	17.4	26.1	26.1	20.4	30.8	58.0	12.4	24.8	22.6	35.0
Actuated g/C Ratio	0.15	0.23	0.23	0.18	0.27	0.50	0.11	0.21	0.20	0.30
v/c Ratio	0.76	0.70	0.43	1.08	0.80	0.92	1.04	0.86	0.65	0.29
Control Delay	64.5	44.3	7.1	104.6	44.8	38.6	105.9	50.5	48.1	27.6
Queue Delay	0.0	0.0	0.0	0.0	0.0	0.0	0.0	0.0	0.0	0.0
Total Delay	64.5	44.3	7.1	104.6	44.8	38.6	105.9	50.5	48.1	27.6
LOS	E	D	A	F	D	D	F	D	D	C
Approach Delay		40.9			58.1			70.3		39.4
Approach LOS		D			E			E		D

Intersection Summary

Cycle Length: 120  
 Actuated Cycle Length: 115.6  
 Natural Cycle: 120  
 Control Type: Actuated-Uncoordinated  
 Maximum v/c Ratio: 1.08  
 Intersection Signal Delay: 54.0  
 Intersection LOS: D  
 Intersection Capacity Utilization 90.2%  
 ICU Level of Service E  
 Analysis Period (min) 15

Splits and Phases: 3: Harvill Av. & Cajalco Exwy./Ramona Exwy.

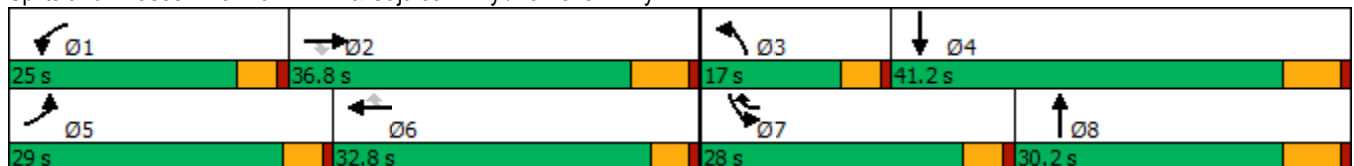

HCM 6th Signalized Intersection Summary  
 3: Harvill Av. & Cajalco Exwy./Ramona Exwy.

MFBC Building 17 (JN 13697)

09/23/2022



Movement	EBL	EBT	EBR	WBL	WBT	WBR	NBL	NBT	NBR	SBL	SBT	SBR
Lane Configurations	↘	↑↑↑	↗	↘↗	↑↑↑	↗	↘↗	↑↑		↘↗	↑↑	
Traffic Volume (veh/h)	191	841	218	640	1130	761	373	434	240	427	230	83
Future Volume (veh/h)	191	841	218	640	1130	761	373	434	240	427	230	83
Initial Q (Qb), veh	0	0	0	0	0	0	0	0	0	0	0	0
Ped-Bike Adj(A_pbT)	1.00		1.00	1.00		1.00	1.00		0.99	1.00		1.00
Parking Bus, Adj	1.00	1.00	1.00	1.00	1.00	1.00	1.00	1.00	1.00	1.00	1.00	1.00
Work Zone On Approach		No			No			No			No	
Adj Sat Flow, veh/h/ln	1900	1900	1900	1900	1900	1900	1900	1900	1900	1900	1900	1900
Adj Flow Rate, veh/h	205	904	76	688	1215	452	401	467	134	459	247	46
Peak Hour Factor	0.93	0.93	0.93	0.93	0.93	0.93	0.93	0.93	0.93	0.93	0.93	0.93
Percent Heavy Veh, %	0	0	0	0	0	0	0	0	0	0	0	0
Cap, veh/h	236	1181	333	655	1469	651	398	776	221	531	970	178
Arrive On Green	0.13	0.21	0.21	0.18	0.26	0.26	0.11	0.27	0.27	0.15	0.31	0.31
Sat Flow, veh/h	1810	5700	1610	3619	5700	1610	3619	2835	807	3619	3124	573
Grp Volume(v), veh/h	205	904	76	688	1215	452	401	312	289	459	149	144
Grp Sat Flow(s),veh/h/ln	1810	1900	1610	1810	1900	1610	1810	1900	1742	1810	1900	1797
Q Serve(g_s), s	12.5	16.9	4.4	20.4	22.7	26.2	12.4	16.1	16.3	14.0	6.6	6.8
Cycle Q Clear(g_c), s	12.5	16.9	4.4	20.4	22.7	26.2	12.4	16.1	16.3	14.0	6.6	6.8
Prop In Lane	1.00		1.00	1.00		1.00	1.00		0.46	1.00		0.32
Lane Grp Cap(c), veh/h	236	1181	333	655	1469	651	398	520	477	531	590	558
V/C Ratio(X)	0.87	0.77	0.23	1.05	0.83	0.69	1.01	0.60	0.61	0.86	0.25	0.26
Avail Cap(c_a), veh/h	392	1547	437	655	1469	651	398	520	477	751	590	558
HCM Platoon Ratio	1.00	1.00	1.00	1.00	1.00	1.00	1.00	1.00	1.00	1.00	1.00	1.00
Upstream Filter(I)	1.00	1.00	1.00	1.00	1.00	1.00	1.00	1.00	1.00	1.00	1.00	1.00
Uniform Delay (d), s/veh	48.1	42.1	37.2	46.2	39.5	27.8	50.2	35.6	35.7	47.0	29.1	29.2
Incr Delay (d2), s/veh	5.7	1.7	0.3	49.2	4.0	3.2	47.0	5.0	5.6	5.6	1.0	1.1
Initial Q Delay(d3),s/veh	0.0	0.0	0.0	0.0	0.0	0.0	0.0	0.0	0.0	0.0	0.0	0.0
%ile BackOfQ(50%),veh/ln	5.8	7.7	1.7	13.2	10.6	9.9	8.0	7.8	7.3	6.4	3.0	3.0
Unsig. Movement Delay, s/veh												
LnGrp Delay(d),s/veh	53.8	43.8	37.5	95.4	43.5	31.0	97.2	40.6	41.3	52.7	30.1	30.3
LnGrp LOS	D	D	D	F	D	C	F	D	D	D	C	C
Approach Vol, veh/h		1185			2355			1002			752	
Approach Delay, s/veh		45.2			56.3			63.5			43.9	
Approach LOS		D			E			E			D	
Timer - Assigned Phs	1	2	3	4	5	6	7	8				
Phs Duration (G+Y+Rc), s	25.0	29.6	17.0	41.2	19.3	35.3	21.1	37.1				
Change Period (Y+Rc), s	4.6	6.2	4.6	6.2	4.6	* 6.2	4.6	6.2				
Max Green Setting (Gmax), s	20.4	30.6	12.4	35.0	24.4	* 28	23.4	24.0				
Max Q Clear Time (g_c+I1), s	22.4	18.9	14.4	8.8	14.5	28.2	16.0	18.3				
Green Ext Time (p_c), s	0.0	4.5	0.0	1.4	0.2	0.1	0.6	1.6				

Intersection Summary

HCM 6th Ctrl Delay	53.4
HCM 6th LOS	D

Notes

\* HCM 6th computational engine requires equal clearance times for the phases crossing the barrier.

Timings  
4: I-215 SB Ramps & Ramona Exwy.

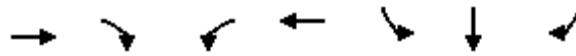

Lane Group	EBT	EBR	WBL	WBT	SBL	SBT	SBR
Lane Configurations	↑↑↑	↑	↖↗	↑↑↑	↖↗	↑	↑
Traffic Volume (vph)	785	472	547	1877	1847	2	780
Future Volume (vph)	785	472	547	1877	1847	2	780
Turn Type	NA	Perm	Prot	NA	Split	NA	Perm
Protected Phases	2		1	6	4	4	
Permitted Phases		2					4
Detector Phase	2	2	1	6	4	4	4
Switch Phase							
Minimum Initial (s)	5.0	5.0	5.0	5.0	5.0	5.0	5.0
Minimum Split (s)	11.0	11.0	9.5	31.0	10.5	10.5	10.5
Total Split (s)	27.0	27.0	26.0	53.0	67.0	67.0	67.0
Total Split (%)	22.5%	22.5%	21.7%	44.2%	55.8%	55.8%	55.8%
Yellow Time (s)	5.0	5.0	3.5	5.0	4.5	4.5	4.5
All-Red Time (s)	1.0	1.0	1.0	1.0	1.0	1.0	1.0
Lost Time Adjust (s)	0.0	0.0	0.0	0.0	0.0	0.0	0.0
Total Lost Time (s)	6.0	6.0	4.5	6.0	5.5	5.5	5.5
Lead/Lag	Lag	Lag	Lead				
Lead-Lag Optimize?	Yes	Yes	Yes				
Recall Mode	C-Max	C-Max	None	C-Max	Max	Max	Max
Act Effct Green (s)	21.5	21.5	21.0	47.0	61.5	61.5	61.5
Actuated g/C Ratio	0.18	0.18	0.18	0.39	0.51	0.51	0.51
v/c Ratio	0.78	0.71	0.89	0.86	0.68	0.67	0.93
Control Delay	53.4	10.3	83.1	34.0	24.3	26.3	42.9
Queue Delay	0.0	0.0	0.0	36.8	51.3	56.3	0.0
Total Delay	53.4	10.3	83.1	70.9	75.6	82.6	42.9
LOS	D	B	F	E	E	F	D
Approach Delay	37.2			73.6		67.5	
Approach LOS	D			E		E	

Intersection Summary

Cycle Length: 120  
 Actuated Cycle Length: 120  
 Offset: 0 (0%), Referenced to phase 2:EBT and 6:WBT, Start of Yellow  
 Natural Cycle: 70  
 Control Type: Actuated-Coordinated  
 Maximum v/c Ratio: 0.93  
 Intersection Signal Delay: 63.8  
 Intersection LOS: E  
 Intersection Capacity Utilization 166.4%  
 ICU Level of Service H  
 Analysis Period (min) 15

Splits and Phases: 4: I-215 SB Ramps & Ramona Exwy.

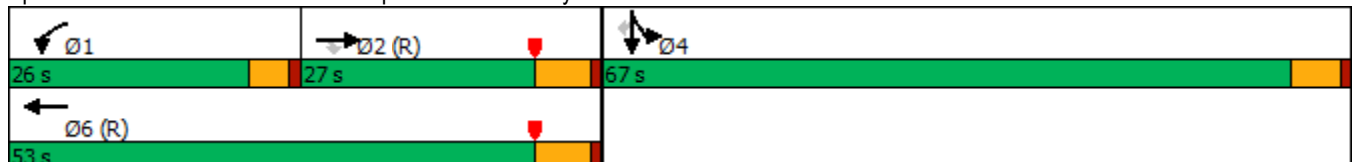

HCM 6th Signalized Intersection Summary  
 4: I-215 SB Ramps & Ramona Exwy.

MFBC Building 17 (JN 13697)

09/23/2022



Movement	EBL	EBT	EBR	WBL	WBT	WBR	NBL	NBT	NBR	SBL	SBT	SBR
Lane Configurations		↑↑↑	↗	↘↗	↑↑↑					↘↗	↖	↗
Traffic Volume (veh/h)	0	785	472	547	1877	0	0	0	0	1847	2	780
Future Volume (veh/h)	0	785	472	547	1877	0	0	0	0	1847	2	780
Initial Q (Qb), veh	0	0	0	0	0	0				0	0	0
Ped-Bike Adj(A_pbT)	1.00		0.99	1.00		1.00				1.00		1.00
Parking Bus, Adj	1.00	1.00	1.00	1.00	1.00	1.00				1.00	1.00	1.00
Work Zone On Approach		No			No						No	
Adj Sat Flow, veh/h/ln	0	1900	1900	1900	1900	0				1900	1900	1900
Adj Flow Rate, veh/h	0	801	258	558	1915	0				1886	0	413
Peak Hour Factor	0.98	0.98	0.98	0.98	0.98	0.98				0.98	0.98	0.98
Percent Heavy Veh, %	0	0	0	0	0	0				0	0	0
Cap, veh/h	0	1046	292	617	2232	0				2782	0	825
Arrive On Green	0.00	0.18	0.18	0.17	0.39	0.00				0.51	0.00	0.51
Sat Flow, veh/h	0	5700	1589	3619	5700	0				5429	0	1610
Grp Volume(v), veh/h	0	801	258	558	1915	0				1886	0	413
Grp Sat Flow(s),veh/h/ln	0	1900	1589	1810	1900	0				1810	0	1610
Q Serve(g_s), s	0.0	16.0	19.0	18.1	36.9	0.0				31.1	0.0	20.2
Cycle Q Clear(g_c), s	0.0	16.0	19.0	18.1	36.9	0.0				31.1	0.0	20.2
Prop In Lane	0.00		1.00	1.00		0.00				1.00		1.00
Lane Grp Cap(c), veh/h	0	1046	292	617	2233	0				2782	0	825
V/C Ratio(X)	0.00	0.77	0.88	0.90	0.86	0.00				0.68	0.00	0.50
Avail Cap(c_a), veh/h	0	1046	292	648	2233	0				2782	0	825
HCM Platoon Ratio	1.00	1.00	1.00	1.00	1.00	1.00				1.00	1.00	1.00
Upstream Filter(I)	0.00	0.67	0.67	0.33	0.33	0.00				1.00	0.00	1.00
Uniform Delay (d), s/veh	0.0	46.5	47.7	48.8	33.4	0.0				21.9	0.0	19.2
Incr Delay (d2), s/veh	0.0	3.6	22.2	6.2	1.6	0.0				1.3	0.0	2.2
Initial Q Delay(d3),s/veh	0.0	0.0	0.0	0.0	0.0	0.0				0.0	0.0	0.0
%ile BackOfQ(50%),veh/ln	0.0	7.6	9.0	8.4	16.2	0.0				12.6	0.0	7.5
Unsig. Movement Delay, s/veh												
LnGrp Delay(d),s/veh	0.0	50.2	70.0	55.0	35.0	0.0				23.2	0.0	21.3
LnGrp LOS	A	D	E	D	D	A				C	A	C
Approach Vol, veh/h		1059			2473						2299	
Approach Delay, s/veh		55.0			39.5						22.9	
Approach LOS		D			D						C	
Timer - Assigned Phs	1	2		4		6						
Phs Duration (G+Y+Rc), s	25.0	28.0		67.0		53.0						
Change Period (Y+Rc), s	4.5	6.0		5.5		6.0						
Max Green Setting (Gmax), s	21.5	21.0		61.5		47.0						
Max Q Clear Time (g_c+I1), s	20.1	21.0		33.1		38.9						
Green Ext Time (p_c), s	0.3	0.0		12.3		5.2						

Intersection Summary

HCM 6th Ctrl Delay	35.8
HCM 6th LOS	D

Notes

User approved volume balancing among the lanes for turning movement.

Timings  
5: I-215 NB Ramps & Ramona Exwy.



Lane Group	EBL	EBT	WBT	WBR	NBL	NBT	NBR
Lane Configurations	↶↶	↑↑↑	↶↶↶	↷	↶	↶	↷
Traffic Volume (vph)	320	2316	1520	1471	906	4	808
Future Volume (vph)	320	2316	1520	1471	906	4	808
Turn Type	Prot	NA	NA	Free	Split	NA	Perm
Protected Phases	5	2	6		8	8	
Permitted Phases				Free			8
Detector Phase	5	2	6		8	8	8
Switch Phase							
Minimum Initial (s)	5.0	5.0	5.0		5.0	5.0	5.0
Minimum Split (s)	9.5	11.0	26.0		10.5	10.5	10.5
Total Split (s)	16.0	59.0	43.0		61.0	61.0	61.0
Total Split (%)	13.3%	49.2%	35.8%		50.8%	50.8%	50.8%
Yellow Time (s)	3.5	5.0	5.0		4.5	4.5	4.5
All-Red Time (s)	1.0	1.0	1.0		1.0	1.0	1.0
Lost Time Adjust (s)	0.0	0.0	0.0		0.0	0.0	0.0
Total Lost Time (s)	4.5	6.0	6.0		5.5	5.5	5.5
Lead/Lag	Lead		Lag				
Lead-Lag Optimize?	Yes		Yes				
Recall Mode	None	C-Max	C-Max		None	None	None
Act Effct Green (s)	11.5	53.0	37.0	120.0	55.5	55.5	55.5
Actuated g/C Ratio	0.10	0.44	0.31	1.00	0.46	0.46	0.46
v/c Ratio	0.99	1.04	0.98	0.94	0.59	0.59	1.06
Control Delay	113.5	72.2	59.6	13.4	27.6	27.7	80.2
Queue Delay	0.0	24.6	40.6	0.0	0.2	0.2	0.0
Total Delay	113.5	96.8	100.1	13.4	27.8	27.9	80.2
LOS	F	F	F	B	C	C	F
Approach Delay		98.8	57.5			52.5	
Approach LOS		F	E			D	

Intersection Summary

Cycle Length: 120  
 Actuated Cycle Length: 120  
 Offset: 0 (0%), Referenced to phase 2:EBT and 6:WBT, Start of Yellow, Master Intersection  
 Natural Cycle: 70  
 Control Type: Actuated-Coordinated  
 Maximum v/c Ratio: 1.06  
 Intersection Signal Delay: 71.2  
 Intersection LOS: E  
 Intersection Capacity Utilization 166.4%  
 ICU Level of Service H  
 Analysis Period (min) 15



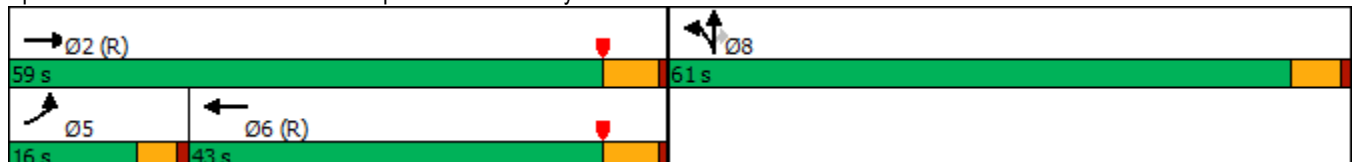





















Splits and Phases: 5: I-215 NB Ramps & Ramona Exwy.



HCM 6th Signalized Intersection Summary  
5: I-215 NB Ramps & Ramona Exwy.

MFBC Building 17 (JN 13697)

09/23/2022

												
Movement	EBL	EBT	EBR	WBL	WBT	WBR	NBL	NBT	NBR	SBL	SBT	SBR
Lane Configurations	 	  			  							
Traffic Volume (veh/h)	320	2316	0	0	1520	1471	906	4	808	0	0	0
Future Volume (veh/h)	320	2316	0	0	1520	1471	906	4	808	0	0	0
Initial Q (Qb), veh	0	0	0	0	0	0	0	0	0			
Ped-Bike Adj(A_pbT)	1.00		1.00	1.00		1.00	1.00		1.00			
Parking Bus, Adj	1.00	1.00	1.00	1.00	1.00	1.00	1.00	1.00	1.00			
Work Zone On Approach		No			No			No				
Adj Sat Flow, veh/h/ln	1900	1900	0	0	1900	1900	1900	1900	1900			
Adj Flow Rate, veh/h	330	2388	0	0	1567	0	937	0	681			
Peak Hour Factor	0.97	0.97	0.97	0.97	0.97	0.97	0.97	0.97	0.97			
Percent Heavy Veh, %	0	0	0	0	0	0	0	0	0			
Cap, veh/h	336	2376	0	0	1684		1615	0	718			
Arrive On Green	0.19	0.92	0.00	0.00	0.32	0.00	0.45	0.00	0.45			
Sat Flow, veh/h	3510	5358	0	0	5358	1610	3619	0	1610			
Grp Volume(v), veh/h	330	2388	0	0	1567	0	937	0	681			
Grp Sat Flow(s),veh/h/ln	1755	1729	0	0	1729	1610	1810	0	1610			
Q Serve(g_s), s	11.2	55.0	0.0	0.0	35.1	0.0	23.2	0.0	48.7			
Cycle Q Clear(g_c), s	11.2	55.0	0.0	0.0	35.1	0.0	23.2	0.0	48.7			
Prop In Lane	1.00		0.00	0.00		1.00	1.00		1.00			
Lane Grp Cap(c), veh/h	336	2376	0	0	1684		1615	0	718			
V/C Ratio(X)	0.98	1.01	0.00	0.00	0.93		0.58	0.00	0.95			
Avail Cap(c_a), veh/h	336	2376	0	0	1684		1674	0	745			
HCM Platoon Ratio	2.00	2.00	1.00	1.00	1.00	1.00	1.00	1.00	1.00			
Upstream Filter(I)	0.62	0.62	0.00	0.00	1.00	0.00	1.00	0.00	1.00			
Uniform Delay (d), s/veh	48.4	5.0	0.0	0.0	39.2	0.0	24.8	0.0	31.9			
Incr Delay (d2), s/veh	33.6	15.8	0.0	0.0	10.7	0.0	0.5	0.0	20.9			
Initial Q Delay(d3),s/veh	0.0	0.0	0.0	0.0	0.0	0.0	0.0	0.0	0.0			
%ile BackOfQ(50%),veh/ln	5.8	5.4	0.0	0.0	15.7	0.0	9.5	0.0	21.8			
Unsig. Movement Delay, s/veh												
LnGrp Delay(d),s/veh	82.0	20.8	0.0	0.0	49.9	0.0	25.3	0.0	52.8			
LnGrp LOS	F	F	A	A	D		C	A	D			
Approach Vol, veh/h		2718			1567			1618				
Approach Delay, s/veh		28.2			49.9			36.9				
Approach LOS		C			D			D				
Timer - Assigned Phs		2			5	6		8				
Phs Duration (G+Y+Rc), s		61.0			16.0	45.0		59.0				
Change Period (Y+Rc), s		6.0			4.5	6.0		5.5				
Max Green Setting (Gmax), s		53.0			11.5	37.0		55.5				
Max Q Clear Time (g_c+I1), s		57.0			13.2	37.1		50.7				
Green Ext Time (p_c), s		0.0			0.0	0.0		2.8				

Intersection Summary

HCM 6th Ctrl Delay	36.4
HCM 6th LOS	D

Notes

User approved volume balancing among the lanes for turning movement.  
Unsignalized Delay for [WBR] is excluded from calculations of the approach delay and intersection delay.

Timings  
3: Harvill Av. & Cajalco Exwy./Ramona Exwy.

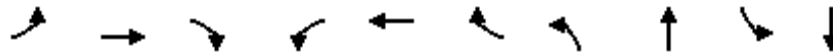

Lane Group	EBL	EBT	EBR	WBL	WBT	WBR	NBL	NBT	SBL	SBT
Lane Configurations	↙	↑↑↑	↘	↙↘	↑↑↑	↘	↙↘	↑↘	↙↘	↑↘
Traffic Volume (vph)	125	1238	297	350	929	477	312	241	920	321
Future Volume (vph)	125	1238	297	350	929	477	312	241	920	321
Turn Type	Prot	NA	Perm	Prot	NA	pm+ov	Prot	NA	Prot	NA
Protected Phases	5	2		1	6	7	3	8	7	4
Permitted Phases			2			6				
Detector Phase	5	2	2	1	6	7	3	8	7	4
Switch Phase										
Minimum Initial (s)	5.0	10.0	10.0	5.0	10.0	5.0	5.0	10.0	5.0	10.0
Minimum Split (s)	9.6	36.2	36.2	9.6	32.5	9.6	9.6	16.2	9.6	41.2
Total Split (s)	17.0	36.9	36.9	16.9	36.8	39.0	22.2	27.2	39.0	44.0
Total Split (%)	14.2%	30.8%	30.8%	14.1%	30.7%	32.5%	18.5%	22.7%	32.5%	36.7%
Yellow Time (s)	3.6	5.2	5.2	3.6	3.5	3.6	3.6	5.2	3.6	5.2
All-Red Time (s)	1.0	1.0	1.0	1.0	1.0	1.0	1.0	1.0	1.0	1.0
Lost Time Adjust (s)	0.0	0.0	0.0	0.0	0.0	0.0	0.0	0.0	0.0	0.0
Total Lost Time (s)	4.6	6.2	6.2	4.6	4.5	4.6	4.6	6.2	4.6	6.2
Lead/Lag	Lead	Lag	Lag	Lead	Lag	Lead	Lead	Lag	Lead	Lag
Lead-Lag Optimize?	Yes	Yes	Yes	Yes	Yes	Yes	Yes	Yes	Yes	Yes
Recall Mode	None	None	None	None	None	None	None	Max	None	Max
Act Effct Green (s)	11.4	30.7	30.7	12.3	33.3	71.9	15.0	21.0	34.1	40.1
Actuated g/C Ratio	0.10	0.26	0.26	0.10	0.28	0.60	0.13	0.18	0.28	0.34
v/c Ratio	0.78	0.91	0.49	1.01	0.63	0.49	0.74	1.45dr	0.96	0.42
Control Delay	82.2	53.5	6.6	103.6	40.2	10.5	60.9	133.2	62.7	25.8
Queue Delay	0.0	0.0	0.0	0.0	0.0	0.0	0.0	0.0	0.0	0.0
Total Delay	82.2	53.5	6.6	103.6	40.2	10.5	60.9	133.2	62.7	25.8
LOS	F	D	A	F	D	B	E	F	E	C
Approach Delay		47.3			44.8			113.5		49.8
Approach LOS		D			D			F		D

Intersection Summary

Cycle Length: 120  
 Actuated Cycle Length: 119.7  
 Natural Cycle: 130  
 Control Type: Actuated-Uncoordinated  
 Maximum v/c Ratio: 1.19  
 Intersection Signal Delay: 59.8  
 Intersection LOS: E  
 Intersection Capacity Utilization 103.9%  
 ICU Level of Service G  
 Analysis Period (min) 15  
 dr Defacto Right Lane. Recode with 1 though lane as a right lane.

Splits and Phases: 3: Harvill Av. & Cajalco Exwy./Ramona Exwy.

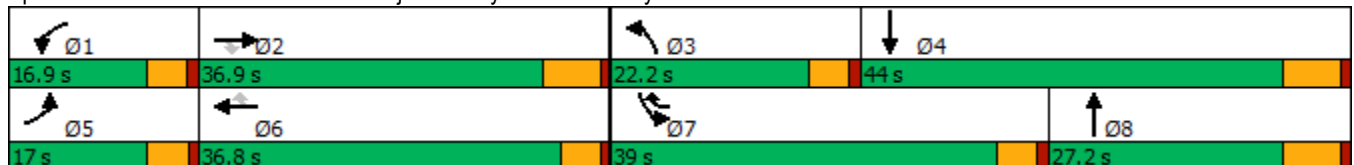



HCM 6th Signalized Intersection Summary  
 3: Harvill Av. & Cajalco Exwy./Ramona Exwy.

MFBC Building 17 (JN 13697)

09/23/2022



Movement	EBL	EBT	EBR	WBL	WBT	WBR	NBL	NBT	NBR	SBL	SBT	SBR
Lane Configurations	↘	↑↑↑	↗	↘↗	↑↑↑	↗	↘↗	↑↑		↘↗	↑↑	
Traffic Volume (veh/h)	125	1238	297	350	929	477	312	241	591	920	321	176
Future Volume (veh/h)	125	1238	297	350	929	477	312	241	591	920	321	176
Initial Q (Qb), veh	0	0	0	0	0	0	0	0	0	0	0	0
Ped-Bike Adj(A_pbT)	1.00		1.00	1.00		1.00	1.00		1.00	1.00		1.00
Parking Bus, Adj	1.00	1.00	1.00	1.00	1.00	1.00	1.00	1.00	1.00	1.00	1.00	1.00
Work Zone On Approach		No			No			No			No	
Adj Sat Flow, veh/h/ln	1900	1900	1900	1900	1900	1900	1900	1900	1900	1900	1900	1900
Adj Flow Rate, veh/h	134	1331	168	376	999	218	335	259	352	989	345	101
Peak Hour Factor	0.93	0.93	0.93	0.93	0.93	0.93	0.93	0.93	0.93	0.93	0.93	0.93
Percent Heavy Veh, %	0	0	0	0	0	0	0	0	0	0	0	0
Cap, veh/h	160	1445	408	374	1532	891	395	336	284	1030	998	288
Arrive On Green	0.13	0.38	0.38	0.16	0.40	0.40	0.16	0.26	0.26	0.43	0.53	0.53
Sat Flow, veh/h	1810	5700	1610	3619	5700	1610	3619	1900	1610	3619	2835	817
Grp Volume(v), veh/h	134	1331	168	376	999	218	335	259	352	989	229	217
Grp Sat Flow(s),veh/h/ln	1810	1900	1610	1810	1900	1610	1810	1900	1610	1810	1900	1753
Q Serve(g_s), s	8.6	26.5	9.1	12.3	16.9	7.4	10.7	15.0	21.0	31.6	8.3	8.5
Cycle Q Clear(g_c), s	8.6	26.5	9.1	12.3	16.9	7.4	10.7	15.0	21.0	31.6	8.3	8.5
Prop In Lane	1.00		1.00	1.00		1.00	1.00		1.00	1.00		0.47
Lane Grp Cap(c), veh/h	160	1445	408	374	1532	891	395	336	284	1030	669	617
V/C Ratio(X)	0.84	0.92	0.41	1.00	0.65	0.24	0.85	0.77	1.24	0.96	0.34	0.35
Avail Cap(c_a), veh/h	189	1472	416	374	1549	896	536	336	284	1047	669	617
HCM Platoon Ratio	1.50	1.50	1.50	1.50	1.50	1.50	1.50	1.50	1.50	1.50	1.50	1.50
Upstream Filter(I)	1.00	1.00	1.00	1.00	1.00	1.00	1.00	1.00	1.00	1.00	1.00	1.00
Uniform Delay (d), s/veh	50.7	35.7	30.3	50.2	31.0	11.0	48.7	41.5	43.7	33.4	20.1	20.2
Incr Delay (d2), s/veh	21.2	9.7	0.7	47.5	1.0	0.1	7.1	15.7	133.3	18.6	1.4	1.6
Initial Q Delay(d3),s/veh	0.0	0.0	0.0	0.0	0.0	0.0	0.0	0.0	0.0	0.0	0.0	0.0
%ile BackOfQ(50%),veh/ln	4.5	11.4	3.3	7.5	6.6	2.2	4.8	7.6	17.7	13.8	3.5	3.3
Unsig. Movement Delay, s/veh												
LnGrp Delay(d),s/veh	71.9	45.4	31.0	97.7	31.9	11.2	55.9	57.2	177.0	52.0	21.5	21.7
LnGrp LOS	E	D	C	F	C	B	E	E	F	D	C	C
Approach Vol, veh/h		1633			1593			946			1435	
Approach Delay, s/veh		46.1			44.6			101.3			42.6	
Approach LOS		D			D			F			D	
Timer - Assigned Phs	1	2	3	4	5	6	7	8				
Phs Duration (G+Y+Rc), s	16.9	36.3	17.6	48.1	15.1	38.2	38.4	27.2				
Change Period (Y+Rc), s	4.6	6.2	4.6	6.2	4.6	* 6.2	4.6	6.2				
Max Green Setting (Gmax), s	12.3	30.7	17.6	37.8	12.4	* 32	34.4	21.0				
Max Q Clear Time (g_c+I1), s	14.3	28.5	12.7	10.5	10.6	18.9	33.6	23.0				
Green Ext Time (p_c), s	0.0	1.7	0.3	2.4	0.0	5.8	0.3	0.0				

Intersection Summary

HCM 6th Ctrl Delay	54.1
HCM 6th LOS	D

Notes

\* HCM 6th computational engine requires equal clearance times for the phases crossing the barrier.



Timings  
4: I-215 SB Ramps & Ramona Exwy.

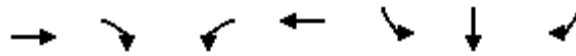

Lane Group	EBT	EBR	WBL	WBT	SBL	SBT	SBR
Lane Configurations	↑↑↑	↑	↔	↑↑↑	↔	↑	↑
Traffic Volume (vph)	1622	899	844	1240	2002	8	418
Future Volume (vph)	1622	899	844	1240	2002	8	418
Turn Type	NA	Perm	Prot	NA	Split	NA	Perm
Protected Phases	2		1	6	4	4	
Permitted Phases		2					4
Detector Phase	2	2	1	6	4	4	4
Switch Phase							
Minimum Initial (s)	5.0	5.0	5.0	5.0	5.0	5.0	5.0
Minimum Split (s)	11.0	11.0	9.5	31.0	10.5	10.5	10.5
Total Split (s)	40.0	40.0	31.0	71.0	49.0	49.0	49.0
Total Split (%)	33.3%	33.3%	25.8%	59.2%	40.8%	40.8%	40.8%
Yellow Time (s)	5.0	5.0	3.5	5.0	4.5	4.5	4.5
All-Red Time (s)	1.0	1.0	1.0	1.0	1.0	1.0	1.0
Lost Time Adjust (s)	0.0	0.0	0.0	0.0	0.0	0.0	0.0
Total Lost Time (s)	6.0	6.0	4.5	6.0	5.5	5.5	5.5
Lead/Lag	Lag	Lag	Lead				
Lead-Lag Optimize?	Yes	Yes	Yes				
Recall Mode	C-Max	C-Max	None	C-Max	Max	Max	Max
Act Effct Green (s)	34.0	34.0	26.5	65.0	43.5	43.5	43.5
Actuated g/C Ratio	0.28	0.28	0.22	0.54	0.36	0.36	0.36
v/c Ratio	1.01	0.98	1.07	0.41	1.04	1.03	0.67
Control Delay	68.7	36.4	116.1	20.6	72.5	80.9	33.0
Queue Delay	0.0	0.0	9.8	0.6	28.9	32.2	0.0
Total Delay	68.7	36.4	125.9	21.2	101.4	113.1	33.0
LOS	E	D	F	C	F	F	C
Approach Delay	57.2			63.6		92.8	
Approach LOS	E			E		F	

Intersection Summary

Cycle Length: 120  
 Actuated Cycle Length: 120  
 Offset: 0 (0%), Referenced to phase 2:EBT and 6:WBT, Start of Yellow  
 Natural Cycle: 130  
 Control Type: Actuated-Coordinated  
 Maximum v/c Ratio: 1.07  
 Intersection Signal Delay: 71.4  
 Intersection LOS: E  
 Intersection Capacity Utilization 165.9%  
 ICU Level of Service H  
 Analysis Period (min) 15

Splits and Phases: 4: I-215 SB Ramps & Ramona Exwy.

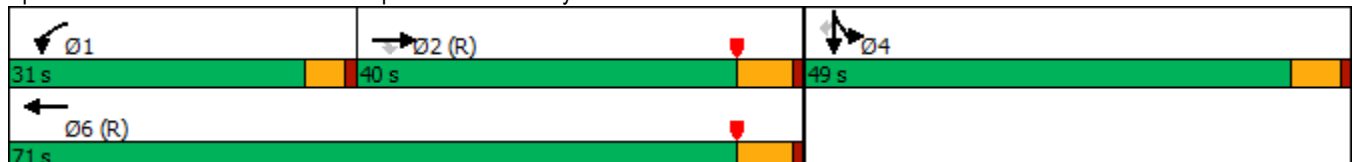

HCM 6th Signalized Intersection Summary  
 4: I-215 SB Ramps & Ramona Exwy.

MFBC Building 17 (JN 13697)

09/23/2022



Movement	EBL	EBT	EBR	WBL	WBT	WBR	NBL	NBT	NBR	SBL	SBT	SBR
Lane Configurations		↑↑↑	↗	↘	↑↑↑					↖	↘	↗
Traffic Volume (veh/h)	0	1622	899	844	1240	0	0	0	0	2002	8	418
Future Volume (veh/h)	0	1622	899	844	1240	0	0	0	0	2002	8	418
Initial Q (Qb), veh	0	0	0	0	0	0				0	0	0
Ped-Bike Adj(A_pbT)	1.00		1.00	1.00		1.00				1.00		1.00
Parking Bus, Adj	1.00	1.00	1.00	1.00	1.00	1.00				1.00	1.00	1.00
Work Zone On Approach		No			No						No	
Adj Sat Flow, veh/h/ln	0	1900	1900	1900	1900	0				1900	1900	1900
Adj Flow Rate, veh/h	0	1638	385	853	1253	0				2028	0	240
Peak Hour Factor	0.99	0.99	0.99	0.99	0.99	0.99				0.99	0.99	0.99
Percent Heavy Veh, %	0	0	0	0	0	0				0	0	0
Cap, veh/h	0	1615	456	799	3088	0				1968	0	584
Arrive On Green	0.00	0.28	0.28	0.22	0.54	0.00				0.36	0.00	0.36
Sat Flow, veh/h	0	5700	1610	3619	5700	0				5429	0	1610
Grp Volume(v), veh/h	0	1638	385	853	1253	0				2028	0	240
Grp Sat Flow(s),veh/h/ln	0	1900	1610	1810	1900	0				1810	0	1610
Q Serve(g_s), s	0.0	34.0	27.0	26.5	15.5	0.0				43.5	0.0	13.4
Cycle Q Clear(g_c), s	0.0	34.0	27.0	26.5	15.5	0.0				43.5	0.0	13.4
Prop In Lane	0.00		1.00	1.00		0.00				1.00		1.00
Lane Grp Cap(c), veh/h	0	1615	456	799	3088	0				1968	0	584
V/C Ratio(X)	0.00	1.01	0.84	1.07	0.41	0.00				1.03	0.00	0.41
Avail Cap(c_a), veh/h	0	1615	456	799	3088	0				1968	0	584
HCM Platoon Ratio	1.00	1.00	1.00	1.00	1.00	1.00				1.00	1.00	1.00
Upstream Filter(I)	0.00	0.24	0.24	0.35	0.35	0.00				1.00	0.00	1.00
Uniform Delay (d), s/veh	0.0	43.0	40.5	46.8	16.2	0.0				38.3	0.0	28.7
Incr Delay (d2), s/veh	0.0	14.7	4.8	39.8	0.1	0.0				28.6	0.0	2.1
Initial Q Delay(d3),s/veh	0.0	0.0	0.0	0.0	0.0	0.0				0.0	0.0	0.0
%ile BackOfQ(50%),veh/ln	0.0	17.3	10.8	15.8	6.2	0.0				23.4	0.0	5.3
Unsig. Movement Delay, s/veh												
LnGrp Delay(d),s/veh	0.0	57.7	45.3	86.6	16.3	0.0				66.8	0.0	30.8
LnGrp LOS	A	F	D	F	B	A				F	A	C
Approach Vol, veh/h		2023			2106						2268	
Approach Delay, s/veh		55.3			44.8						63.0	
Approach LOS		E			D						E	
Timer - Assigned Phs	1	2		4		6						
Phs Duration (G+Y+Rc), s	31.0	40.0		49.0		71.0						
Change Period (Y+Rc), s	4.5	6.0		5.5		6.0						
Max Green Setting (Gmax), s	26.5	34.0		43.5		65.0						
Max Q Clear Time (g_c+I1), s	28.5	36.0		45.5		17.5						
Green Ext Time (p_c), s	0.0	0.0		0.0		6.0						

Intersection Summary

HCM 6th Ctrl Delay	54.6
HCM 6th LOS	D

Notes

User approved volume balancing among the lanes for turning movement.

Timings  
5: I-215 NB Ramps & Ramona Exwy.



Lane Group	EBL	EBT	WBT	WBR	NBL	NBT	NBR
Lane Configurations	↶↶	↶↶↶	↶↶↶	↷	↶	↶	↷
Traffic Volume (vph)	695	2932	1497	1722	590	4	561
Future Volume (vph)	695	2932	1497	1722	590	4	561
Turn Type	Prot	NA	NA	Free	Split	NA	Perm
Protected Phases	5	2	6		8	8	
Permitted Phases				Free			8
Detector Phase	5	2	6		8	8	8
Switch Phase							
Minimum Initial (s)	5.0	5.0	5.0		5.0	5.0	5.0
Minimum Split (s)	9.5	11.0	26.0		10.5	10.5	10.5
Total Split (s)	30.8	76.0	45.2		44.0	44.0	44.0
Total Split (%)	25.7%	63.3%	37.7%		36.7%	36.7%	36.7%
Yellow Time (s)	3.5	5.0	5.0		4.5	4.5	4.5
All-Red Time (s)	1.0	1.0	1.0		1.0	1.0	1.0
Lost Time Adjust (s)	0.0	0.0	0.0		0.0	0.0	0.0
Total Lost Time (s)	4.5	6.0	6.0		5.5	5.5	5.5
Lead/Lag	Lead		Lag				
Lead-Lag Optimize?	Yes		Yes				
Recall Mode	None	C-Max	C-Max		None	None	None
Act Effct Green (s)	26.3	70.0	39.2	120.0	38.5	38.5	38.5
Actuated g/C Ratio	0.22	0.58	0.33	1.00	0.32	0.32	0.32
v/c Ratio	0.96	1.03	0.94	1.15	0.57	0.58	1.06
Control Delay	86.8	50.5	51.2	82.1	38.8	39.0	89.7
Queue Delay	0.0	29.4	31.0	0.0	0.0	0.0	0.0
Total Delay	86.8	79.9	82.3	82.1	38.8	39.0	89.7
LOS	F	E	F	F	D	D	F
Approach Delay		81.2	82.2			63.6	
Approach LOS		F	F			E	

Intersection Summary

Cycle Length: 120  
 Actuated Cycle Length: 120  
 Offset: 0 (0%), Referenced to phase 2:EBT and 6:WBT, Start of Yellow, Master Intersection  
 Natural Cycle: 65  
 Control Type: Actuated-Coordinated  
 Maximum v/c Ratio: 1.15  
 Intersection Signal Delay: 79.0  
 Intersection LOS: E  
 Intersection Capacity Utilization 165.9%  
 ICU Level of Service H  
 Analysis Period (min) 15

Splits and Phases: 5: I-215 NB Ramps & Ramona Exwy.



HCM 6th Signalized Intersection Summary  
5: I-215 NB Ramps & Ramona Exwy.

MFBC Building 17 (JN 13697)

09/23/2022

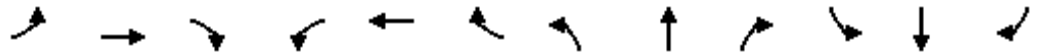

Movement	EBL	EBT	EBR	WBL	WBT	WBR	NBL	NBT	NBR	SBL	SBT	SBR
Lane Configurations	↔↔	↑↑↑			↑↑↑	↔	↔	↑	↔			
Traffic Volume (veh/h)	695	2932	0	0	1497	1722	590	4	561	0	0	0
Future Volume (veh/h)	695	2932	0	0	1497	1722	590	4	561	0	0	0
Initial Q (Qb), veh	0	0	0	0	0	0	0	0	0			
Ped-Bike Adj(A_pbT)	1.00		1.00	1.00		1.00	1.00		1.00			
Parking Bus, Adj	1.00	1.00	1.00	1.00	1.00	1.00	1.00	1.00	1.00			
Work Zone On Approach		No			No			No				
Adj Sat Flow, veh/h/ln	1900	1900	0	0	1900	1900	1900	1900	1900			
Adj Flow Rate, veh/h	739	3119	0	0	1593	0	631	0	516			
Peak Hour Factor	0.94	0.94	0.94	0.94	0.94	0.94	0.94	0.94	0.94			
Percent Heavy Veh, %	0	0	0	0	0	0	0	0	0			
Cap, veh/h	769	3026	0	0	1694		1161	0	517			
Arrive On Green	0.44	1.00	0.00	0.00	0.33	0.00	0.32	0.00	0.32			
Sat Flow, veh/h	3510	5358	0	0	5358	1610	3619	0	1610			
Grp Volume(v), veh/h	739	3119	0	0	1593	0	631	0	516			
Grp Sat Flow(s),veh/h/ln	1755	1729	0	0	1729	1610	1810	0	1610			
Q Serve(g_s), s	24.5	0.0	0.0	0.0	35.8	0.0	17.2	0.0	38.4			
Cycle Q Clear(g_c), s	24.5	0.0	0.0	0.0	35.8	0.0	17.2	0.0	38.4			
Prop In Lane	1.00		0.00	0.00		1.00	1.00		1.00			
Lane Grp Cap(c), veh/h	769	3026	0	0	1694		1161	0	517			
V/C Ratio(X)	0.96	1.03	0.00	0.00	0.94		0.54	0.00	1.00			
Avail Cap(c_a), veh/h	769	3026	0	0	1694		1161	0	517			
HCM Platoon Ratio	2.00	2.00	1.00	1.00	1.00	1.00	1.00	1.00	1.00			
Upstream Filter(I)	0.09	0.09	0.00	0.00	1.00	0.00	1.00	0.00	1.00			
Uniform Delay (d), s/veh	33.2	0.0	0.0	0.0	39.3	0.0	33.5	0.0	40.7			
Incr Delay (d2), s/veh	3.9	15.5	0.0	0.0	11.6	0.0	0.5	0.0	39.3			
Initial Q Delay(d3),s/veh	0.0	0.0	0.0	0.0	0.0	0.0	0.0	0.0	0.0			
%ile BackOfQ(50%),veh/ln	7.5	4.3	0.0	0.0	16.1	0.0	7.4	0.0	20.1			
Unsig. Movement Delay, s/veh												
LnGrp Delay(d),s/veh	37.1	15.5	0.0	0.0	50.9	0.0	34.0	0.0	80.0			
LnGrp LOS	D	F	A	A	D		C	A	F			
Approach Vol, veh/h		3858			1593			1147				
Approach Delay, s/veh		19.6			50.9			54.7				
Approach LOS		B			D			D				
Timer - Assigned Phs		2			5	6		8				
Phs Duration (G+Y+Rc), s		76.0			30.8	45.2		44.0				
Change Period (Y+Rc), s		6.0			4.5	6.0		5.5				
Max Green Setting (Gmax), s		70.0			26.3	39.2		38.5				
Max Q Clear Time (g_c+I1), s		2.0			26.5	37.8		40.4				
Green Ext Time (p_c), s		38.7			0.0	1.0		0.0				

Intersection Summary

HCM 6th Ctrl Delay	33.3
HCM 6th LOS	C

Notes

User approved volume balancing among the lanes for turning movement.  
Unsignalized Delay for [WBR] is excluded from calculations of the approach delay and intersection delay.

**APPENDIX 6.5: EAPC (2025) CONDITIONS FREEWAY OFF-RAMP  
QUEUING ANALYSIS WORKSHEETS WITH IMPROVEMENTS**

This Page Intentionally Left Blank

Queues

4: I-215 SB Ramps & Ramona Exwy.

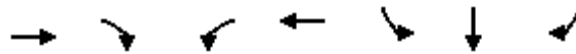

Lane Group	EBT	EBR	WBL	WBT	SBL	SBT	SBR
Lane Group Flow (vph)	801	482	558	1915	1263	624	796
v/c Ratio	0.78	0.71	0.89	0.86	0.68	0.67	0.93
Control Delay	53.4	10.3	83.1	34.0	24.3	26.3	42.9
Queue Delay	0.0	0.0	0.0	36.8	51.3	56.3	0.0
Total Delay	53.4	10.3	83.1	70.9	75.6	82.6	42.9
Queue Length 50th (ft)	200	0	195	305	354	347	518
Queue Length 95th (ft)	245	104	m199	m356	429	482	#804
Internal Link Dist (ft)	1408			344		1111	
Turn Bay Length (ft)		300	100		510		510
Base Capacity (vph)	1023	681	646	2232	1850	928	860
Starvation Cap Reductn	0	0	0	453	0	0	0
Spillback Cap Reductn	0	0	0	0	1108	555	0
Storage Cap Reductn	0	0	0	0	0	0	0
Reduced v/c Ratio	0.78	0.71	0.86	1.08	1.70	1.67	0.93

Intersection Summary

# 95th percentile volume exceeds capacity, queue may be longer.

Queue shown is maximum after two cycles.

m Volume for 95th percentile queue is metered by upstream signal.

Queues

5: I-215 NB Ramps & Ramona Exwy.



Lane Group	EBL	EBT	WBT	WBR	NBL	NBT	NBR
Lane Group Flow (vph)	330	2388	1567	1516	467	471	833
v/c Ratio	0.99	1.04	0.98	0.94	0.59	0.59	1.06
Control Delay	113.5	72.2	59.6	13.4	27.6	27.7	80.2
Queue Delay	0.0	24.6	40.6	0.0	0.2	0.2	0.0
Total Delay	113.5	96.8	100.1	13.4	27.8	27.9	80.2
Queue Length 50th (ft)	135	~713	439	0	274	277	~682
Queue Length 95th (ft)	m#187	#803	#550	#105	390	393	#930
Internal Link Dist (ft)		344	532			1162	
Turn Bay Length (ft)	105			200			500
Base Capacity (vph)	335	2290	1599	1615	793	795	783
Starvation Cap Reductn	0	693	0	0	0	0	0
Spillback Cap Reductn	0	0	264	0	42	42	0
Storage Cap Reductn	0	0	0	0	0	0	0
Reduced v/c Ratio	0.99	1.50	1.17	0.94	0.62	0.63	1.06

Intersection Summary

- ~ Volume exceeds capacity, queue is theoretically infinite.  
Queue shown is maximum after two cycles.
- # 95th percentile volume exceeds capacity, queue may be longer.  
Queue shown is maximum after two cycles.
- m Volume for 95th percentile queue is metered by upstream signal.



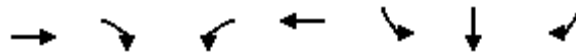

Lane Group	EBT	EBR	WBL	WBT	SBL	SBT	SBR
Lane Group Flow (vph)	1638	908	853	1253	1355	675	422
v/c Ratio	1.01	0.98	1.07	0.41	1.04	1.03	0.67
Control Delay	68.7	36.4	116.1	20.6	72.5	80.9	33.0
Queue Delay	0.0	0.0	9.8	0.6	28.9	32.2	0.0
Total Delay	68.7	36.4	125.9	21.2	101.4	113.1	33.0
Queue Length 50th (ft)	~434	251	~377	177	~564	~559	231
Queue Length 95th (ft)	#535	#568	m#420	m205	#696	#789	350
Internal Link Dist (ft)	1408			344		1111	
Turn Bay Length (ft)		300	100		510		510
Base Capacity (vph)	1615	931	797	3087	1308	656	628
Starvation Cap Reductn	0	0	18	1298	0	0	0
Spillback Cap Reductn	0	0	0	0	681	341	0
Storage Cap Reductn	0	0	0	0	0	0	0
Reduced v/c Ratio	1.01	0.98	1.09	0.70	2.16	2.14	0.67

Intersection Summary

- ~ Volume exceeds capacity, queue is theoretically infinite.  
Queue shown is maximum after two cycles.
- # 95th percentile volume exceeds capacity, queue may be longer.  
Queue shown is maximum after two cycles.
- m Volume for 95th percentile queue is metered by upstream signal.



Lane Group	EBL	EBT	WBT	WBR	NBL	NBT	NBR
Lane Group Flow (vph)	739	3119	1593	1832	314	318	597
v/c Ratio	0.96	1.03	0.94	1.15	0.57	0.58	1.06
Control Delay	86.8	50.5	51.2	82.1	38.8	39.0	89.7
Queue Delay	0.0	29.4	31.0	0.0	0.0	0.0	0.0
Total Delay	86.8	79.9	82.3	82.1	38.8	39.0	89.7
Queue Length 50th (ft)	283	752	437	~384	212	215	~470
Queue Length 95th (ft)	m257	m634	#537	#648	313	317	#696
Internal Link Dist (ft)		344	532			1162	
Turn Bay Length (ft)	105			200			500
Base Capacity (vph)	767	3025	1694	1594	550	551	564
Starvation Cap Reductn	0	1049	0	0	0	0	0
Spillback Cap Reductn	0	0	202	0	0	0	0
Storage Cap Reductn	0	0	0	0	0	0	0
Reduced v/c Ratio	0.96	1.58	1.07	1.15	0.57	0.58	1.06

**Intersection Summary**

- ~ Volume exceeds capacity, queue is theoretically infinite.  
Queue shown is maximum after two cycles.
- # 95th percentile volume exceeds capacity, queue may be longer.  
Queue shown is maximum after two cycles.
- m Volume for 95th percentile queue is metered by upstream signal.