

G. Mixed Use Character Elements

This section of the design guidelines describes how signs and other identity elements will supplement the site planning, landscaping and architectural design in creating a unified sense of place within the core mixed use portions of the Domenigoni-Barton project. In addition to meeting functional needs, the themed pedestrian oriented environments are intended to meet sensory needs through the provision of a network of simple, well-defined and well-proportioned outdoor spaces. This section is intended as a representative palette of design features which are suggested for use within the pedestrian-oriented mixed use areas. The sketches are intended as visual aides in understanding basic intent, allowing flexibility in fulfilling the intended design goals and objectives. Creativity and innovation, as well as consistent quality are encouraged in the implementation of these guidelines.

1. Street Furniture

The arrangement and style of the street furniture are important in creating a sense of place within the mixed-use cores. Style of the street furniture should conform to and complement the Specific Plan themes.

- a. Benches: Purple Heart wood or teak is preferred for its durability in heavy use.
- b. Trash receptacles: Trash cans and ash urns may be constructed of wood materials such as authentic oak barrels. A trash can liner could be placed in a modified Oak barrel by either capping the barrel with an A-frame lid or providing a wood cutout opening in the barrel's side. Natural tone wood materials are preferred. Trash receptacles and ash urns should be combined into one furnishing.



- c. Newspaper Dispenser: Newspaper racks should be built of stained wood. Whenever possible, the number of newspapers per rack container should not exceed three.

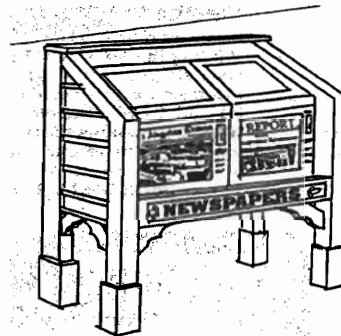

- d. Bike Racks / Hitching Post: Material should be 6" x 6" post of either rough-cut Redwood or pressure-treated Douglas fir with a simple routed design or character on top. Bicycles could be locked to post via a cast iron ring attached securely to the wood.

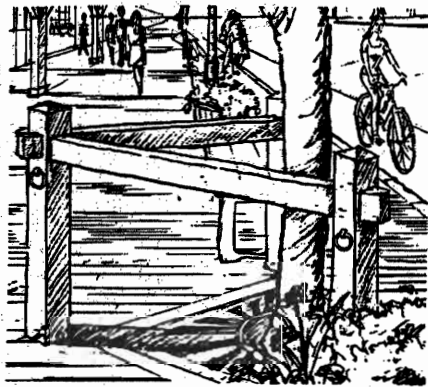

- e. Transit Shelters: Transit shelters should be custom designed and made primarily of wood or adobe-like materials. Metal and plexiglass contemporary designs are strongly discouraged.

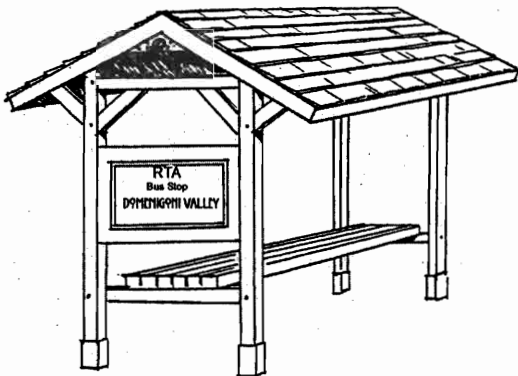

- f. Miscellaneous: Other "period furniture"

which make up the total streetscape should be carefully selected, and in some cases, custom designed in order to maintain the historical theme. These may include:

- Phone booths
- Drinking fountains
- Fire hydrants
- Mailboxes
- Freestanding ATM structures

2. Public Signage

Signs will contribute to the unified appearance of the Domenigoni Ranch. Signs will have a consistent theme that includes support structures, type face, and color palette. Sign elements may be externally or internally illuminated. The placement of signs and their individual messages will be established prior to sign construction and installation.

The communication of information in this sign system is a hierarchical task. The hierarchy is based on communicating the right information in the right place at the right time. In an effort to achieve this goal, zones of information have been created.

- a. Arrival Gateways Monuments: Major gateway monument signs will define the entries into the Domenigoni Ranch from Winchester Road. Surrounded by extensive landscape treatment, these elements should be visible from a distance from vehicles traveling at average speeds on the arterial. Secondary gateway monument signs will define the primary entries into the

Township District and each Village. Design will incorporate a historic California Arts and Crafts theme which incorporates materials simulating aged adobe, naturalistic rock and clinging vines. The intent is to communicate a permanence of place which is much older than the new development.

- b. Pole Signs: Street identification and Standard Department of Transportation regulatory signs, such as stop signs and speed limit signs, should be mounted on sign poles which complement the design character of the Domenigoni Ranch light fixtures. The poles may be simple wood construction, with a Project logo

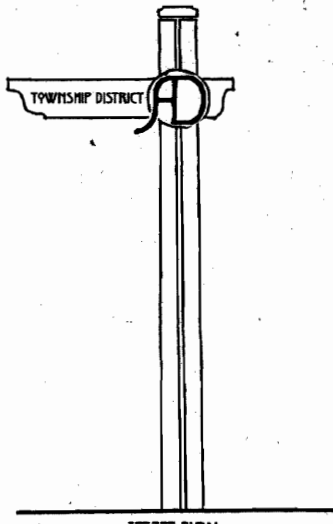

incorporated into the street name placard or pole.

- c. Wayfinding Graphics: Within mixed-use and commercial-recreation areas, pedestrian and vehicular wayfinding signs should be located primarily at

intersections, along parkways. The signs should be free-standing and made of architecturally compatible materials. Illumination and a Project logo should be incorporated. In addition to directional arrows and locations, the overall frame may accommodate a variety of minor sign types: including "You are Here" district maps and informational directories.

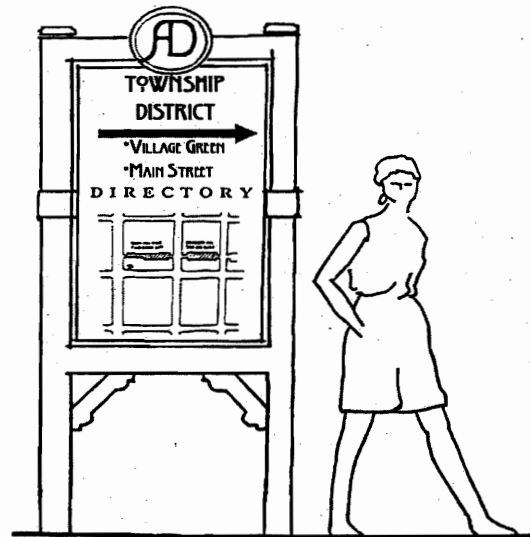

3. Private Signage

Merchant / commercial signs: Within commercial / mixed-use districts, a greater variety of signs is desired, while maintaining the thematic integrity of the Project.

All private signage must comply with Ordinance No. 348 Article XIX "Advertising Regulations" requirements.

a. General guidelines: The guidelines below establish positive criteria for the design of desirable signs which complement the other design elements in the Specific Plan area.

- Use a brief message. The fewer the words, the more effective the sign. A sign with a brief, succinct message is simpler and faster to read, looks cleaner, and is more attractive.
- Avoid faddish, hard-to-read and bizarre typefaces.
- Use significant contrast between the background and letter or symbol colors. If there is little contrast between the brightness or hue of the message of a sign and its background, it will be hard to read.
- Place signs consistent with the proportions of scale of building elements within the façade. Within a building façade, the sign may be placed in different areas. A particular sign may fit well on a plain wall area, but would overpower the finer scale and proportion of the lower storefront. A sign appropriate near the building entry may look tiny and out of place above the ground level.
- Place wall signs to establish façade rhythm, scale and proportion where façade rhythm doesn't exist.
- Use widely recognized logos rather than print / text whenever possible.
- Consider carefully the proportion of letter area to overall sign background area. If letters take up too much sign,

they may be harder to read. Letters should not appear to occupy more than 75% of the sign panel area.

- All private signs shall comply with the provisions of the Americans with Disabilities Act.
 - Identify each building or store's address in 6 inch high numbers, a maximum of three feet over the main entry doorways or within ten feet from the main entry.
 - When a single property has multiple tenants with separate storefronts, multi-tenant wall signs shall either use one consistent typeface for all tenants or use one color for all sign copy. To enhance legibility, the capital letter height and logo of all tenant identification signs shall be the same on a single property.
- a.. Signage Types: Discouraged sign types include internally illuminated signage, billboards, bench signs and neon signs. Preferred private signage types include:
- Canopy / Awning signs – integrated into the front of the awning, occupying 50% or less of the total surface area of the valence.
 - Sign board at upper portion of first story
 - Murals and themed graphics *not* advertising a business (painted on wall surface).
 - Projecting signs – directly attached to building face or suspended from decorative brackets.
 - Figurative signs – uses a graphic or crafted symbol to advertise the occupant's business (eg. Shoes, keys, glasses, etc).
 - Applied window signs – applied to

opaque glass, should not exceed 25% of window area. Temporary paint is unacceptable.

- Monument signs—ground mounted signs in a landscaped setting should be architecturally compatible with Project theme.
- b. Compatibility:
- Sign should relate in size, character and placement to other related elements.
 - Should not obscure architectural elements such as windows, cornices, or decorative elements.
 - Material, style, and color should complement the building façade.
 - Colors should be selected from a limited palette appropriate to the colors of the building and the historic theme.
 - Light sources for externally illuminated signs should be placed carefully to avoid spillover lighting.
 - Lighting hardware should relate to the building façade.
 - Appropriate materials include wood (carved, sandblasted, etched, sealed, primed and painted, stained), metal (formed, etched, cast, engraved, primed and coated).

3. Light Fixtures / Street Pageantry

- a. Street lights: The street light standards for major roadways, minor collectors, as well as local streets should hold to a

consistent theme. An example of an appropriate adaptation of a conventional light standard for the major roadways, includes a tapered, fluted pole with a “Hancock base” and a decorative scroll and finial. A decorative arm with a cobra head light fixture is attached at the top. Within the Township District, along major project entries, and within Commercial-Recreation

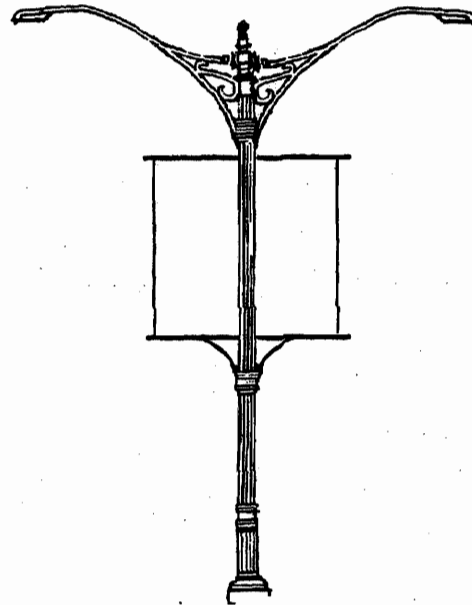

areas, the street lights might provide a removable armature for pageantry, which may include flags, banners, or other similar temporary and permanent (but changeable) elements. The intent is to allow regular changes to the pageantry elements. Banners should be brightly colored, festive and may

be fabricated as sewn or silk-screened on nylon or photo image reproduction on an exterior grade substrate. The intent is that pageantry elements always look current.

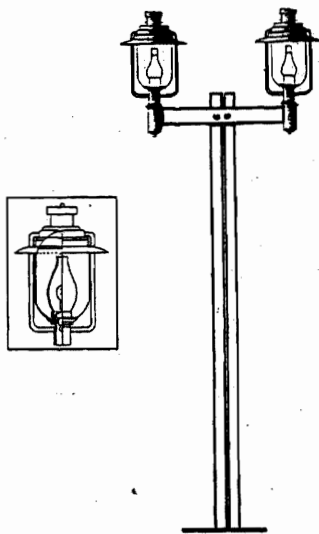

- a. Pedestrian lights: Within mixed use and commercial recreation areas, a simple lantern style light, on a double posted pole (matching the street / regulatory signs) is recommended.

4. Hardscape

- a. Pedestrian: An alternative for the sidewalk / path concept for the Township

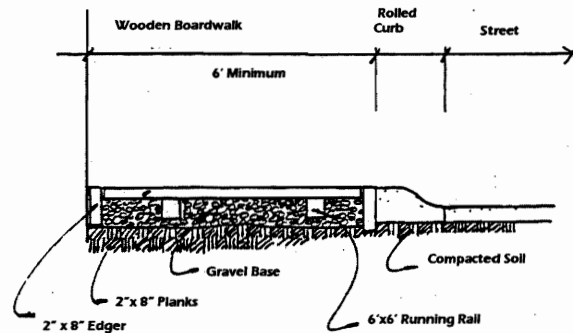

District can be described as a two-tiered system. The first tier of the system is the public sidewalk. The sidewalk would be directly adjacent to the rolling curb, with a minimum width of 6' feet. Wider widths are desirable when feasible. The public sidewalk should be constructed of wood planks. The plank widths should vary in a random arrangement of 6", 8" and 10". The plank sidewalks would be flush with top of the curbs. Colored concrete handicapped ramps will be necessary at corners. The second tier of the system would be privately owned, consisting of converted porches and arcades. The heights (elevations) of the porch/boardwalk should not be greater than 12 inches above the adjacent sidewalk unless greater heights are required because of its flood plane location. The porch would

be open and accessible at both ends to allow continuous pedestrian browsing from one storefront to the next.

Additional paving materials in commercial areas may include wood-formed concrete, brick pavers, and textured colored concrete.

- a. Vehicular: Paving materials in the mixed-use / commercial districts are strongly encouraged to reflect theme integrity wherever possible. Suitable materials include:

- Dark beige colored concrete
- Rustic stone (flagstone)
- River rock
- Stamped deep gray concrete boards
- Textured, stamped concrete that is Terra Cotta with off white grout (to resemble tile)
- Stamped concrete cobbles deep gray in color
- Brick or brick pavers in reds or browns

The number of paving materials and patterns used in one place should be limited. Driveway entries and pedestrian crossings at intersections should be different pavement than sidewalk or street pavement. Vast expanses of concrete or asphalt, as in parking lots, are discouraged and should be modified with differing colors and paving patterns.